

DECOR CELESTIO PENDANT

LEDVANCE

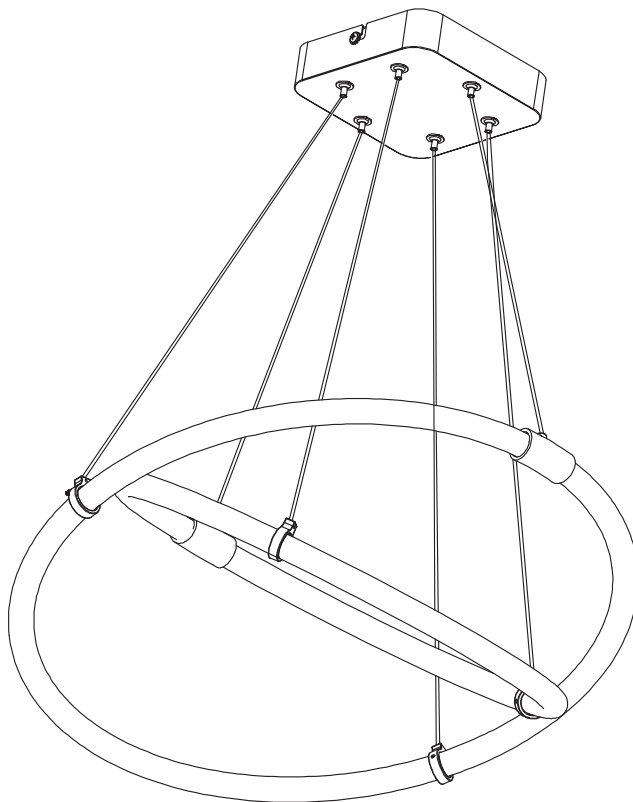





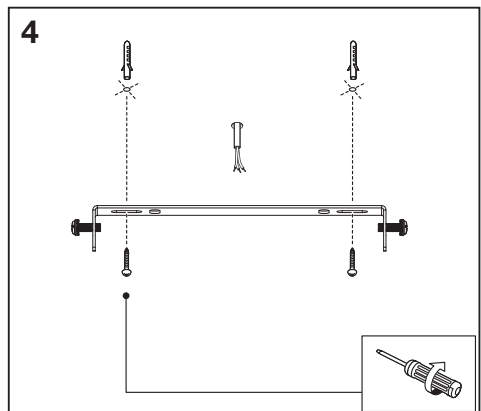
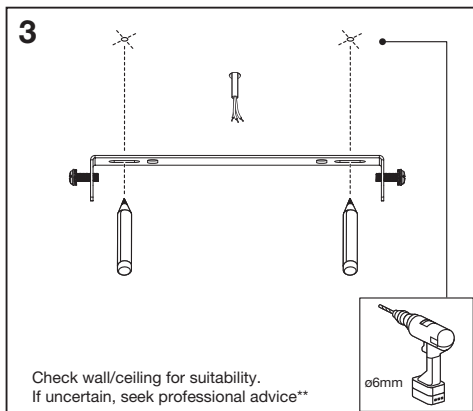
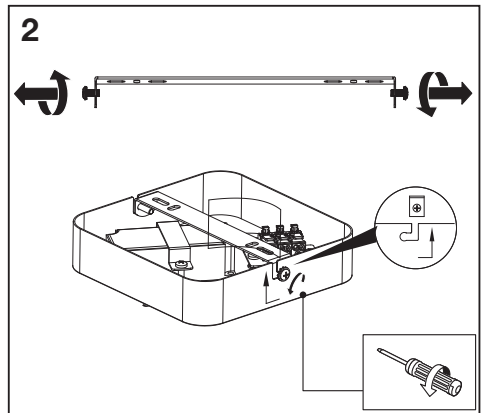
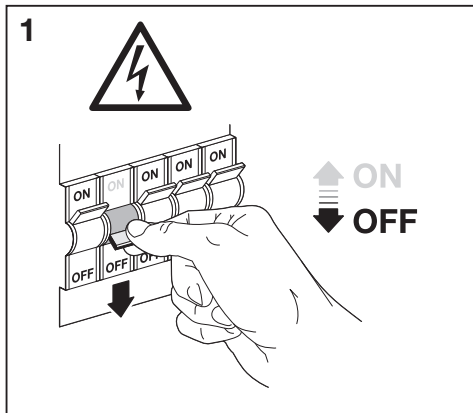
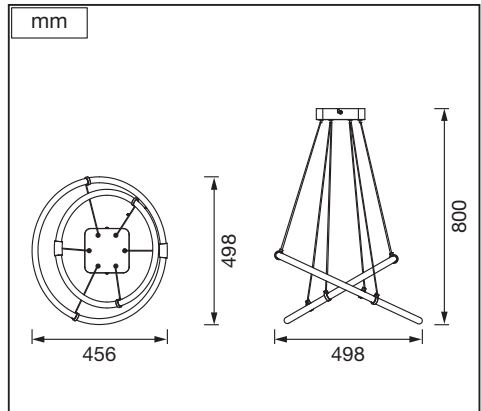
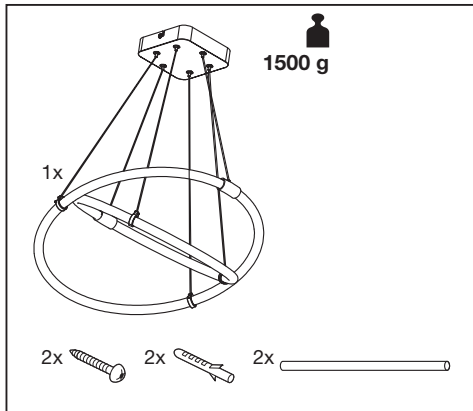

	EAN	W	lm Light Source	lm Output	K	IP	T_{amb} (°C)	V~	mA	Hz	DF	∠ (°)	
DECOR CELESTIO PEND 21W 830 CLICKD	4058075842168	21	3200	2400	3000	20	-20... +40	220- 240	95	50/60	≥0.7	360	20000

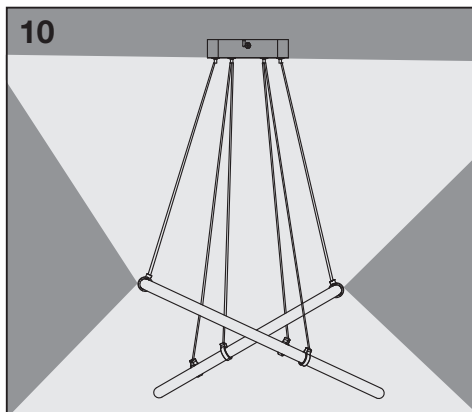
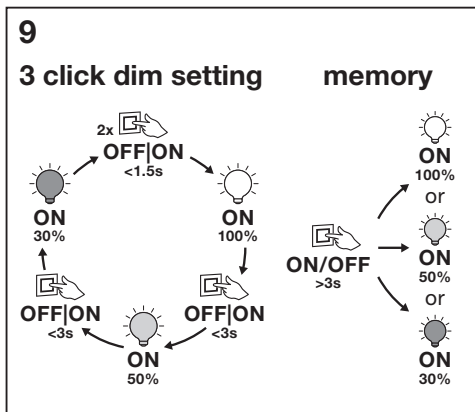
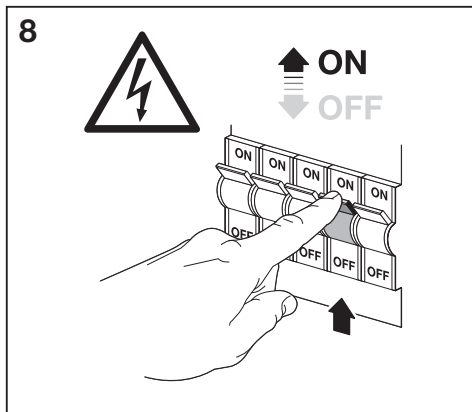
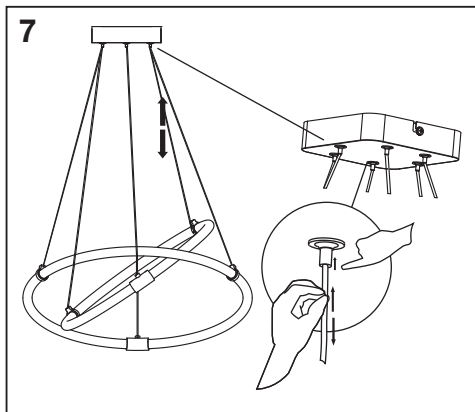
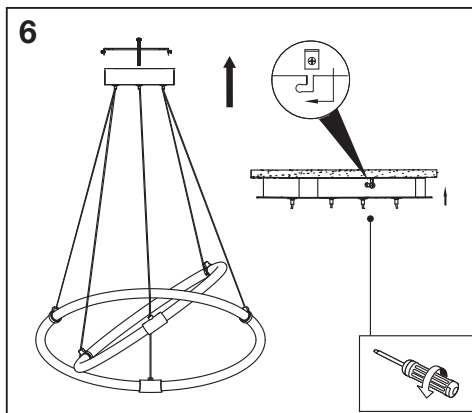
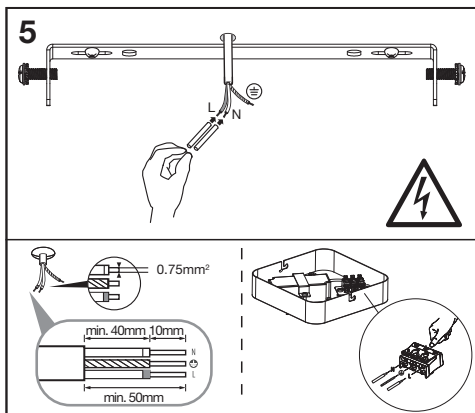

























DECOR CELESTIO PENDANT































DECOR CELESTIO PENDANT







						
		EAN	n			ENERGY * X =
DECOR CELESTIO PEND 21W 830 CLICKD	4058075842168	1	AC63500		D	
		1	AC63506		D	





*  Dieses Produkt enthält eine Lichtquelle der Energieeffizienzklasse <X>.  This product contains a light source of energy efficiency class <X>.  Ce produit contient une source lumineuse de classe d'efficacité énergétique <X>.  Questo prodotto contiene una sorgente luminosa di classe di efficienza energetica <X>.  Este producto contiene una fuente luminosa de la clase de eficiencia energética <X>.  Este produto contém uma fonte de luz da classe de eficiência energética <X>.  Το προϊόν αυτό περιέχει φωτεινή πηγή της τάξης ενεργειακής απόδοσης <X>.  Dit product bevat een lichtbron van energie-efficiëntieklasse <X>.  Tämä tuote sisältää valonlähteen, jonka energiatehokkuusluokka on <X>.  Dette produktet inneholder en lyskilde med energieffektivitetsklasse <X>.  Dette produkt indeholder en lyskilde i energieffektivitetsklasse <X>.  Tento výrobek obsahuje světelný zdroj s třídou energetické účinnosti <X>.  Данный продукт содержит энергосберегающий источник света (класса <X>).  Ez a termék egy <X> energiatérfogatnyúsztályú fényforrást tartalmaz.  Ten produkt zawiera źródło światła o klasie efektywności energetycznej <X>.  Tento výrobok obsahuje svetelný zdroj triedy energetickej účinnosti <X>.  Ta izdelek vsebuje svetlobni vir razreda energetske učinkovitost <X>.  Bu ürün, enerji verimliliği sınıfında bir ışık kaynağı içerir <X>.  Ovaj proizvod sadržiava izvor svetlosti klase energetske učinkovitosti <X>.  Acest produs conține o sursă de lumină cu clasa de eficiență energetică <X>.  Тоzi продукт включва светлинен източник с клас на енергийна ефективност <X>.  Toode sisaldab energiatõhususe klassi <X> valgusallikat.  Šiame gaminyje yra šviesos šaltinis, kurio energijos vartojimo efektyvumo klasė <X>.  Šis s ražojums satur gaismas avotu, kura energoefektivitātes klase ir <X>.  Ovaj proizvod sadrži izvor svetlosti klase energetske efikasnosti <X>.  Цей виріб містить джерело світла класу енергоефективності <X>.  Бұл өнімде <X> энергия тиімділігі классының жарық көзі бар.





**  Eignung der Wand/Decke prüfen. Wenn Sie sich nicht sicher sind, lassen Sie sich beraten.  Vérifiez l'adéquation du mur/plafond. En cas d'incertitude, demandez conseil à un professionnel.  Controllare l'idoneità della parete o del soffitto. In caso di dubbi, consultare un professionista.  Compruebe la idoneidad de la pared o techo. Si no está seguro, busque asesoramiento profesional.  Verifique a adequação da parede/teto. Se não tiver a certeza, procure aconselhamento profissional.  Ελέγξτε τον τοίχο/την οροφή ως προς την καταλληλότητα. Σε περίπτωση αμφιβολίας, ζητήστε επαγγελματική συμβουλή.  Controleer wand/plafond op geschiktheid. Als u niet zeker bent, vraag dan professioneel advies.  Kontrollera vägg/tak för lämplighet. Om du är osäker, sök professionell rådgivning.  Tarkista seinän/katon sopivuus. Jos olet epävarma, kysy neuvoa ammattilaiselta.  Sjekki om veggens/taket egner seg. Oppsøk profesjonell rådgivning dersom du er usikker.  Kontrollér væg/loft for egnethed. Hvis du er usikker, skal du søge professionel rådgivning.  Zkontrolujte vhodnost stěny/stropu. Pokud si nejste jisti, vyhledejte odbornou radu.  Проверьте стену/потолок на пригодность. Если у вас есть сомнения, обратитесь за профессиональной консультацией.  Ellenőrizze a fal/mennyezet alkalmaságát. Ha bizonytalan, kérjen szakember tanácsot.  Sprawdź, czy ściana/sufit nadają się do montażu. W razie wątpliwości zasięgnij porady wykwalifikowanej osoby.  Skontrolujte vhodnost steny/stropu. Ak si nie ste istí, vyhľadajte odbornú pomoc.  Preverite primernost stene/stropa. Če niste prepričani, poiščite nasvet strokovnjaka.  Duvarın/tavanın uygun olup olmadığını kontrol edin. Emin değilseniz uzman bir kişiden destek alın.  Proverite prikladnost zida/stropa. Ako niste sigurni, potražite stručni savjet.  Verificați dacă perețele/tavanul este adecvat. În caz de incertitudine, solicitați consultanță de specialitate.  Προσέρετε προϋποθέστα на стената/тавана. Ако не сте сигурни, потърсете професионален съвет.  Kontrolli seinale/lakke sobivust. Kahtluse korral küsi professionaalilt nõu.  Patikrinkite sienos/Luby tinkamumą. Jei kyla abejonų, kreipkitės į specialistą.  Pārbaudiet sienu/griestu piemērotību. Neskaidrību gadījumā meklējiet profesionālu padomu.  Proverite pogodnost zida/plafona. Ako niste sigurni, potražite stručni savet.  Перевірте відповідність стіни/стелі. Якщо ви не впевнені, зверніться за професійною консультацією.  Қабырғаның/төбениң жарамдылығын тексеріңіз. Егер сенімді болмасаңыз, қасби кеңеске жүгініңіз.

Raccolta Carta

Points de collecte sur www.quefairedemesdechets.fr

C10449057
 G11199030
 01.07.2024



LEDVANCE GmbH
 Steinerne Furt 62
 86167 Augsburg, Germany
www.ledvance.com