

# PRODUCT DATASHEET

## O FACADE BELT RD 11 W 3000 K IP54 GY

OUTDOOR FACADE BELT | Luminaires with modern design and light outlet up and down

---

### Areas of application

- Outdoor
- Building facades
- Entrance lighting



VALUE  
CLASS

---

### Product benefits

- Energy-efficient thanks to LED technology
- 5 years guarantee
- Easy and quick installation
- Homogeneous light output

---

### Product features

- Bright and functional outdoor LED luminaires
- Type of protection: IP54
- Die-cast aluminum housing
- Available in round and square form
- Diffuser made of opal PMMA



## TECHNICAL DATA

### Electrical data

Nominal wattage	11.00 W
Nominal voltage	220...240 V
Mains frequency	50...60 Hz
Nominal current	57 mA
Max. number of luminaires per miniature circuit breaker B16	75
Max. number of luminaires per miniature circuit breaker C10	96
Max. number of luminaires per miniature circuit breaker C16	60
Power factor $\lambda$	> 0.5
Protection class	I
Operating mode	Mains voltage

### Photometrical data

Luminous flux	400 lm
Luminous efficacy	35 lm/W
Color temperature	3000 K
Light color (designation)	Warm White
Color rendering index Ra	$\geq 80$
Standard deviation of color matching	< 6 sdc <sub>m</sub>
Photobiological safety group acc. to EN62778	RG0
Photobiological safety group acc. to EN62471	RG0
Beam angle	335 °

### Dimensions & Weight

Length	60.00 mm
Width	240.00 mm
Height	142.00 mm
Product weight	720.00 g

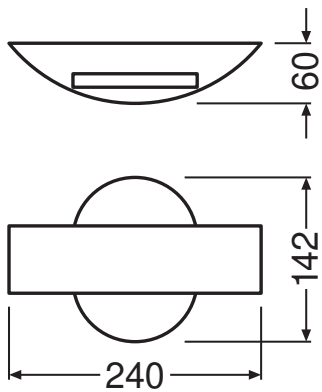

O FACADE BELT RD 11W/3000K  
GY IP54

### Materials & Colors

Product color	Gray
Housing color	Gray
Body material	Aluminum
Cover material	Polymethylmethacrylate (PMMA)
Mercury content	0.0 mg

### Application & Mounting

Ambient temperature range	-20...+40 °C
Type of connection	Screw terminal, 3-Pole
Type of protection	IP54
Protection class IK (shock resistance)	IK06
Dimmable	No
Mounting type	Surface
Mounting location	Wall
Application environment	Outdoor

### Lifespan

Lifespan L70/B50 at 25 °C	30000 h <sup>1)</sup>
Number of switching cycles	15000

<sup>1)</sup> t[h]: L70 / B50 @ 25 °C (Ta), t[h]: L80 / B10 @ 25 °C (Ta), t[h]: L90 / B10 @ 25 °C (Ta)

### Certificates & Standards

Standards	CE
Ball shot safe	No
Replaceable light source (EPREL)	Not replaceable



### EQUIPMENT / ACCESSORIES



- Complete mounting and connecting accessories included

### Safety advice

- All electrical connections must be made by a qualified person.
- Caution, risk of electric shock.

### DOWNLOAD DATA

Documents and certificates	Document name
 User instruction / safety instructions	User Instruction Outdoor Facade Belt Round Square
 On-Pack-Info	Legal Insert OUTDOOR
 Declarations of conformity	EC declararion Outdoor Ledvance

Photometric and lighting design files	Document name
 IES file (IES)	O Facade Belt RD 11W3000K GY IP54
 LDT file (Eulumdat)	O Facade Belt RD 11W3000K GY IP54
 UGR file (UGR table)	O Facade Belt RD 11W3000K GY IP54

### LOGISTICAL DATA

Product code	Packaging unit (Pieces/Unit)	Dimensions (length x width x height)	Gross weight	Volume
4058075074972	Folding box 1	90 mm x 287 mm x 208 mm	880.00 g	5.37 dm <sup>3</sup>
4058075074989	Shipping box 6	600 mm x 220 mm x 290 mm	5616.00 g	38.28 dm <sup>3</sup>

The mentioned product code describes the smallest quantity unit which can be ordered. One shipping unit can contain one or more single products.

When placing an order, for the quantity please enter single or multiples of a shipping unit.

---

### References / Links

– For Guarantee see [www.ledvance.com/guarantee](http://www.ledvance.com/guarantee)

---

### DISCLAIMER

Subject to change without notice. Errors and omission excepted. Always make sure to use the most recent release.