

PRODUCT DATASHEET

HIGH BAY VALUE 150 W 6500 K 100 DEG IP65 BK

HIGH BAY VALUE | High-bay luminaires up to 110 lm/W



Areas of application

- Replacement for high bay luminaires with mercury vapor or metal halide lamps
- Warehouses
- Logistics halls
- Industry
- High ceiling (e.g. in shopping malls, airports, commercial buildings, lobbies)

Product benefits

- Modern exclusive design
- Energy savings of up to 60 % compared to conventional high bay luminaires
- 3 years guarantee
- Optimized weight and size due to compact design

Product features

- Operating temperature: -20...50 °C
- Black aluminum housing, tempered glass cover
- Opal cover
- Type of protection: IP65
- Lifetime (L70): up to 50,000 h
- High luminous efficacy: up to 110 lm/W



TECHNICAL DATA

Electrical data

| | |
|---|---------------|
| Nominal wattage | 150.00 W |
| Nominal voltage | 220...240 V |
| Mains frequency | 50...60 Hz |
| Nominal current | 680 mA |
| Inrush current | 10.3 A |
| Inrush current time T_{h50} | 3.76 μ s |
| Max. number of luminaires per miniature circuit breaker B16 | 18 |
| Max. number of luminaires per miniature circuit breaker C10 | 11 |
| Max. number of luminaires per miniature circuit breaker C16 | 18 |
| Power factor λ | ≥ 0.90 |
| Total harmonic distortion | < 20 % |
| Protection class | I |
| Operating mode | Mains voltage |

Photometrical data

| | |
|--|----------------------|
| Luminous flux | 16000 lm |
| Luminous efficacy | 106 lm/W |
| Color temperature | 6500 K |
| Light color (designation) | Cool Daylight |
| Color rendering index Ra | > 80 |
| Standard deviation of color matching | < 5 sdc _m |
| Photobiological safety group acc. to EN62778 | RG1 |
| Photobiological safety group acc. to EN62471 | RG1 |
| Beam angle | 100 ° |

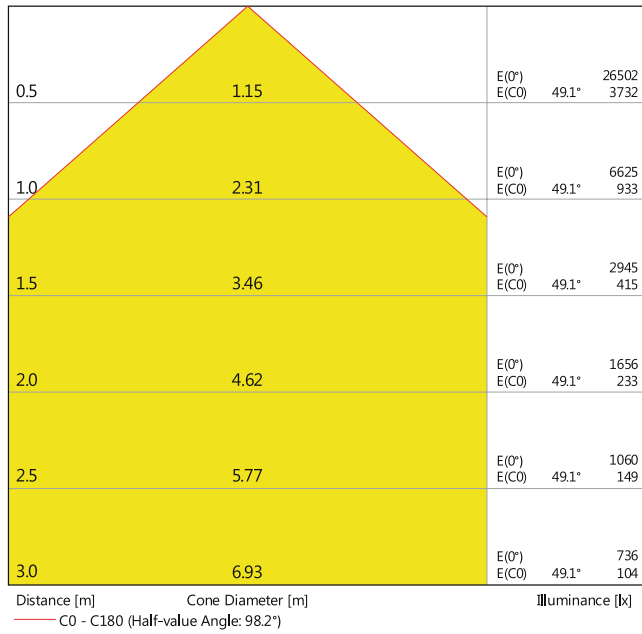

HIGH BAY 150W

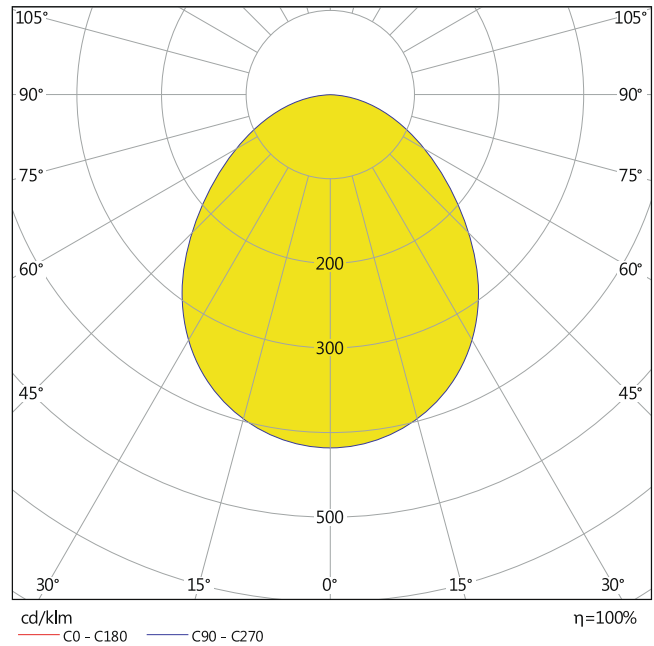

HIGH BAY VALUE 150W

Dimensions & Weight

| | |
|----------------|-----------|
| Diameter | 270.00 mm |
| Height | 51.40 mm |
| Product weight | 1772.00 g |
| Cable length | 500 mm |

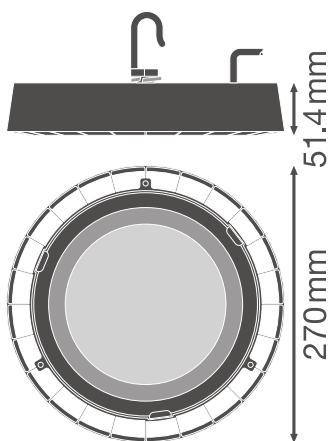

HIGHBAY VALUE 150W

Materials & Colors

| | |
|--|----------------|
| Product color | Black |
| Housing color | Black |
| Body material | Aluminum |
| Cover material | Tempered glass |
| Glow Wire Test according to IEC 60695-2-12 | 650 °C |
| Mercury content | 0.0 mg |

Application & Mounting

| | |
|--|-------------------|
| Ambient temperature range | -20...+50 °C |
| Type of connection | Cable, 3-pole |
| Type of protection | IP65 |
| Protection class IK (shock resistance) | IK06 |
| Dimmable | No |
| Mounting type | Suspended/Surface |
| Mounting location | Ceiling |
| Application environment | Indoor |
| With light source | Yes |
| Replaceable light source | No |

Lifespan

| | |
|----------------------------|-----------------------|
| Lifespan L70/B50 at 25 °C | 50000 h ¹⁾ |
| Lifespan L80/B10 at 25 °C | 32000 h ¹⁾ |
| Lifespan L80/B50 at 25 °C | 36000 h |
| Number of switching cycles | 50000 |

¹⁾ t[h]: L70 / B50 @ 25 °C (Ta), t[h]: L80 / B10 @ 25 °C (Ta), t[h]: L90 / B10 @ 25 °C (Ta)











Certificates & Standards

| | |
|--|-----------------|
| Standards | CE / CB / EAC |
| Luminaire with limited surface temperature, "D sign" | Yes |
| Ball shot safe | No |
| Replaceable light source (EPREL) | Not replaceable |

EQUIPMENT / ACCESSORIES

– Bracket available

DOWNLOAD DATA

| Documents and certificates | | Document name |
|--|--|--|
|  | User instruction / safety instructions | HIGH BAY VALUE USER INSTRUCTION |
|  | Legal information | Legal insert HB VAL AND HB COMP V |
|  | Declarations of conformity | HB VAL |
| Photometric and lighting design files | | Document name |
|  | IES file (IES) | HB VALUE 150W 6500K 100DEG IP65 |
|  | LDT file (Eulumdat) | HB VAL 150W 6500K 100DEG IP65 |
|  | UGR file (UGR table) | HIGH BAY VALUE 150W |
|  | Light distribution curve type cone | HIGH BAY 150W |
|  | Light distribution curve type polar | HIGH BAY VALUE 150W |
| CAD/BIM files | | Document name |
|  | BIM Revit 3D | High Bay Value |
|  | CAD STEP 3D | HB VAL 150W |
| Tender texts | | Document name |
|  | Tender documents | HIGH BAY VALUE 150 W 6500 K 100 DEG IP65 BK-EN |

LOGISTICAL DATA

| Product code | Packaging unit (Pieces/Unit) | Dimensions (length x width x height) | Gross weight | Volume |
|---------------|------------------------------|--------------------------------------|--------------|----------------------|
| 4058075408449 | Shipping box 1 | 297 mm x 297 mm x 89 mm | 2023.00 g | 7.85 dm ³ |

The mentioned product code describes the smallest quantity unit which can be ordered. One shipping unit can contain one or more single products. When placing an order, for the quantity please enter single or multiples of a shipping unit.

ADDITIONAL CATALOG INFORMATION

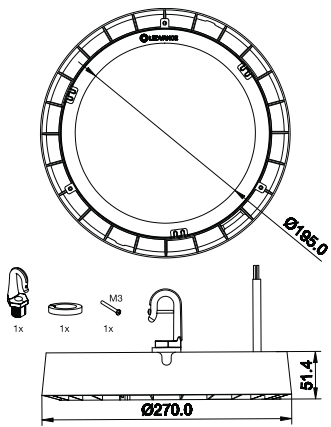

References / Links

– For Guarantee see www.ledvance.com/guarantee

DISCLAIMER

Subject to change without notice. Errors and omission excepted. Always make sure to use the most recent release.