

# PRODUCT DATASHEET

## TR SP ZOOM DIM P 20W 930 WT

TRACKLIGHT SPOT ZOOM DIM | Dimmable 3-phase tracklight spot with mechanical zoom lens and single CCT



### Areas of application

- Direct replacement for luminaires using HID lamps
- Accent lighting
- Galleries, museums
- Shops, changing rooms, shop windows
- Hotels, restaurants

### Product benefits

- Dimmable 3-phase tracklight spot with mechanical zoom lens
- No distraction from the illuminated objects thanks to the reduced design
- Low flicker light thanks to special electronic control gear
- Good glare reduction ( $UGR \leq 19$ )

### Product features

- Mechanical zoom lens with a beam angle of  $18^\circ$  to  $50^\circ$
- Dimmable (3% - 100%) via potentiometer directly on each luminaire
- Color rendering index CRI 90
- Initial color consistency:  $\leq 3$  SDCM
- Rotation angle:  $350^\circ$ , tilt angle:  $90^\circ$
- Durable die-cast aluminum housing
- Available in matt white (like RAL9003), matt black (like RAL9005)
- Luminaire efficacy: up to 120 lm/W



## TECHNICAL DATA

### Electrical data

Nominal wattage	20.00 W
Nominal voltage	220...240 V
Mains frequency	50...60 Hz
Nominal current	500.000 mA
Inrush current	0.56 A
Inrush current time $T_{h50}$	49 $\mu$ s
Max. number of luminaires per miniature circuit breaker B16	140
Max. number of luminaires per miniature circuit breaker C10	87
Max. number of luminaires per miniature circuit breaker C16	140
Power factor $\lambda$	> 0.90
Total harmonic distortion	< 15 %
Protection class	I
Surge capability (L-N)	1000 V
Surge capability (L/N-Ground)	2000 V
Operating mode	Integrated LED driver

### Photometrical data

Luminous flux	2400 lm / 2000 lm <sup>1)</sup>
Luminous efficacy	120 lm/W / 100 lm/W <sup>2)</sup>
Color temperature	3000 K
Light color (designation)	Warm White
Color rendering index Ra	> 90
Standard deviation of color matching	$\leq$ 3 sdcn
Luminous intensity	2700 cd
Low flicker	Yes
Flickering metric (Pst LM)	< 1
Stroboscope effect metric (SVM)	< 0.4
Photobiological safety group acc. to EN62778	RG1
Beam angle	18 °...50 °
UGR	< 24

1) 2400lm@50°, 2000lm@18°

2) 120lm/W@50°, 100lm/W@18°

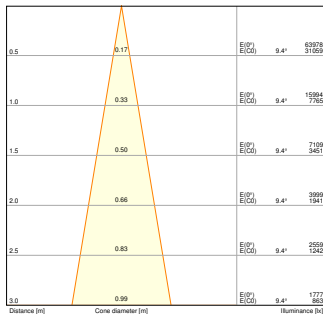

TR SP ZOOM DIM P 20W 930  
WT 18D

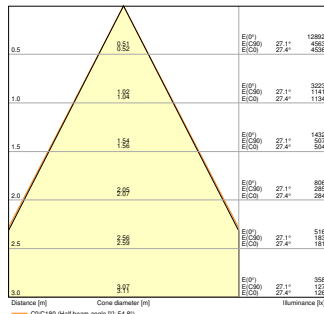

TR SP ZOOM DIM P 20W 930  
WT 50D

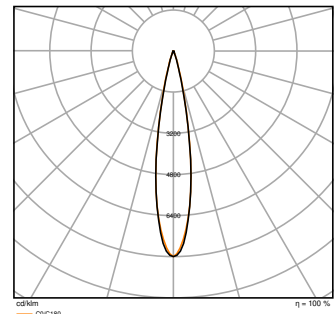

TR SP ZOOM DIM P 20W 930  
WT 18D

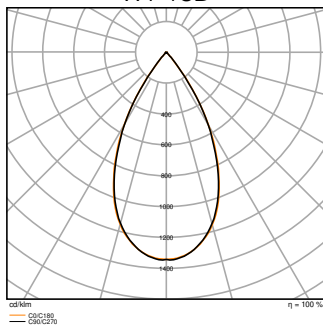

TR SP ZOOM DIM P 20W 930  
WT 50D

Dimensions & Weight

Diameter	72.00 mm
Length	189.00 mm
Height	256.00 mm
Product weight	720.00 g

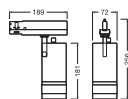

TR SP ZOOM DIM P

Materials & Colors

Product color	White
Housing color	White
Body material	Aluminum

Glow Wire Test according to IEC 60695-2-12	650 °C
Mercury content	0.0 mg

### Application & Mounting

Ambient temperature range	-20...+40 °C
Temperature range at storage	-20...+80 °C
Type of connection	Adapter, 3-phase
Type of protection	IP20/IP20
Protection class IK (shock resistance)	IK03
Dimmable	Yes
Type of dimming	1-10V
Mounting type	Surface
Mounting location	Mounting track
Application environment	Indoor
Adjustable	Yes
With light source	Yes
Replaceable light source	No

### Lifespan

Lifespan L70/B50 at 25 °C	50000 h <sup>1)</sup>
Lifespan L80/B10 at 25 °C	35000 h <sup>1)</sup>
Lifespan L80/B50 at 25 °C	45000 h
Lifespan L90/B10 at 25 °C	25000 h
Number of switching cycles	25000

<sup>1)</sup> t[h]: L70 / B50 @ 25 °C (Ta), t[h]: L80 / B10 @ 25 °C (Ta), t[h]: L90 / B10 @ 25 °C (Ta)

### Control gear

Output current	500 mA
ECG - Output ripple current	< 3 %

### Emergency lighting

Type of emergency operation test	None
----------------------------------	------

### Certificates & Standards

Standards	CE / ENEC / UKCA / EAC
Luminaire with limited surface temperature, "D sign"	No
Ball shot safe	No

Replaceable light source (EPREL)

Not replaceable

## Additional product data

Product remark





Available from September 2025

## Safety advice



- All electrical connections must be made by a qualified person.
- Caution, risk of electric shock.
- Product in protection class I. All electrically conductive, metallic housing parts that can absorb voltage during operation or during maintenance in the event of a fault must be continuously connected to the protective earthing conductor.

## DOWNLOAD DATA

Documents and certificates		Document name
	User instruction / safety instructions	G11247142 TRACKLIGHT SPOT ZOOM DIM
	Legal information	Safety Insert G11218810
	Legal information	Informationstext 18 Abs 4 ElektroG
	Declarations of conformity	TRACKLIGHT SPOT
	Declarations of conformity UKCA	TRACKLIGHT SPOT
	Certificates	ENEC TR SP ZOOM
Photometric and lighting design files		Document name
	IES file (IES)	TR SP ZOOM DIM P 20W 930 WT 18D
	IES file (IES)	TR SP ZOOM DIM P 20W 930 WT 50D
	LDT file (Eulumdat)	TR SP ZOOM DIM P 20W 930 WT 18D
	LDT file (Eulumdat)	TR SP ZOOM DIM P 20W 930 WT 50D
	UGR file (UGR table)	TR SP ZOOM DIM P 20W 930 WT 18D

Photometric and lighting design files		Document name
	UGR file (UGR table)	TR SP ZOOM DIM P 20W 930 WT 50D
	Light distribution curve type cone	TR SP ZOOM DIM P 20W 930 WT 18D
	Light distribution curve type cone	TR SP ZOOM DIM P 20W 930 WT 50D
	Light distribution curve type polar	TR SP ZOOM DIM P 20W 930 WT 18D
	Light distribution curve type polar	TR SP ZOOM DIM P 20W 930 WT 50D

CAD/BIM files		Document name
	BIM Revit 3D	Tracklight Spot Zoom Dim
	CAD STEP 3D	TL ZOOM DIM 20W

**LOGISTICAL DATA**

Product code	Packaging unit (Pieces/Unit)	Dimensions (length x width x height)	Gross weight	Volume
4099854615924	Folding box 1	211 mm x 247 mm x 100 mm	881.00 g	5.21 dm <sup>3</sup>
4099854615931	Shipping box 4	440 mm x 267 mm x 230 mm	4060.00 g	27.02 dm <sup>3</sup>

The mentioned product code describes the smallest quantity unit which can be ordered. One shipping unit can contain one or more single products. When placing an order, for the quantity please enter single or multiples of a shipping unit.

**ADDITIONAL CATALOG INFORMATION**

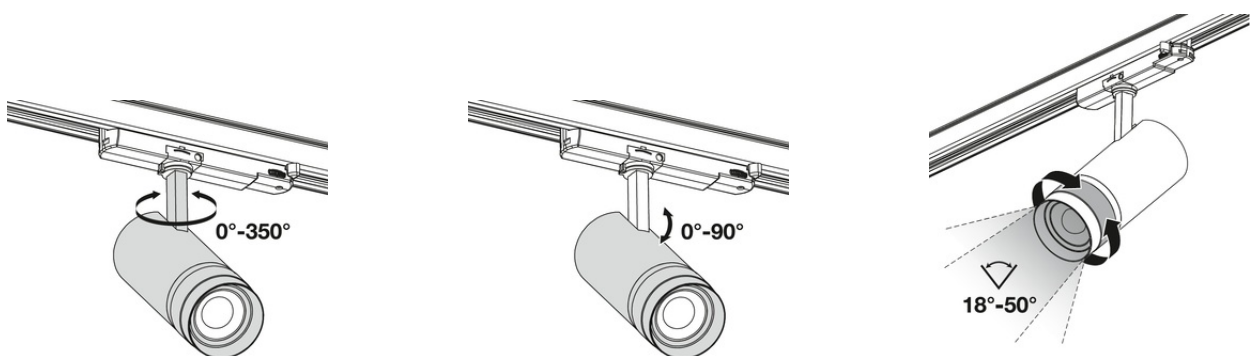

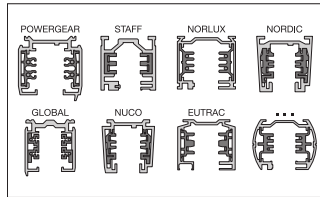
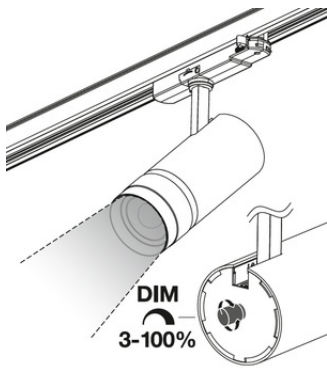

---

**References / Links**

– For Guarantee see [www.ledvance.com/guarantee](http://www.ledvance.com/guarantee)

---

**DISCLAIMER**

Subject to change without notice. Errors and omission excepted. Always make sure to use the most recent release.