

# PRODUCT DATASHEET

## FL FLEX DA P 130W 830 A55X120 WAL

FLOODLIGHT FLEX DALI ASYMMETRIC 55 X 120 | DALI D4i floodlight with wide beam, asymmetric light distribution for various applications



### Areas of application

- Coastal areas, like ports
- General outdoor area lighting
- Parking
- Suitable for indoor and outdoor sports facilities
- Architectural lighting
- Industry
- Direct replacement for luminaires using HID lamps

### Product benefits

- Corrosion resistance C5: tested in environments with high salinity
- Serviceable luminaire: LED driver can be replaced
- Flexible application due to a range of different lumen packages and beam angles
- 3 cable entries for flexible use and easy connection between luminaires
- Integrated breather for preventing condensation inside the luminaire
- Energy savings of up to 91 % compared to halogen lamp floodlights
- Energy savings of up to 51 % compared to luminaires that use conventional discharge lamps
- No upper light output ratio (ULOR 0%) when mounted at 0° tilt
- Intelligent design of the water drain to prevent standing water
- Simple angle adjustment by locking every 2.5°
- Clear angular degree indication
- Key hole to ensure ease of installation

### Product features



- Corrosion resistance C5 based on 1,500 hours salt mist spray test
- High luminous efficacy: up to 156 lm/W
- DALI D4i drivers for smart city applications
- Daisy chaining possible
- High surge protection: up to 10 kV (L/N-PE), 6 kV (L-N)
- High lifetime (L70/B50): up to 120,000 h (at 25 °C)
- Lumen packages up to 70000 lm
- Additional 2200 K color temperature version available

## TECHNICAL DATA

### Electrical data

Nominal wattage	130.00 W
Nominal voltage	220...240 V
Mains frequency	50...60 Hz
Nominal current	586.000 mA
Inrush current	125 A
Inrush current time $T_{h50}$	122 $\mu$ s
Max. number of luminaires per miniature circuit breaker B16	9
Max. number of luminaires per miniature circuit breaker C10	8
Max. number of luminaires per miniature circuit breaker C16	14
Power factor $\lambda$	> 0.90
Total harmonic distortion	< 20 %
Protection class	I
Surge capability (L-N)	6 kV
Surge capability (L/N-Ground)	10 kV
Operating mode	Integrated LED driver
Dimming interface	DALI-2 / IoT

### Photometrical data

Luminous flux	19100 lm
Luminous efficacy	147 lm/W
Color temperature	3000 K
Light color (designation)	Warm White
Color rendering index Ra	> 80
Standard deviation of color matching	5 sdc <sub>m</sub>
Luminous intensity	11722 cd
Low flicker	Yes
Flickering metric (Pst LM)	<1
Stroboscope effect metric (SVM)	<0.4
Photobiological safety group acc. to EN62778	RG1
Beam angle	55 ° x 120 °

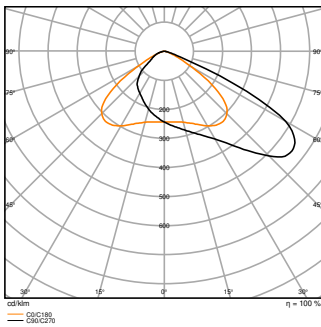

FL FLEX DA P 130W 830 A55X120  
WAL LEDV

### Dimensions & Weight

Length	492.00 mm
Width	361.00 mm
Height	68.00 mm
Product weight	6000.00 g

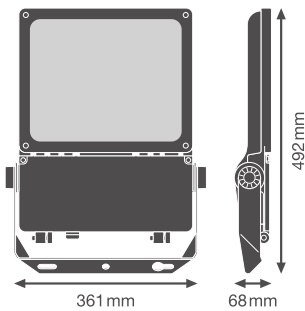

FL FLEX P WAL

### Materials & Colors

Product color	White aluminum
Housing color	White aluminum
Body material	Aluminum
Cover material	Glass
Light emitting surface material	Glass
Glow Wire Test according to IEC 60695-2-12	850 °C

Mercury content	0.0 mg
-----------------	--------

### Application & Mounting

Ambient temperature range	-30...+50 °C
Temperature range at storage	-30...+80 °C
Type of connection	Screwless terminal
Type of protection	IP66
Protection class IK (shock resistance)	IK08
Corrosion resistance class acc. to EN 12944	C5
Dimmable	Yes
Type of dimming	DALI D4i
IoT ready	Support of DALI data type PART 251, 252, 253 <sup>1)</sup>
Mounting type	Surface
Mounting location	Wall / Pole / Floor / Ceiling
Application environment	Outdoor
Adjustable	Yes
With light source	Yes
Replaceable light source	No

<sup>1)</sup> Internet of Things. Supports data transfer via gateway to cloud-based monitoring platforms, such as LEDVANCE VIVARES Cloud

### Lifespan

Lifespan L70/B50 at 25 °C	120000 h <sup>1)</sup>
Lifespan L80/B10 at 25 °C	100000 h <sup>1)</sup>
Lifespan L80/B50 at 25 °C	100000 h
Lifespan L90/B10 at 25 °C	50000 h
Number of switching cycles	100000

<sup>1)</sup> t[h]: L70 / B50 @ 25 °C (Ta), t[h]: L80 / B10 @ 25 °C (Ta), t[h]: L90 / B10 @ 25 °C (Ta)

### Control gear

Output current	4200 mA
ECG - Output ripple current	< 10 %

### Certificates & Standards

Standards	CE / CB / ENEC / UKCA / EPD
Luminaire with limited surface temperature, "D sign"	Yes
EPD	LEDV-00046-V01.01-EN









## Additional product data





Added function	VIVARES
----------------	---------



## EQUIPMENT / ACCESSORIES

- Delivery without cables
- Second cable gland included
- 2 rubber inserts for 6,5 - 7,5 mm cables included

## DOWNLOAD DATA

	Documents and certificates	Document name
	User instruction / safety instructions	FL FLEX P DALI
	Legal information	Informationstext 18 Abs 4 ElektroG
	Legal information	Safety Insert G11205497
	Legal information	LSI FL FLEX DALI
	Legal information	Legal insert G11231557
	Declarations of conformity	CE FL FLEX P
	Declarations of conformity UKCA	UKCA FL FLEX P
	Certificates	ENEC FL FLEX P

	Photometric and lighting design files	Document name
	IES file (IES)	FL FLEX DA P 130W 830 A55X120 WAL LEDV
	LDT file (Eulumdat)	FL FLEX DA P 130W 830 A55X120 WAL LEDV
	ULD file (DIALux)	FL FLEX DA P 130W 830 A55X120 WAL
	ROLF file (RELUX)	FL FLEX DA P 130W 830 A55X120 WAL
	Light distribution curve type polar	FL FLEX DA P 130W 830 A55X120 WAL LEDV

CAD/BIM files		Document name
	BIM Revit 3D	Floodlight Flex
	BIM Step 3D	FL FLEX 130W

Tender texts	Document name
	Tender documents FLOODLIGHT FLEX DALI ASYMMETRIC 55 X 120 130W 830 A55X120 WAL-en

**LOGISTICAL DATA**

Product code	Packaging unit (Pieces/Unit)	Dimensions (length x width x height)	Gross weight	Volume
4099854373336	Shipping box 1	572 mm x 402 mm x 119 mm	7303.00 g	27.36 dm <sup>3</sup>

The mentioned product code describes the smallest quantity unit which can be ordered. One shipping unit can contain one or more single products. When placing an order, for the quantity please enter single or multiples of a shipping unit.

**References / Links**

– For Guarantee see [www.ledvance.com/guarantee](http://www.ledvance.com/guarantee)

**DISCLAIMER**

Subject to change without notice. Errors and omission excepted. Always make sure to use the most recent release.