

PRODUCT DATASHEET

TRUSYS FLEX P 50W 840 WW CL WT EM

TRUSYS FLEX EMERGENCY WALLWASHER | Luminaire inserts with asymmetric wallwasher light distribution for standard and emergency lighting, up to 175 lm/W



Areas of application

- Emergency illumination of escape routes
- Antipanic lighting
- Buildings requiring up to 3 h emergency light operation
- Direct replacement for luminaires with fluorescent lamps
- Industry halls, high rack warehouse, garages, hardware stores

Product benefits

- Seamless integration of luminaires with emergency lighting function into general lighting
- Easy wiring thanks to included prewired driver and battery for Emergency lighting function
- Simple testing of luminaires with emergency lighting function thanks to integrated automatic test function
- Convenient visualization of results of automatic test with an included control LED
- Operation of integrated emergency lighting function with long life LiFePO4 battery with 3h battery discharge time
- High luminous efficacy in normal operation
- 3 years guarantee
- Wall washer light distribution for directed wall illumination
- Easy installation, no tools required for connection
- Energy saving and cost-effective
- Flexible application due to a range of different lumen packages and beam angles

Product features

- Certified according to European norms (EN 60598-1:2015; EN 60598-2-22:2014)



- Luminaire suited for normal lighting and emergency lighting
- Self-contained luminaires
- Emergency lighting function: battery discharge time of 3 h
- Function test of emergency lighting: automatic (AT)
- Battery technology: LiFePO4
- Beam angle wall washer: 1x40°
- Click into place solution with smart click buttons
- Fixed luminaire taps
- Steel-sheet housing

TECHNICAL DATA

Electrical data

Nominal wattage	50.00 W
Nominal voltage	220...240 V
Mains frequency	50...60 Hz
Nominal current	230.000 mA
Inrush current	32 A
Inrush current time T_{h50}	182 μ s
Max. number of luminaires per miniature circuit breaker B16	13
Max. number of luminaires per miniature circuit breaker C10	10
Max. number of luminaires per miniature circuit breaker C16	17
Power factor λ	≥ 0.95
Total harmonic distortion	$\leq 15 \%$
Protection class	I
Operating mode	Integrated LED driver

Photometrical data

Luminous flux	8600 lm
Luminous efficacy	175 lm/W
Color temperature	4000 K
Light color (designation)	Cool White
Color rendering index Ra	≥ 80
Standard deviation of color matching	3 sdc _m
Low flicker	Yes
Flickering metric (Pst LM)	≤ 1
Stroboscope effect metric (SVM)	≤ 0.4
Photobiological safety group acc. to EN62778	RG1
Beam angle	40 °

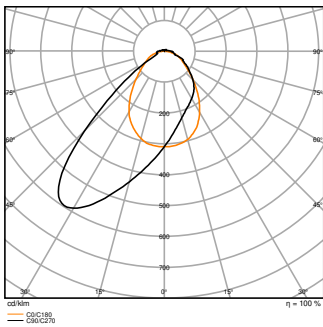

TRUSYS FLEX P 50W 840 WW CL
WT EM

Dimensions & Weight

Length	1500.00 mm
Width	77.70 mm
Height	39.40 mm
Product weight	2360.00 g

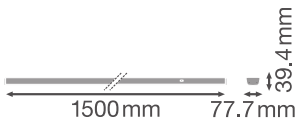

TRUSYS FLEX luminaire - clear

Materials & Colors

Product color	White
Housing color	White
Body material	Steel
Cover material	Polymethylmethacrylate (PMMA)
Light emitting surface material	Polymethylmethacrylate (PMMA)
Glow Wire Test according to IEC 60695-2-12	650 °C

Mercury content	0.0 mg
-----------------	--------

Application & Mounting

Ambient temperature range	0...+40 °C
Temperature range at storage	-40...+80 °C
Type of connection	Plug-In connection
Type of protection	IP40
Protection class IK (shock resistance)	IK04
Dimmable	No
Mounting type	Suspended/Surface
Mounting location	Mounting rail
Application environment	Indoor
Adjustable	No
With light source	Yes

Lifespan

Lifespan L70/B50 at 25 °C	100000 h ¹⁾
Lifespan L80/B10 at 25 °C	76000 h ¹⁾
Lifespan L80/B50 at 25 °C	89000 h
Lifespan L90/B10 at 25 °C	43000 h
Number of switching cycles	100000

¹⁾ t[h]: L70 / B50 @ 25 °C (Ta), t[h]: L80 / B10 @ 25 °C (Ta), t[h]: L90 / B10 @ 25 °C (Ta)

Control gear

Output current	620 mA
ECG - Output ripple current	< 5 %

BATTERY

Type of Battery	LiFePO4
Battery size [GMS]	Others
Nominal voltage of battery	3.2 V
Nominal capacity of battery	9000 mAh
Battery charging time	24 h

Emergency lighting

Area of emergency application	Anti-panic lighting / Escape route lighting
Type of emergency light operation	Non-maintained / Maintained

Type of emergency operation test	Automatic
Wattage in maintained operation mode	50 W
Wattage in emergency operation mode	4 W
Luminous flux in maintained operation mode	8600 lm
Luminous flux in emergency operation mode	740 lm
Battery life in emergency operation mode	3 h









Certificates & Standards







Standards	CE / CB / UKCA / ENEC / EAC
Luminaire with limited surface temperature, "D sign"	Yes
Ball shot safe	No
Replaceable light source (EPREL)	Not replaceable

EQUIPMENT / ACCESSORIES

- Mounting rail with fixed integrated 8-pole cable

DOWNLOAD DATA

Documents and certificates		Document name
	User instruction / safety instructions	TRUSYS FLEX EMERGENCY 840
	Legal information	Legal insert TRUSYS FLEX P EM
	Legal information	LSI TRUSYS FLEX 840 EM
	Legal information	Informationstext 18 Abs 4 ElektroG
	Declarations of conformity	TRUSYS FLEX EM
	Declarations of conformity UKCA	TRUSYS FLEX EM
	Certificates	ENEC Certificate Trusys Flex EM
Photometric and lighting design files		Document name
	IES file (IES)	TRUSYS FLEX P 50W 840 WW CL WT EM

Photometric and lighting design files		Document name
	LDT file (Eulumdat)	TRUSYS FLEX P 50W 840 WW CL WT EM
	ULD file (DIALux)	TRUSYS FLEX P 50W 840 WW CL WT EM
	ROLF file (RELUX)	TRUSYS FLEX P 50W 840 WW CL WT EM
	Light distribution curve type polar	TRUSYS FLEX P 50W 840 WW CL WT EM
CAD/BIM files		Document name
	CAD STEP 3D	TruSys FLEX
Tender texts		Document name
	Tender documents	TRUSYS FLEX EMERGENCY WALLWASHER 50W 840 WW CL WT EM-EN

LOGISTICAL DATA

Product code	Packaging unit (Pieces/Unit)	Dimensions (length x width x height)	Gross weight	Volume
4099854191916	Folding box 1	108 mm x 1,534 mm x 102 mm	2535.00 g	16.90 dm ³
4099854191923	Shipping box 4	1,547 mm x 218 mm x 231 mm	10933.00 g	77.90 dm ³

The mentioned product code describes the smallest quantity unit which can be ordered. One shipping unit can contain one or more single products. When placing an order, for the quantity please enter single or multiples of a shipping unit.

ADDITIONAL CATALOG INFORMATION

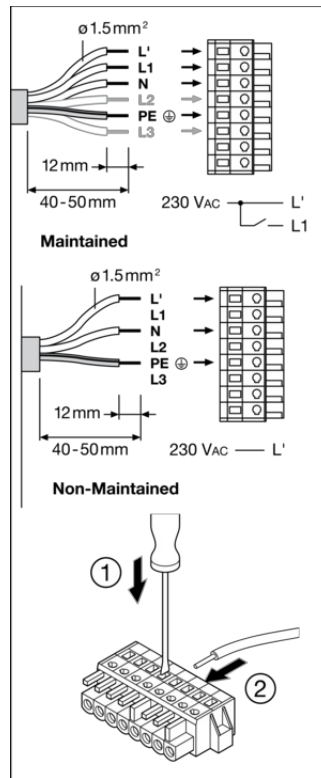

Luminaire Status	Control LED
Normal	Green
Emergency	OFF
Testing	Green: (1s, 1s, 1s ...)
Battery connection fault	Red: (1s, 1s, 1s ...)
Battery capacity fault	Red
Luminaire fault	Red: (4s, 4s, 4s ...)

Test	
Initialization ≥ 48h Normal	Automatic
Daily check of Control LED	Green
Monthly/Weekly functional test (EN 50178) 30s	Automatic test once every 7 days
Yearly duration test (EN 50178) 13h	Automatic test once every 12 weeks

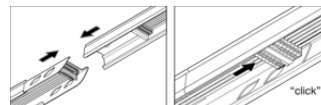

References / Links

– For Guarantee see www.ledvance.com/guarantee

DISCLAIMER

Subject to change without notice. Errors and omission excepted. Always make sure to use the most recent release.