

# PRODUCT DATASHEET

## DP HOUSING 600 P 1XLAMP IP65

DAMP PROOF HOUSING GEN 3 | Damp-proof luminaire for T8 LED lamps with tool-free luminaire connector

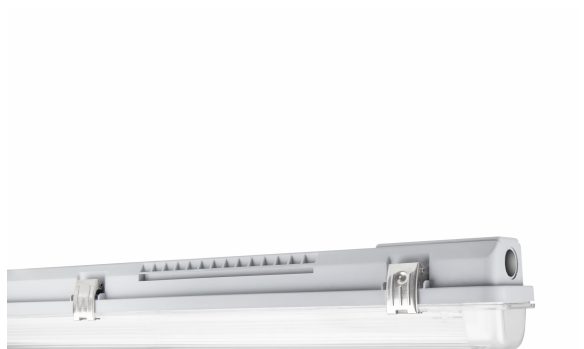

### Areas of application

- Parking lots, warehouses, production areas
- Car parks and underpasses
- Garages

### Product benefits

- Easy and quick installation
- Prewired for easy installation of tubular AC LED lamps
- Toolless installation
- Robust housing
- Sustainable solution thanks to exchangeable light sources
- 5 years guarantee

### Product features

- Luminaire housing, available for 1 or 2 T8 LED tubes
- Suitable for LED TUBE T8 EM and LED TUBE T8 CONNECTED
- Type of protection: IP65
- Integrated electrical fuse



## TECHNICAL DATA

### Electrical data

Nominal voltage	220...240 V
Mains frequency	50...60 Hz
Protection class	II

### Dimensions & Weight

Length	675.00 mm
Width	65.00 mm
Height	70.00 mm
Product weight	420.00 g

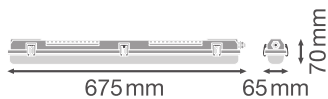

DP HOUSING 600 P 1XLAMP IP65

### Materials & Colors

Product color	Gray
Housing color	Gray
Body material	Polycarbonate (PC)
Cover material	Polycarbonate (PC)
Light emitting surface material	Polycarbonate (PC)
Glow Wire Test according to IEC 60695-2-12	850 °C
Mercury content	0.0 mg

### Application & Mounting

Ambient temperature range	-30...+40 °C
Temperature range at storage	-20...+80 °C

Type of connection	Screwless terminal, 3-Pole (N, E, L)
Type of protection	IP65
Protection class IK (shock resistance)	IK08
Dimmable	No
Mounting type	Surface
Mounting location	Ceiling
Application environment	Indoor
With light source	No
Holder designation	G13

**Certificates & Standards**

Standards	CE / TÜV Rheinland / EAC / UKCA
Luminaire with limited surface temperature, "D sign"	No
Ball shot safe	No





**Additional product data**



Product remark	When used in very cold applications as in cold storage, a special membrane might be required to ensure lifetime
----------------	---

**EQUIPMENT / ACCESSORIES**



- All required accessories included
- Through-wiring cable kit available

**DOWNLOAD DATA**

Documents and certificates		Document name
	User instruction / safety instructions	DP HOUSING
	Legal information	LI DP HOUSING
	Legal information	Informationstext 18 Abs 4 ElektroG
	Declarations of conformity	DP HOUSING
	Declarations of conformity UKCA	DP HOUSING

Photometric and lighting design files		Document name
	IES file (IES)	DP HOUSING 600 P 1xL IP65 incl LEDTUBE CON P 7,5W
	LDT file (Eulumdat)	DP HOUSING 600 P 1xL IP65 incl LEDTUBE CON P 7,5W
	ULD file (DIALux)	DP HOUSING 600 P 1XLAMP IP65

CAD/BIM files		Document name
	BIM Revit 3D	Damp Proof Housing G3
	CAD STEP 3D	DP HOUSING 600 P 1XLAMP IP65

Tender texts		Document name
	Tender documents	DAMP PROOF HOUSING GEN 3 600 P 1XLAMP IP65-EN

**LOGISTICAL DATA**

Product code	Packaging unit (Pieces/Unit)	Dimensions (length x width x height)	Gross weight	Volume
4099854118050	Folding box 1	68 mm x 663 mm x 75 mm	531.00 g	3.38 dm <sup>3</sup>
4099854118067	Shipping box 10	678 mm x 148 mm x 387 mm	6379.00 g	38.83 dm <sup>3</sup>

The mentioned product code describes the smallest quantity unit which can be ordered. One shipping unit can contain one or more single products. When placing an order, for the quantity please enter single or multiples of a shipping unit.

**ADDITIONAL CATALOG INFORMATION**

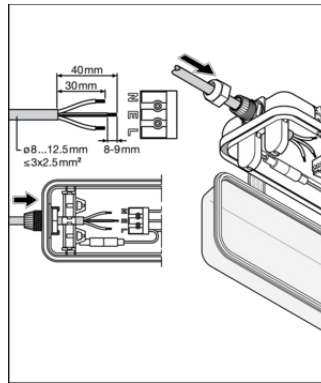
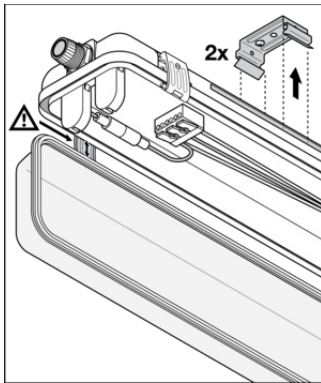

	220-240 V / 50/60 Hz
DP HOUSING 600 P 1XLAMP	1x G13 LED TUBE (0.6 m)
DP HOUSING 600 P 2XLAMP	2x G13 LED TUBE (0.6 m)
DP HOUSING 1200 P 1XLAMP	1x G13 LED TUBE (1.2 m)
DP HOUSING 1200 P 2XLAMP	2x G13 LED TUBE (1.2 m)
DP HOUSING 1500 P 1XLAMP	1x G13 LED TUBE (1.5 m)
DP HOUSING 1500 P 2XLAMP	2x G13 LED TUBE (1.5 m)

### References / Links

– For Guarantee see [www.ledvance.com/guarantee](http://www.ledvance.com/guarantee)

### DISCLAIMER

Subject to change without notice. Errors and omission excepted. Always make sure to use the most recent release.