

# PRODUCT DATASHEET

## PL PFM 625 DALI 30 W 4000 K

PANEL PERFORMANCE 625 DALI | Square recessed panel luminaires, tool-free installation, for 625 x 625 mm ceiling system with DALI-2 IoT technology



### Areas of application

- Direct replacement for luminaires with fluorescent lamps
- Offices, conference rooms
- Reception areas, foyers, corridors, elevators
- Suitable for recessed ceiling systems with grid size of 625 x 625 mm

### Product benefits

- Suitable luminaire for VIVARES and other DALI-2 Light Management Systems
- Tool-free electrical connection due to push button connector
- Through-wiring possible with included connector box
- Energy savings thanks to high system efficacy: up to 120 lm/W
- Comfortable light and high color consistency
- External driver for extended flexibility and easy installation
- Low flicker light thanks to special electronic control gear
- 5 years guarantee

### Product features

- IoT-ready luminaire with DALI-2 technology
- Extruded aluminum frame
- Polystyrene diffuser
- 3-pole terminal block, cable cross section up to 3 x 2.5 mm<sup>2</sup> (25 W and 30 W versions)



- 5-pole terminal block, cable cross section up to  $5 \times 2.5 \text{ mm}^2$  (36 W versions and DALI types)
- Lifetime (L80/B10): up to 60,000 h (at 25 °C)

## TECHNICAL DATA

### Electrical data

Nominal wattage	30.00 W
Nominal voltage	220...240 V
Mains frequency	0/50/60 Hz
Nominal current	135 mA
Inrush current	30 A
Inrush current time $T_{h50}$	200 $\mu$ s
Max. number of luminaires per miniature circuit breaker B16	20
Max. number of luminaires per miniature circuit breaker C10	21
Max. number of luminaires per miniature circuit breaker C16	33
Power factor $\lambda$	> 0.95
Total harmonic distortion	< 10 %
Protection class	II
Operating mode	External LED driver
Dimming interface	DALI-2/loT

### Photometrical data

Luminous flux	3600 lm
Luminous efficacy	120 lm/W
Color temperature	4000 K
Light color (designation)	Cool White
Color rendering index Ra	> 80
Standard deviation of color matching	3 sdc <sub>m</sub>
Luminous intensity	-
Low flicker	Yes
Flickering metric (Pst LM)	-
Stroboscope effect metric (SVM)	-
Photobiological safety group acc. to EN62778	RG0
Photobiological safety group acc. to EN62471	RG0
Beam angle	120 °
UGR	< 22

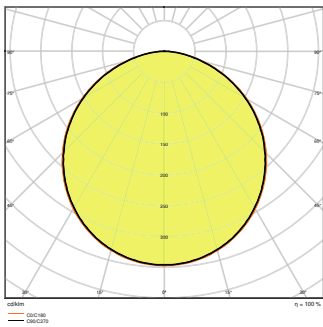

PL PFM 625 DALI 30W4000K

### Dimensions & Weight

Length	620.00 mm
Width	620.00 mm
Height	32.00 mm
Product weight	1900.00 g

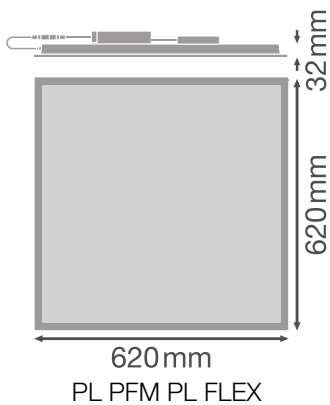

### Materials & Colors

Product color	White
Housing color	White
Body material	Steel
Cover material	Polystyrene (PS)
Light emitting surface material	Polystyrene
Glow Wire Test according to IEC 60695-2-12	650 °C

Mercury content	0.0 mg
-----------------	--------

### Application & Mounting

Ambient temperature range	-10...+50 °C
Type of connection	Screwless terminal, 5-Pole (L, N, PE, DA+, DA-)
Type of protection	IP40/IP20
Protection class IK (shock resistance)	IK02
Dimmable	Yes
Type of dimming	DALI
Mounting type	Recessed/Suspended/Surface
Mounting location	Ceiling / Wall
Application environment	Indoor
Mounting length	600,0 mm
Mounting width	600,0 mm
Mounting depth	80,0 mm
With light source	Yes

### Lifespan

Lifespan L70/B50 at 25 °C	100000 h <sup>1)</sup>
Lifespan L80/B10 at 25 °C	60000 h <sup>1)</sup>
Lifespan L80/B50 at 25 °C	60000 h
Lifespan L90/B10 at 25 °C	35000 h
Number of switching cycles	50000

<sup>1)</sup> t[h]: L70 / B50 @ 25 °C (Ta), t[h]: L80 / B10 @ 25 °C (Ta), t[h]: L90 / B10 @ 25 °C (Ta)

### Control gear

Output current	660 mA
ECG - Output ripple current	< 3 %













### Certificates & Standards

Standards	CE / CB / ENEC / EAC
Luminaire with limited surface temperature, "D sign"	No
Ball shot safe	No
Replaceable light source (EPREL)	Not replaceable

### EQUIPMENT / ACCESSORIES

- Accessories for several mounting options available
- Connector box with 3-pole or 5-pole terminal included
- Security brackets included
- External control gear included
- Not suitable for use with Emergency Conversion Box

## DOWNLOAD DATA

Documents and certificates		Document name
	User instruction / safety instructions	PANEL PERFORMANCE 600/625 DALI
	Legal information	LSI PL PFM AND PL PFM DALI
	Legal information	LSI PL PFM AND PL PFM DALI
	Declarations of conformity	PL PFM DALI 30W
Photometric and lighting design files		Document name
	IES file (IES)	PL PFM 625 DALI 30W 4000K
	LDT file (Eulumdat)	PL PFM 625 DALI 30W4000K
	ULD file (DIALux)	PL PFM 625 DALI 30W-4000K
	ROLF file (RELUX)	PL PFM 625 DALI
	UGR file (UGR table)	PL PFM 625 DALI 30W4000K
	Light distribution curve type polar	PL PFM 625 DALI 30W4000K
CAD/BIM files		Document name
	BIM Revit 3D	PL PFM gen3
	CAD STEP 3D	PL PFM gen3 625
Tender texts		Document name
	Tender documents	PANEL PERFORMANCE 625 DALI 30 W 4000 K-EN

---

**LOGISTICAL DATA**

Product code	Packaging unit (Pieces/Unit)	Dimensions (length x width x height)	Gross weight	Volume
4058075538191	Folding box 1	52 mm x 647 mm x 719 mm	2420.00 g	24.19 dm <sup>3</sup>
4058075538207	Shipping box 4	665 mm x 220 mm x 735 mm	11048.00 g	107.53 dm <sup>3</sup>

The mentioned product code describes the smallest quantity unit which can be ordered. One shipping unit can contain one or more single products. When placing an order, for the quantity please enter single or multiples of a shipping unit.

---

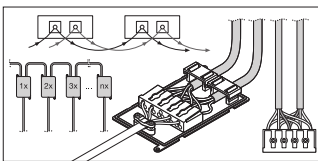
**ADDITIONAL CATALOG INFORMATION**

---

**References / Links**

– For Guarantee see [www.ledvance.com/guarantee](http://www.ledvance.com/guarantee)

---

**DISCLAIMER**

Subject to change without notice. Errors and omission excepted. Always make sure to use the most recent release.