



LEDVANCE LIGHTING SOLUTIONS V2

CONTACT US



Head Office
LEDVANCE Pty Ltd
Unit 3, 83 Derby St
Silverwater NSW 2128
Australia

LEDVANCE.COM.AU

Customer Service
1300 467 726
Sales.au@ledvance.com



LEDVANCE is awarded signatory statuses in recognition for its support for



FluoroCycle











































EXITCYCLE

CONTENTS

CONTENTS	1	FLOODLIGHT	115
ICON GLOSSARY	2	TRI COLOUR MULTI WATTAGE FLOODLIGHT - LOW POWER	116
FULL RANGE, STRONG BENEFITS	3	TRI COLOUR MULTI WATTAGE FLOODLIGHT - MID POWER	120
COLOUR TEMPERATURE	4	HIGH POWER FLOODLIGHT	124
BRIGHTNESS & LUX LEVELS	5	FLOODLIGHT MAX	128
MACADAM ELLIPSE (SDCM), COLOUR RENDERING AND UGR	6	SECURITY FLOODLIGHT	132
IP RATING & IK RATING	7	BULKHEAD AND OYSTER	137
IC RATING	8	ORBIS ULTRA SLIM OYSTER	138
FLUOROCYCLE & EXITCYCLE	9	TRI COLOUR OYSTER	142
SAFETY AND PERFORMANCE	10	IP65 BULKHEAD	146
DOWNLIGHT	13	SENSOR, DIMMER AND ECG	151
SUPERSTAR DOWNLIGHT	14	PIR AND MICROWAVE SENSORS	152
SUPERSTAR TRI COLOUR GIMBLE DOWNLIGHT	18	VALUE DIMMERS	160
SUPERSTAR GIMBLE DOWNLIGHT	22	IP20 ELECTRONIC TRANSFORMER 60W	162
SUPERSTAR SLIM DOWNLIGHT	26	STREET LIGHTING	165
MODULAR DOWNLIGHT	30	ECO SOLAR STREETLIGHT	166
COMMERCIAL DOWNLIGHT	36	SOLAR STREETLIGHT	170
SURFACE MOUNT DOWNLIGHT	40	STREETLIGHT FLEX	174
ULTRA COMMERCIAL DOWNLIGHT	44	THESEUS	178
LED PANEL	49	TRADITIONAL LAMP	183
ECO PANEL	50	COMPACT FLUORESCENT LAMP	184
PANEL PLUS	54	FLUORESCENT LAMP	189
HIGH OUTPUT PANEL	58	METAL HALIDE LAMP	193
SURFACE MOUNT FRAME	62	HIGH PRESSURE SODIUM LAMP	195
UNIVERSAL PANEL ACCESSORIES	64	INCANDESCENT LAMP	197
LINEAR	67	HALOGEN LAMP	198
TRI COLOUR MULTI WATTAGE BATTEN - SLIM	68	INFRARED LAMP	202
TRI COLOUR MULTI WATTAGE BATTEN - WIDE	72	LED LAMP	205
BLADE BATTEN	76	LED LAMP WITH TRUWAVE TECHNOLOGY™	206
LINKABLE BATTEN	80	CLASSIC SHAPE LED LAMP	217
MINI BATTEN	84	REFLECTOR LED LAMP	218
WEATHERPROOF	89	SPECIALIST LED LAMP	219
WIDE WEATHERPROOF BATTEN	90	HQL LED & DULUX LED	220
TRI COLOUR MULTI WATTAGE WEATHERPROOF BATTEN	94	NAV LED LAMP	221
HIGHBAY AND CANOPY LIGHT	99	LED TUBE	222
TRI COLOUR MULTI WATTAGE HIGHBAY	100	WARRANTY POLICY	223
PERFORMANCE HIGHBAY	106	PRODUCT WARRANTY	225
CANOPY LIGHT	110		

ICON GLOSSARY

	Adjustable Colour Temperature		Wattage(W)		Voltage(V)
	Dimmable		Lumen		Colour Rendering Index
	IP Ingress Protection Rating		Colour Temperature(K)		Lifetime(hours)
	IK Impact Rating		Beam Angle(°)		Product Class
	Colour Rendering Index		Lumen Efficacy		
	Uniform Glare Rating		Cut Out Size(mm)		
	Insulation Contact Rating		Dimmable		
	Flex and Plug		Diameter(mm)		
	Motion Sensor		Length(mm)		
	With Solar Panel		Width(mm)		
	Rechargeable Lithium Battery Included		Height(mm)		
	USB Charging Cable Included		Weight(g)		
	UV-C		Emergency Duration Time(minutes)		
	Double Insulated		Product Colour		
	Emergency Symbol		Max Installation Height(m)		
	Lifetime		Image Number		
	Warranty		Base		

FULL RANGE, STRONG BENEFITS

OUR NEW LED LUMINAIRE PORTFOLIO

We proudly offer high quality lighting solutions that are both easy to install and highly functional. Our products are reliable, affordable, and offer great value, ensuring that you have access to the ideal lighting for your needs. At LEDVANCE, we make your day-to-day work easier and more successful with our comprehensive LED luminaires portfolio!

You set the highest standards in terms of light quality. We offer you the opportunity to entirely meet those demands with our LED luminaires portfolio. We have developed numerous new product features to make your day-to-day work easier. Case in point? With TRI Colour Superstar Downlights, you can now easily set any of three different light colour simply by using a DIP switch.

NEED YOUR PRODUCTS THE NEXT DAY?

Here at LEDVANCE we understand the importance of a speedy freight service to keep our valued customers happy, with this we are proud to offer next day delivery service to metro Sydney, Brisbane and Perth areas (subjective to stock holdings, all orders to be placed before 12pm AEST).

We are active in over 140 countries, catering to specific demands and assisting customers with our teams of experts.

FUNCTIONAL LUMINAIRES FOR SUCCESSFUL LIGHTING PROJECTS

All luminaires are characterised by their easy installation, outstanding price/performance ratio and modern designs. They comply with all the applicable standards and regulations and possess all the relevant certificates and approvals. The LED luminaires are equipped exclusively with high-quality LED modules in the highest energy efficiency classes (A, A+ and A++).

DO YOU NEED VERSATILE AND MODERN LIGHTING SOLUTIONS FOR DIFFERENT APPLICATIONS?

Our extensive portfolio of LED luminaires offers ideal lighting solutions in a variety of different applications. Efficient, easy to install and durable products in a modern design. Make your choice - and be inspired!

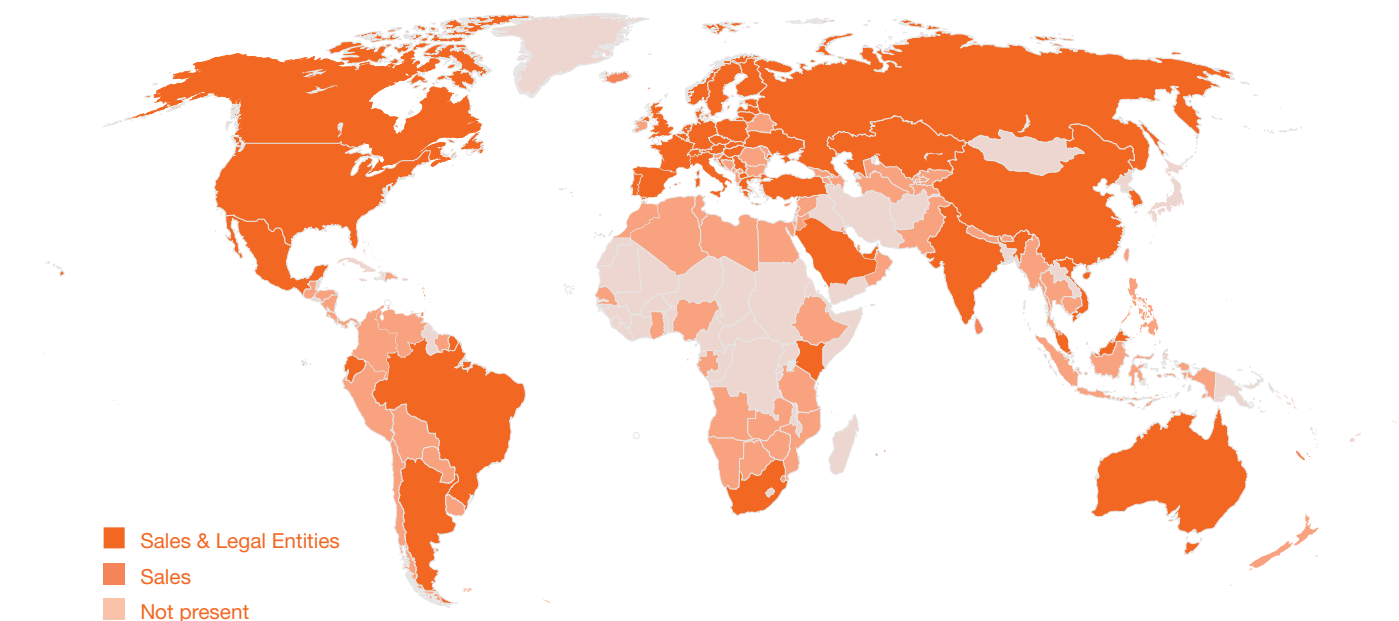

COLOUR TEMPERATURE

COLOUR TEMPERATURE

When choosing your correlated colour temperature (CCT) personal preference, mood and application are generally the most common factors that are taken into consideration, to ensure the highest level of visual comfort. Generally LED lights vary from 2700K – 6500K. The lower the Kelvin, the warmer the tone, for example, if a traditional halogen lamp colour is desired, the preferred colour temperature would be 2700K-3000K. These are typically used for residential applications such as the bedroom or as mood lighting in restaurants to create a cosy and ambient feel. 4000K-5000K (described as a cool/natural white) is commonly used in work areas, kitchens and bathrooms to improve alertness and to create a crisp, clean looking space. Daylight is often described as 5000K+, which creates a white/blue illumination which replicates that from natural light on a sunny day, commonly used in commercial applications.

Other factors to consider when considering your ideal LED colour temperature:

- Colour scheme
- Consistency throughout the area
- Mood of the space
- Purpose of the area



BRIGHTNESS & LUX LEVELS

When it comes to LED's the main factor to consider regarding the desired brightness, is the lumen output rather than the Wattage (efficacy of the luminaire). Lumens measure the total light output of a fitting, the higher the lumen, the brighter the light. As the technology of LED has improved over time, the light emitted can be up to 5 times brighter than traditional globes with a saving of up to 50% in energy bills.

Another method to determine the brightness of an area is to create a lighting design in order to calculate the lux levels. Lux is a measurement of light level intensity, also known as illuminance. This is calculated per square meter of the area. The standard requirements of lux levels in order to obtain safe movement are outlined in ASNZ 1680.

Another easy way to calculate the approximate lux levels of your area is to use a simple maths formula (floor illumination from a ceiling no higher than 3m) If you have a space which is 10x5m and you wish to use our Superstar Downlight 7.5w (820lm) you can

determine how many luminaires you require based on the below:

$$10\text{m} \times 5\text{m} = 50\text{m}^2$$

$$820(\text{lm}) / 50(\text{m}^2) = 16.4 \text{ lux}$$

In accordance to ASNZ 1680-2.1 the recommended lux level within a general dining area is 160 lux. Based on using 1 of our 7.5W downlight you are currently only illuminating the area with around 16 lux.

$$160 \text{ (desired lux levels)} / 16.4 \text{ (current lux levels of the } 50\text{m}^2 \text{ area)} = 9.75 \text{ (rounded up to 10 downlights)}$$

In order to achieve a lux level of 160 you would require 10 of our downlights at 820lm as generally speaking you would round the number of luminaires up to an even quantity.

Check out ledvance.com.au to use the simple fast light room calculation tool available.

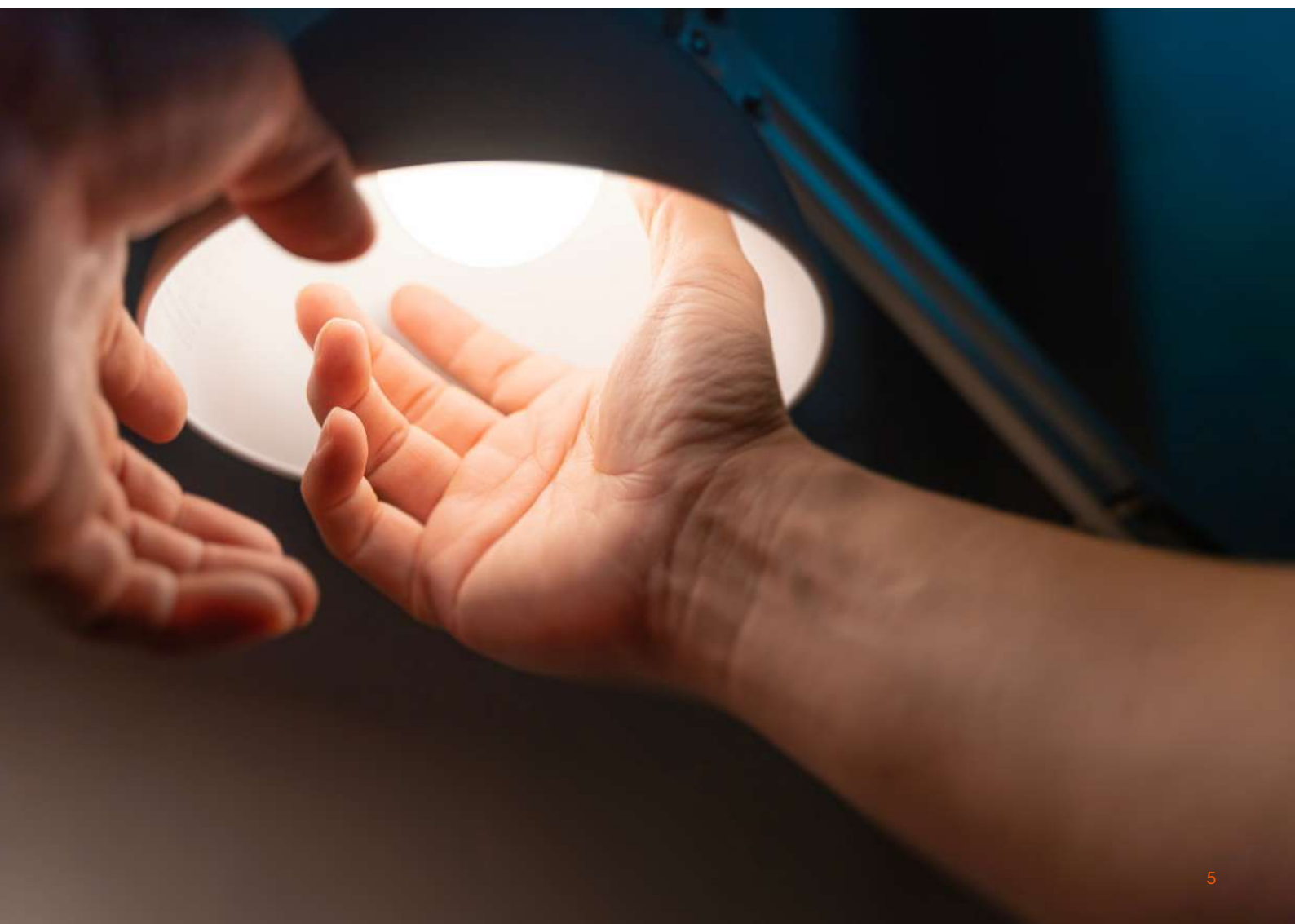

MACADAM ELLIPSE (SDCM), COLOUR RENDERING AND UGR

MACADAM ELLIPSE (SDCM)

When choosing your LED luminaire, an important factor to consider is the colour consistency. SDCM (Standard Deviation Colour Matching) rating, measures the colour consistency emitted by the light. The lower the rating the lower variation within the colour the human eye can see. For example, a fitting with SDCM<8 may emit 175K difference between two of the exact same fittings. Where as SDCM<1 would emit just a 30K difference. The standard rule of thumb is anything under SDCM<3 would not emit any colour inconsistencies to the naked eye.

COLOUR RENDERING

The Colour Rendering Index (CRI) of a lamp or fitting is a measurement of a light source’s ability to show object colour realistically or naturally. The higher the CRI rating, the true colour of an object will show as if under natural light. Applications such as retail display and grocery lighting should consider a high CRI to enhance the vividness of their goods. All indoor LEDVANCE luminaires have a minimum CRI of 80.

Poor Colour Rendering



True Colour Rendering



LOW Ra

MEDIUM Ra

HIGH Ra

Ra 60>

Ra 80>

Ra 90>

The images provided above are for simulation purposes only.

UNIFORM GLARE RATING (UGR)

UGR is the method of calculating the amount of glare emitted from artificial light to reduce visual discomfort which has a classification range from 5 up to 40. It is important to consider the amount of glare the fitting will produce when choosing luminaires to go in a working space such as an office. LED panels are practical and popular for commercial fit outs as they generally emit a UGR of 22 or less. Check out our vast array of LED panels including our new UGR19 panel for the ultimate visual comfort.

IP RATING & IK RATING

IP RATING

IP rating (Ingress Protection) is a very important factor to consider when selecting your LED lights. It is an international method which is used to define the protection of a fitting to prevent water damage and penetration of solid objects. The first unit rates solid objects and dust protection ranging from 1 to 6. The second is the liquid protection ranging from 1 to 8.

FIRST DIGIT

1	Protected against solid objects, greater than 50mm
2	Protection against solid objects, greater than 12.55
3	Protection against solid objects, greater than 2mm
4	Protection against solid objects, greater than 1mm
5	Protection against dust (limited dust permitted not interfering with performance of fitting)
6	Completely dust tight

IP 65
Ingress Protection

SECOND DIGIT

1	Protection against drops of water (vertical only). Limited ingress permitted.
2	Protection against falling drops of water (diagonally) with enclosures with a tilt of up to 15 degrees from vertical. Limited ingress permitted.
3	Protection against water falling (diagonally) up to 60 degrees>Limited ingress permitted
4	Protection against splashes of water from all directions. Limited ingress permitted
5	Protection against water spray from all directions. Limited ingress permitted
6	Protection again high pressure sprays in any direction. Limited ingress permitted.
7	Submersible under water for 30 minutes at 1m depth
8	Fully submersible for long periods of time at a depth of no more that 5m

IK RATING

IK Rating (Impact Protection) is an international method used to indicate the level of protection provided by enclosures for electrical equipment against external mechanical impacts. The higher the numeric figure indicates the level of impact the product can withstand.

IK CODE	IMPACT ENERGY (J)	EQUIVALENT IMPACT
IK00	(No Protection)	(No Test)
IK01	0.14	0.25kg mass dropped from 56mm above
IK02	0.2	0.25kg mass dropped from 80mm above
IK03	0.35	0.2kg mass dropped from 140mm above
IK04	0.5	0.25kg mass dropped from 200mm above
IK05	0.7	0.25kg mass dropped from 280mm above
IK06	1	0.25kg mass dropped from 400mm above
IK07	2	0.5kg mass dropped from 400mm above
IK08	5	1.7kg mass dropped from 300mm above
IK09	10	5kg mass dropped from 200mm above
IK10	20	5kg mass dropped from 400mm above

IC RATING

INSULATION CONTACT RATING (IC)

Insulation Contact (IC) governs whether a recessed luminaire can be safely operated when installed with potentially flammable materials. All insulation must maintain a minimum of 100mm clearance from the luminaire. Below table shows the recessed downlights classification types to help select your application requirements

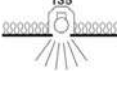
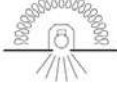
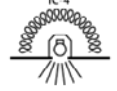
Type	Symbol	Description (AS/NZS 60598.2.2:2018)	Covered	Abutted	Use with insulation	Commercial	Residential
NON IC		A recessed luminaire that cannot be abutted against or covered by normally flammable materials or used in installations where building insulation or debris is, or may be, present in normal use	x	x	x	✓	x
DO NOT COVER		A recessed luminaire that can be abutted against normally flammable materials, including building insulation, are or may be present but cannot be abutted against any material and cannot be covered in normal use.	x	x	✓	✓	x
CA90		A recessed luminaire that can be abutted against normally flammable materials., Including building insulation, but cannot be covered in normal use. Building elements, building insulation or debris have limited access to the heated parts of the luminaire	✓	✓	✓	✓	x
CA135 (NZ)		A recessed luminaire that can be abutted against normally flammable materials, including building insulation, but cannot be covered in normal use. Building elements, building insulation or debris have limited access to the heated parts of the luminaire.	x	✓	✓	✓	✓
IC		A recessed luminaire that can be abutted against normally flammable materials, including building insulation, and can be covered in normal use. Building elements, building insulation or debris have limited access to the heated parts of the luminaire.	✓	✓	✓	✓	✓
IC-4		A recessed luminaire that can be abutted against normally flammable materials, including building insulation, and can be covered in normal use. Building elements, building insulation or debris have restricted access to the heated parts of the luminaire. This classification of recessed luminaire is effectively a sealed unit that has a restricted flow of air between the habitable room of the luminaire emits light into and the void/space where the main body of the luminaire is located.	✓	✓	✓	✓	✓

FLUOROCYCLE & EXITCYCLE

ABOUT FLUOROCYCLE



FluoroCycle

In Australia, over 90 percent of waste mercury-containing lamps currently end up in landfill each year. They are the largest single category of products that contain mercury, and their disposal contributes significantly to Australia's total annual emissions of mercury.

The focus of FluoroCycle is on the commercial and public lighting sectors, which account for approximately 90 per cent of all lighting waste. The scheme is intended to reduce the amount of mercury entering the environment from the disposal of waste mercury-containing lamps.

FluoroCycle is to reduce the amount of mercury entering the environment from waste mercury-containing lamps by continuously increasing the recycling of these lamps.

Some of the more common mercury-containing lamps are:

- Compact fluorescent lamps (CFLs) used mostly in homes and hotels and, under an Australian Standard, containing no more than 5 milligrams (mg) of mercury
- Linear fluorescent tubes used in most commercial and public buildings and, under an Australian Standard, contain less than 15 mg of mercury.
- High intensity discharge (HID) lamps, including mercury vapour lamps used for street lighting, containing from 12mg to 320mg of mercury.

ABOUT EXITCYCLE



In Australia, it is estimated that approximately 95 per cent of emergency and exit lighting batteries currently end up in landfill each year.

EXITCYCLE is to reduce the amount of cadmium and lead entering the environment from end-of-life emergency and exit lighting batteries by continuously increasing the recycling of these batteries.

Emergency and exit lighting batteries:

- It is estimated that 90% of batteries used in emergency lighting are nickel cadmium (Ni-Cd) with a small proportion of sealed lead acid (SLA) and nickel metal hydride (Ni-MH) batteries.
- Approximately 5 million nickel cadmium (Ni-Cd) batteries are sent to landfill each year which equates to approximately 90 tonnes of cadmium.
- Emergency lighting batteries are a priority for recycling because they are amongst the most hazardous of all batteries.
- Cadmium and lead are toxic heavy metals that need to be carefully managed to minimise their potential impacts on humans and the natural environment.
- Recycling ensures that these materials are safely recovered rather than disposed to landfill.

SAFETY AND PERFORMANCE

LEDVANCE PROMISE

All LED luminaires are equipped with high-quality LED modules in the highest energy efficiency classes (A, A+ and A++). Energy efficiency class (EEC) on a scale of A++ (highest efficiency) to E (lowest efficiency). The luminaires contain built-in LED modules. They cannot be changed in the luminaire.

All LEDVANCE luminaires are compliant with AS/NZS 60598 - Luminaires General requirements and tests.

PERFORMANCE

At LEDVANCE we offer only the highest quality chips and drivers to power your luminaires with a flicker free policy, ensuring you get the ultimate visual comfort from your lights.

JUST IN CASE: LED EMERGENCY LIGHTING FROM LEDVANCE

LEDVANCE also offer a versatile, ready-to-install emergency luminaires for your safety, in cases of emergency, lighting can provide orientation and help save lives. Standards and regulations for safety lighting can therefore be found nationally and internationally especially enshrined in occupational health and safety, accident prevention and building law. LED lighting provider LEDVANCE will present extremely versatile emergency luminaires for almost all areas of safety lighting. All LEDVANCE Emergency lighting is AS/NZS 2293, AS/NZS 60598 complaint.

THE REGULATORY COMPLIANCE MARK (RCM)

When shopping around for your LED lighting, ensure the RCM logo is clearly marked on the box packaging or on the actual luminaire.



This logo is a symbol which represent compliance within Australia with two independent schemes

- EESS and:
- ACMA

For more information on RCM, guidelines and equipments can be found in Australian Standards AS/NZS 4417.1 and AS/NZS 4417.2 Marking of electrical products to indicate compliance with regulations – General rules for use of the mark.



LEDVANCE
ADVANCING LIGHT

LEDVANCE

CLASSICS



DOWNLIGHT

Applications: Public areas | Shops | Stairways | Corridors | Foyers | Bathrooms | Kitchens



SUPERSTAR DOWNLIGHT

14



SUPERSTAR TRI COLOUR GIMBLE DOWNLIGHT

18



SUPERSTAR GIMBLE DOWNLIGHT

22



SUPERSTAR SLIM DOWNLIGHT

26



MODULAR DOWNLIGHT

30



COMMERCIAL DOWNLIGHT

36



SURFACE MOUNT DOWNLIGHT

40



ULTRA COMMERCIAL DOWNLIGHT

44

Superstar Downlight

The Superstar Downlight offers high output and efficiency whilst being compact and versatile, providing a seamless design ideal for use through the modern home.



FEATURES AND BENEFITS

- 6W, 7.5W, 9W, 11W
- Cut out size in 75mm, 90mm, 110mm, and 125mm
- Flat or step recess diffuser
- Tri colour in 3000K, 4000K, and 5000K
- High efficacy up to 100 lm/W
- Insulation contact rating IC-4
- Trailing edge universal dimmer compatible
- Beam angle 90°
- IP44
- Pre-wired with 1m flex and plug
- Polycarbonate housing
- Lifetime 30000 hours

AREAS OF APPLICATION

- Public spaces
- All residential areas including kitchens and bathrooms
- Reception areas and foyers
- Entrances and hallways
- Retail and hospitality

AVAILABLE SIZES



6W
Cut out: 72mm
Ø96x52.5mm



7.5W
Cut out: 90mm
Ø115x57.5mm



9W
Cut out: 110mm
Ø130x57.5mm



11W
Cut out: 125mm
Ø150x62.5mm

AVAILABLE DESIGN



Flat diffuser



Step recess diffuser

SPECIFICATIONS

Wattage	6W, 7.5W, 9W, 11W	Connection Type	1m flex and plug
Lumens	600, 750, 900, 1100	Driver Technology	Integral
lm/W	100	Voltage	220-240V
CCT	3000/4000/5000K	PF	>0.7
IC Rating	IC-4	Frequency	50/60Hz
IP Rating	IP44(Front)/IP20(Back)	Mounting Type	Recessed mounting
Dimmable	Trailing edge	Operating Temperature	-20°C to 40°C
Housing Material	Polycarbonate	Lifetime	30000 hours
Beam Angle	100°	Warranty	5 years
CRI	>80		
SDCM	<6		
Electrical Classification	Class II		

PHOTOMETRICS

(Example of LDVSSDL7.5W840)

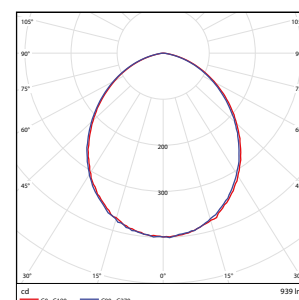

DIMENSIONS

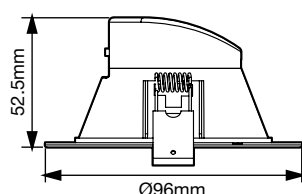

Cut out: 72mm
Ø96mmx52.5mm

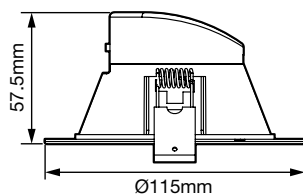

Cut out: 90mm
Ø115mmx57.5mm

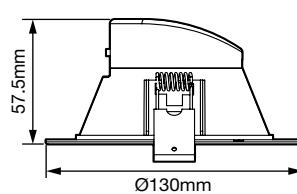

Cut out: 110mm
Ø130mmx57.5mm

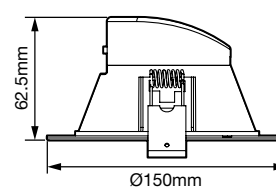

Cut out: 125mm
Ø150mmx62.5mm

ORDERING CODES - SUPERSTAR DOWNLIGHT



Product name	EAN10	Model number	W	lm	K	°	lm/W	CUT OUT (mm)	1	L (mm)	w (mm)	h (mm)	g
--------------	-------	--------------	---	----	---	---	------	--------------	---	--------	--------	--------	---

FLAT

LDVAL DL SS 6W 75MM TRI G5 12X1 AU LEDV	4058075706194	LDVSSDL6WTRI	6	600	3000/ 4000/ 5000	100	100	72	✓	96	96	52.5	170
LDVAL DL SS 7.5W 90MM TRI G5 12X1AU LEDV	4058075706217	LDVSSDL7.5WTRI	7.5	750	3000/ 4000/ 5000	100	100	90	✓	115	115	57.5	200
LDVAL DL SS 9W 110MM TRI G5 12X1 AU LEDV	4058075706255	LDVSSDL9WTRI	9	900	3000/ 4000/ 5000	100	100	110	✓	130	130	57.5	225
LDVAL DL SS 11W 125MM TRI G5 12X1AU LEDV	4058075706279	LDVSSDL11WTRI	11	1100	3000/ 4000/ 5000	100	100	125	✓	150	150	62.5	310

STEP RECESS

LDVAL DL SS R 7.5W 90MM TRIG512X1AU LEDV	4058075706231	LDVSSDLR7.5WTRI	7.5	750	3000/ 4000/ 5000	100	100	90	✓	115	115	57.5	200
--	----------------------	-----------------	-----	-----	------------------------	-----	-----	----	---	-----	-----	------	-----

1 Brightness can be adjusted using a compatible dimmer. See below table for applicative dimmer.

Dimmer brand	Dimming mode	Pin-Min	Pin-Max	THD@Max	Io-Min	Io-Max	Typical	Dimming range
7.5W MODEL								
LUMEX-LT1D450LS	REVERSE-PHASE	0.73	7.91	139.39	4.5	127	127	1.65% 100.0%
CLIPSAL-32E450UDM	BOTH	0.93	7.79	146.9	14.7	127	127	10.87% 99.7%
HPM-CAT400T HPM	REVERSE-PHASE	1.65	7.85	107.12	8.4	125.1	127	5.67% 98.3%
CLIPSAL-32ELEDM	REVERSE-PHASE	0.48	7.31	169.8	3.9	127	127	1.97% 100.0%
CLIPSAL-32E450LM	FORWARD-PHASE	0.09	7.53	346.45	0	127	127	0.00% 94.1%
HPM-CAT400L	FORWARD-PHASE	0.88	6.95	194.73	14.3	116.8	127	9.84% 92.3%
SAL-SDA450	REVERSE-PHASE	2.76	8.12	82.93	32.7	127	127	21.42% 100.0%
DIGINET-MMDM/PB	REVERSE-PHASE	0.60	8.08	153.76	0.9	127	127	0.00% 100.0%



SUPERSTAR DOWNLIGHT

Superstar Tri Colour Gimble Downlight

The Superstar Tri Colour Gimble Downlight is ideal for creating a dynamic lighting scheme. Modern design downlight in white with easy plug and play for a quick installation.



FEATURES AND BENEFITS

- 5W, 7W
- Cut out size in 70mm and 90mm
- Tri colour in 3000K, 4000K and 5700K
- Trailing edge universal dimmer compatible
- Beam angle 60°
- IP54
- Pre-wired with 1.2m flex and plug
- Polycarbonate housing
- Lifetime 50000 hours

AREAS OF APPLICATION

- Public spaces
- Dry residential such as bedrooms and living areas.
- Reception areas and foyers
- Entrances and hallways
- Retail and hospitality

AVAILABLE SIZES



5W
Cut out: 70mm
Ø85x55mm



7W
Cut out: 90mm
Ø105x55mm

AVAILABLE DESIGN



White



Black

SPECIFICATIONS

Wattage	5W, 7W	Connection Type	1.2m flex and plug
Lumens	570, 800	Driver Technology	Integral
lm/W	115	Voltage	220-240V
CCT	3000K/4000K/5700K	PF	>0.8
IC Rating	IC-4	Frequency	50/60Hz
IP Rating	IP54(Front)/IP20(Back)	Mounting Type	Recessed mounting
Dimmable	Yes	Operating Temperature	-20°C to 40°C
Housing Material	Polycarbonate	Lifetime	50000 hours
Beam Angle	60°	Warranty	5 years
CRI	>80		
SDCM	<6		
Electrical Classification	Class II		

PHOTOMETRICS

(Example of LDVDLGIM5WTRI)

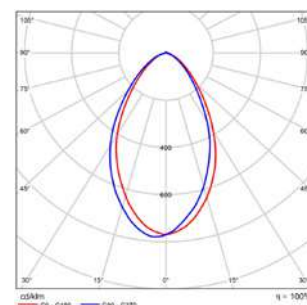

DIMENSIONS

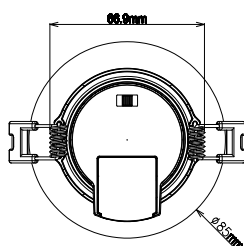

5W
Cut out: 70mm
Ø85x55mm

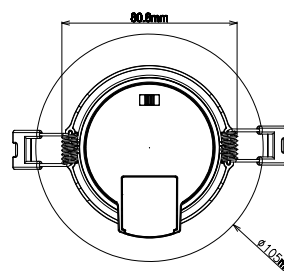

7W
Cut out: 90mm
Ø105x55mm

ORDERING CODES - SUPERSTAR TRI COLOUR GIMBLE DOWNLIGHT



Product name	EAN10	Model number	W	lm	K	°	lm/w	CUT OUT [mm]	1	∅ d [mm]	h [mm]	g
--------------	-------	--------------	---	----	---	---	------	--------------	---	----------	--------	---

WHITE

LDVAL DL GIM 5W 70MM TRI 16X1 AU LEDV	4099854315442	LDVDLGIM5WTRI	5	500/ 570/ 520	3000/ 4000/ 5700	60	100/ 115/ 105	70	✓	85	55	186
LDVAL DL GIM 7W 90MM TRI 16X1 AU LEDV	4099854315466	LDVDLGIM7WTRI	7	700/ 800/ 730	3000/ 4000/ 5700	60	100/ 115/ 105	90	✓	105	55	223

BLACK

LDVAL DL GIM 5W 70MM BK TRI 16X1 AU LEDV	4099854315480	LDVDLGIM5WTRIBK	5	450/ 510/ 470	3000/ 4000/ 5700	60	90/ 103/ 94	70	✓	85	55	186
LDVAL DL GIM 7W 90MM BK TRI 16X1 AU LEDV	4099854315503	LDVDLGIM7WTRIBK	7	630/ 720/ 650	3000/ 4000/ 5700	60	90/ 103/ 94	90	✓	105	55	223

1 Brightness can be adjusted using a compatible dimmer. See below table for applicative dimmer.

Dimmer brand	Dimming mode	Io-Min	Io-Max	Dimming range		Io-Min	Io-Max	Dimming range	
				5W	7W			5W	7W
LEDVANCE LDVDIMMERUNIV	UNIVERSAL	5.5	68.5	7.91%	97.86%	5.7	66.2	8.51%	98.81%
CLIPSAL 32E450TM	TRAILING EDGE	20.0	68.7	28.78%	99.08%	19.0	64.8	29.04%	98.90%
CLIPSAL 32E450UDM	UNIVERSAL	27.9	68.7	18.57%	99.03%	25.7	65.0	17.11%	99.28%
CLIPSAL 32E450LM	LEADING EDGE	14.2	68.2	9.47%	98.43%	19.5	64.2	29.79%	97.98%
SHYUSC-AU- RDMS350VA	TRAILING EDGE	6.7	68.6	9.68%	98.95%	2.4	64.7	3.70%	98.81%
DIGINET MEDM/DGRT	TRAILING EDGE	3.4	68.7	4.89%	99.08%	0.5	64.6	0.81%	98.64%
DIGINET MEDM 2-400W	TRAILING EDGE	0.3	68.5	0.38%	98.76%	0.1	64.5	0.09%	98.43%
DETA-MODEL 6030/4-150W	TRAILING EDGE	33.7	68.4	48.07%	97.71%	30.0	65.0	46.15%	100.00%
PDL-654M 20- 450VA	TRAILING EDGE	25.9	68.8	37.31%	99.21%	24.2	65.1	36.92%	99.37%
CABAC D42233	TRAILING EDGE	0.0	68.1	0.01%	97.29%	0.0	65.0	0.02%	100.00%
SDA450U	TRAILING EDGE	13.9	68.4	19.86%	97.71%	12.3	65.0	18.88%	100.00%
SDD350UM	TRAILING EDGE	6.4	68.2	9.14%	97.43%	12.3	65.0	18.88%	100.00%
31E2PUPM	TRAILING EDGE	19.1	68.4	27.60%	98.73%	21.8	64.6	33.23%	98.63%
TRADER-DIMR- 400W	TRAILING EDGE	30.1	68.7	43.36%	99.05%	27.6	64.9	42.20%	99.08%
TRADER-DIMPR- 400W	TRAILING EDGE	0.0	68.6	0.00%	98.99%	0.1	64.7	0.11%	98.76%



SUPERSTAR TRI COLOUR GIMBLE DOWNLIGHT

Superstar Gimble Downlight

The Superstar Gimble Downlight is ideal for creating a dynamic lighting scheme. Modern design downlight in white with easy plug and play for a quick installation.



FEATURES AND BENEFITS

- 7W, 10W
- Cut out size in 70mm and 92mm
- Single colour in 3000K and 4000K
- Dimmable
- Beam angles 60°
- IP40
- Pre-wired with 1.2m flex and plug
- Polycarbonate housing
- Lifetime 30000 hours

AREAS OF APPLICATION

- Public spaces
- Dry residential such as bedrooms and living areas.
- Reception areas and foyers
- Entrances and hallways
- Retail and hospitality

AVAILABLE SIZES



7W
Cut out: 70mm
Ø85x64.5mm



10W
Cut out: 92mm
Ø105x71.5mm

SPECIFICATIONS

Wattage	7W, 10W	Connection Type	1.2m flex and plug
Lumens	630, 920	Driver Technology	Integral
lm/W	90	Voltage	220-240V
CCT	3000K, 4000K	PF	>0.9
IC Rating	IC-4	Frequency	50/60Hz
IP Rating	IP40	Mounting Type	Recessed mounting
Dimmable	Yes	Operating Temperature	-20°C to 45°C
Housing Material	Polycarbonate	Lifetime	30000 hours
Beam Angle	60°	Warranty	5 years
CRI	>80		
SDCM	<6		
Electrical Classification	Class II		

PHOTOMETRICS

(Example of LDVDLGIM10W840G2)

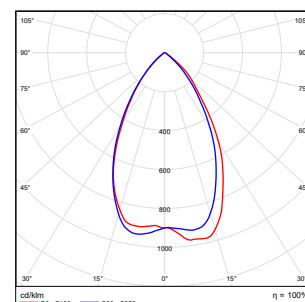

DIMENSIONS

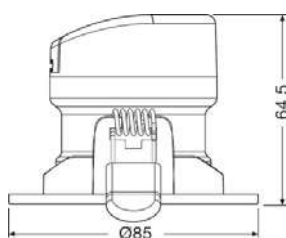

7W
Cut out: 70mm
Ø85x64.5mm

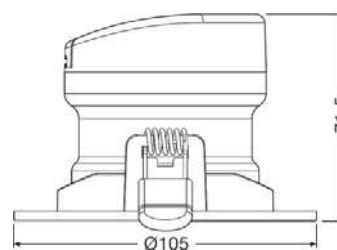

10W
Cut out: 92mm
Ø105x71.5mm

ORDERING CODES - SUPERSTAR GIMBLE DOWNLIGHT



Product name	EAN10	Model number	W	lm	K	°	lm/W	CUT OUT [mm]	✓	L [mm]	W [mm]	h [mm]	9
---------------------	--------------	---------------------	----------	-----------	----------	----------	-------------	---------------------	----------	---------------	---------------	---------------	----------

SUPERSTAR GIMBLE DOWNLIGHT

SUPERSTAR GIMBLE DOWNLIGHT

LDPFM DL 70MM GIM 7W 830 30X1 AU LEDV	4058075132399	LDVDLGIM7W830G2	7	630	3000	60	90	70	✓	85	85	64.5	220
LDPFM DL 70MM GIM 7W 840 30X1 AU LEDV	4058075132436	LDVDLGIM7W840G2	7	630	4000	60	90	70	✓	85	85	64.5	220
LDPFM DL 70MM GIM 7W 840 30X1 AU LEDV	4058075132375	LDVDLGIM10W830G2	10	920	3000	60	90	92	✓	105	105	71.5	280
LDPFM DL 90MM GIM 10W 840 24X1 AU LEDV	4058075132412	LDVDLGIM10W840G2	10	920	4000	60	90	92	✓	105	105	71.5	280

1 Brightness can be adjusted using a compatible dimmer. See below table for applicative dimmer.

Dimmer brand	Dimming mode	Input			Output	
		Pin-Min	Pin-Max	THD@Max	Io-Min	Io-Max
CLIPSAL LEADING EDGE	LEADING EDGE	1.12	9.07	50.50	2	99
CLIPSAL TRAILING EDGE	TRAILING EDGE	1.66	8.90	19.60	8	101
CLIPSAL UNIVERSAL	UNIVERSAL	2.03	8.97	45.10	13	102
HPM LEADING EDGE	LEADING EDGE	1.65	8.05	73.30	0	84
HPM TRAILING EDGE	TRAILING EDGE	1.46	8.23	54.10	4	93



SUPERSTAR GIMBLE DOWNLIGHT

Superstar Slim Downlight

The Superstar Slim Downlight is the perfect lighting solution for your modern home. With its sleek and slim design, it blends seamlessly into any space, providing a subtle yet effective illumination. Featuring a remote driver, you can easily control the brightness and colour temperature of the light, making it ideal for any occasion.



FEATURES AND BENEFITS

- 8W
- Cut out size 90mm
- Tri colour in 3000K, 4000K and 5700K
- High efficacy up to 110lm/W
- Dimmable
- Beam angle 100°
- IP54
- Pre-wired with flex and plug
- Polycarbonate housing
- Lifetime 50000 hours

AREAS OF APPLICATION

- Public spaces
- Dry residential such as bedrooms and living areas.
- Reception areas and foyers
- Entrances and hallways
- Retail and hospitality

AVAILABLE SIZES



8W
Cut out: 90mm
Ø100x30mm

SPECIFICATIONS

Wattage	8W	Connection Type	1.3m flex and plug
Lumens	890	Driver Technology	Remote
lm/W	110	Voltage	220-240V
CCT	3000K/4000K/5700K	PF	>0.9
IC Rating	IC-4	Frequency	50/60Hz
IP Rating	IP54(Front)/IP20(Back)	Mounting Type	Recessed mounting
Dimmable	Yes	Operating Temperature	-20°C to 40°C
Housing Material	Polycarbonate	Lifetime	50000 hours
Beam Angle	100°	Warranty	5 years
CRI	>80		
SDCM	<6		
Electrical Classification	Class II		

PHOTOMETRICS

(Example of LDVDLSLIM8WTRI)

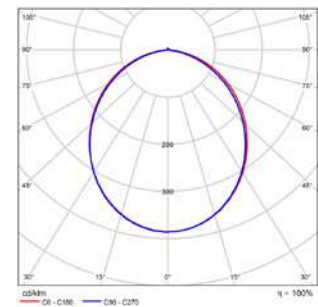

DIMENSIONS

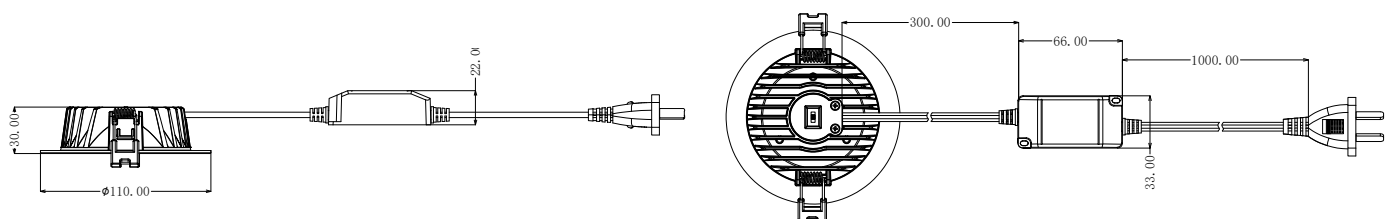

8W
Cut out: 90mm
Ø100x30mm

ORDERING CODES - SUPERSTAR SLIM DOWNLIGHT

PERFORMANCE CLASS



Product name	EAN10	Model number	W	lm	K		lm/w	CUT OUT [mm]	¹			
--------------	-------	--------------	---	----	---	--	------	--------------	--------------	--	--	--

SUPERSTAR SLIM DOWNLIGHT

LDVAL DL SLIM 8W 90MM TRI 36X1 AU LEDV	4099854220555	LDVDLSLIM8WTRI	8	890	3000/ 4000/ 5700	100	110	90	✓	100	30	200
--	---------------	----------------	---	-----	------------------------	-----	-----	----	---	-----	----	-----

¹ Brightness can be adjusted using a compatible dimmer. See below table for applicative dimmer.

Dimmer brand	Dimming mode	Io-Min	Io-Max	Dimming range	
LDVDLSLIM8WTRI					
LEDVANCE LDVDIMMERUNIV	UNIVERSAL	6.2	110.1	5.39%	95.74%
CLIPSAL LEADING EDGE	LEADING EDGE	0.0	113.3	0.02%	99.04%
CLIPSAL 32E450TM	TRAILING EDGE	18.7	114.1	16.36%	99.74%
CLIPSAL 32E450UDM	UNIVERSAL	26.1	115.5	17.40%	100.96%
CLIPSAL 32E450LM	LEADING EDGE	7.3	109.6	6.38%	95.80%
HPM CAT 400T	TRAILING EDGE	11.6	96.2	10.17%	84.09%
HPM 200L 10- 200W	LEADING EDGE	5.02	115	4.39%	100.52%
SHYUSC-AU- RDMS350VA	TRAILING EDGE	5.9	108.8	5.17%	95.10%
DIGINET MEDM/DGRT	TRAILING EDGE	0.6	113.9	0.55%	99.56%
DIGINET MEDM 2-400W	TRAILING EDGE	0.0	115.4	0.01%	100.87%
DETA-MODEL 6030/4-150W	TRAILING EDGE	39.2	106.0	34.27%	92.66%
PDL-654M 20- 450VA	TRAILING EDGE	23.6	115.5	20.63%	100.96%
CABAC D42233	TRAILING EDGE	0.0	108.1	0.01%	94.49%
SDA450U	TRAILING EDGE	14.9	114.5	13.02%	100.09%
SDD350UM	TRAILING EDGE	6.9	106.5	6.02%	93.09%
31E2PUPM	TRAILING EDGE	17.8	106.7	15.54%	93.27%
TRADER-DIMR- 400W	TRAILING EDGE	20.7	109.8	18.11%	95.98%
TRADER-DIMPR- 400W	TRAILING EDGE	0.0	109.4	0.02%	95.63%
SHYUSC-AU- PBD350VA	TRAILING EDGE	1.9	112.2	1.68%	98.08%
CABAC HNS610DT	TRAILING EDGE	27.0	105.4	23.62%	92.13%



SUPERSTAR SLIM DOWNLIGHT

Modular Downlight

An architectural style downlight with both dichroic and reflector lens options to mimic the look and feel of traditional halogen downlight can be paired with one of the many interchangeable trims.



FEATURES AND BENEFITS

- 10W, 13W, 18W
- Available in dichroic or reflector lenses with 18 different trims
- Single colour in 2700K, 3000K, and 4000K
- High efficacy up to 90 lm/W
- Dimmable with fast connector for easy driver switch
- Beam angle 36° or 60°
- IP20
- Pre-wired with 1.2m flex and plug
- Aluminum housing
- Lifetime 50000 hours

AREAS OF APPLICATION

- Public spaces
- Dry residential such as bedrooms and living areas.
- Reception areas and foyers
- Entrances and hallways
- Retail and hospitality

AVAILABLE SIZES

STEP 1. CHOOSE YOUR MODULE



10W, 13W, 18W
Dichroic lens
Lens material
PMMA



10W, 13W, 18W
Reflector
Lens material
Aluminium

STEP 2. CHOOSE YOUR TRIM (SOLD SEPARATELY)



Oval
LDVDLMODAOH80
Cut out: 75-80mm



Circular
LDVDLMODACH80
Cut out: 75-80mm



Deep Recess
LDVDLMODADR80
Cut out: 75-80mm



Adjustable
LDVDLMODAG80
Cut out: 75-80mm



Square Deep Recess
LDVDLMODASDR95
Cut out: 90-95mm



Deep Recess
LDVDLMODADR95
Cut out: 90-95mm



Adjustable
LDVDLMODAG95
Cut out: 90-95mm



Asymmetrical LD-
VDL
LDVDMODAA95
Cut out: 90-95mm



Square Adjustable
LDVDLMODASG95
Cut out: 90-95mm

SPECIFICATIONS

Wattage	10W, 13W, 18W
Lumens	830, 1079, 1494
lm/W	90
CCT	2700K, 3000K, 4000K
IP Rating	IP20
Dimmable	Trailing edge
Housing Material	Aluminium
Beam Angle	36°, 60°
CRI	>90
SDCM	<5
Electrical Classification	Class II

Connection Type	1.2m flex and plug
Driver Technology	Remote
Voltage	220-240V
PF	>0.9
Frequency	50/60Hz
Mounting Type	Recessed mounting
Operating Temperature	-20°C to 40°C
Lifetime	50000 hours
Warranty	5 years

PHOTOMETRICS

(Example of LDVDLMODR10W92760D)

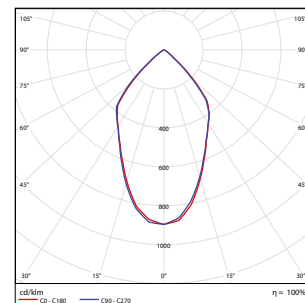

(Example of LDVDLMODDI10W92736D)

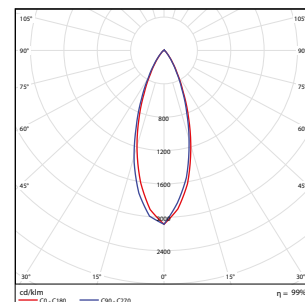

DIMENSIONS

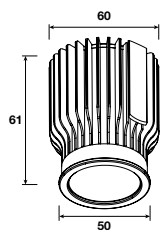

10W, 13W
Ø60x61mm

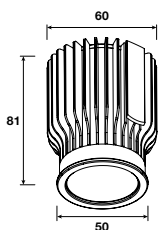

18W
Ø60x81mm

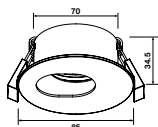

Oval
LDVDLMODAOH80
Cut out: 75-80mm

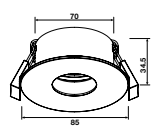

Circular
LDVDLMODACH80
Cut out: 75-80mm

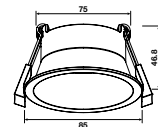

Deep Recess
LDVDLMODADR80
Cut out: 75-80mm

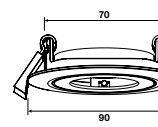

Adjustable
LDVDLMODAG80
Cut out: 75-80mm

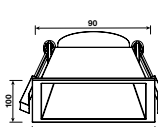

Square Deep Recess
LDVDLMODASDR95
Cut out: 90-95mm

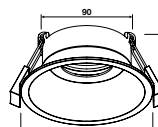

Deep Recess
LDVDLMODADR95
Cut out: 90-95mm

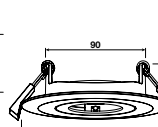

Adjustable
LDVDLMODAG95
Cut out: 90-95mm

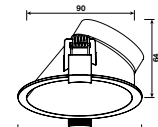

Asymmetrical LD-
VDL
LDVDMODAA95
Cut out: 90-95mm

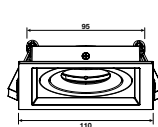

Square Adjustable
LDVDLMODASG95
Cut out: 90-95mm

ORDERING CODES - MODULAR DOWNLIGHT

PERFORMANCE CLASS



Product name	EAN10	Model number	W	lm	K		lm/w						
--------------	-------	--------------	---	----	---	--	------	--	--	--	--	--	--

DICHROIC 36°

LDPFM DL MOD DI 10W 927 36D 50X1 AU LEDV	4058075388444	LDVLMODDI10W92736D	10	730	2700	36	73	✓	50	50	61	220
LDPFM DL MOD DI 10W 930 36D 50X1 AU LEDV	4058075388468	LDVLMODDI10W93036D	10	730	3000	36	73	✓	50	50	61	220
LDPFM DL MOD DI 10W 940 36D 50X1 AU LEDV	4058075388482	LDVLMODDI10W94036D	10	830	4000	36	83	✓	50	50	61	220
LDPFM DL MOD DI 13W 927 36D 50X1 AU LEDV	4058075388505	LDVLMODDI13W92736D	13	949	2700	36	73	✓	50	50	61	220
LDPFM DL MOD DI 13W 930 36D 50X1 AU LEDV	4058075388529	LDVLMODDI13W93036D	13	949	3000	36	73	✓	50	50	61	220
LDPFM DL MOD DI 13W 940 36D 50X1 AU LEDV	4058075388543	LDVLMODDI13W94036D	13	1079	4000	36	83	✓	50	50	61	220
LDPFM DL MOD DI 18W 927 36D 36X1 AU LEDV	4058075388567	LDVLMODDI18W92736D	18	1314	2700	36	73	✓	50	50	81	250
LDPFM DL MOD DI 18W 930 36D 36X1 AU LEDV	4058075388581	LDVLMODDI18W93036D	18	1314	3000	36	73	✓	50	50	81	250
LDPFM DL MOD DI 18W 940 36D 36X1 AU LEDV	4058075388604	LDVLMODDI18W94036D	18	1494	4000	36	83	✓	50	50	81	250

DICHROIC 60°

LDPFM DL MOD DI 10W 927 60D 50X1 AU LEDV	4058075388628	LDVLMODDI10W92760D	10	730	2700	60	73	✓	50	50	61	220
LDPFM DL MOD DI 10W 930 60D 50X1 AU LEDV	4058075388642	LDVLMODDI10W93060D	10	730	3000	60	73	✓	50	50	61	220
LDPFM DL MOD DI 10W 940 60D 50X1 AU LEDV	4058075388666	LDVLMODDI10W94060D	10	830	4000	60	83	✓	50	50	61	220
LDPFM DL MOD DI 13W 927 60D 50X1 AU LEDV	4058075388680	LDVLMODDI13W92760D	13	949	2700	60	73	✓	50	50	61	220
LDPFM DL MOD DI 13W 930 60D 50X1 AU LEDV	4058075388703	LDVLMODDI13W93060D	13	949	3000	60	73	✓	50	50	61	220
LDPFM DL MOD DI 13W 940 60D 50X1 AU LEDV	4058075388727	LDVLMODDI13W94060D	13	1079	4000	60	83	✓	50	50	61	220
LDPFM DL MOD DI 18W 927 60D 36X1 AU LEDV	4058075388741	LDVLMODDI18W92760D	18	1314	2700	60	73	✓	50	50	81	250
LDPFM DL MOD DI 18W 930 60D 36X1 AU LEDV	4058075388765	LDVLMODDI18W93060D	18	1314	3000	60	73	✓	50	50	81	250
LDPFM DL MOD DI 18W 940 60D 36X1 AU LEDV	4058075388789	LDVLMODDI18W94060D	18	1494	4000	60	83	✓	50	50	81	250

ORDERING CODES - MODULAR DOWNLIGHT

PERFORMANCE CLASS



Product name	EAN10	Model number	W	lm	K		lm/w					
--------------	-------	--------------	---	----	---	--	------	--	--	--	--	--

REFLECTOR 36°







LDPFM DL MOD R 10W 927 36D 50X1 AU LEDV	4058075389021	LDVDLMDR10W92736D	10	730	2700	36	73	✓	50	50	61	220
LDPFM DL MOD R 10W 930 36D 50X1 AU LEDV	4058075389045	LDVDLMDR10W93036D	10	730	3000	36	73	✓	50	50	61	220
LDPFM DL MOD R 10W 940 36D 50X1 AU LEDV	4058075389069	LDVDLMDR10W94036D	10	830	4000	36	83	✓	50	50	61	220
LDPFM DL MOD R 13W 927 36D 50X1 AU LEDV	4058075389083	LDVDLMDR13W92736D	13	949	2700	36	73	✓	50	50	61	220
LDPFM DL MOD R 13W 930 36D 50X1 AU LEDV	4058075389106	LDVDLMDR13W93036D	13	949	3000	36	73	✓	50	50	61	220
LDPFM DL MOD R 13W 940 36D 50X1 AU LEDV	4058075389120	LDVDLMDR13W94036D	13	1079	4000	36	83	✓	50	50	61	220
LDPFM DL MOD R 18W 927 36D 36X1 AU LEDV	4058075389144	LDVDLMDR18W92736D	18	1314	2700	36	73	✓	50	50	81	250
LDPFM DL MOD R 18W 930 36D 36X1 AU LEDV	4058075389168	LDVDLMDR18W93036D	18	1314	3000	36	73	✓	50	50	81	250
LDPFM DL MOD R 18W 940 36D 36X1 AU LEDV	4058075389182	LDVDLMDR18W94036D	18	1494	4000	36	83	✓	50	50	81	250

REFLECTOR 60°

LDPFM DL MOD R 10W 927 60D 50X1 AU LEDV	4058075389205	LDVDLMDR10W92760D	10	730	2700	60	73	✓	50	50	61	220
LDPFM DL MOD R 10W 930 60D 50X1 AU LEDV	4058075389229	LDVDLMDR10W93060D	10	730	3000	60	73	✓	50	50	61	220
LDPFM DL MOD R 10W 940 60D 50X1 AU LEDV	4058075389243	LDVDLMDR10W94060D	10	830	4000	60	83	✓	50	50	61	220
LDPFM DL MOD R 13W 927 60D 50X1 AU LEDV	4058075389267	LDVDLMDR13W92760D	13	949	2700	60	73	✓	50	50	61	220
LDPFM DL MOD R 13W 930 60D 50X1 AU LEDV	4058075389281	LDVDLMDR13W93060D	13	949	3000	60	73	✓	50	50	61	220
LDPFM DL MOD R 13W 940 60D 50X1 AU LEDV	4058075389304	LDVDLMDR13W94060D	13	1079	4000	60	83	✓	50	50	61	220
LDPFM DL MOD R 18W 927 60D 36X1 AU LEDV	4058075389328	LDVDLMDR18W92760D	18	1314	2700	60	73	✓	50	50	81	250
LDPFM DL MOD R 18W 930 60D 36X1 AU LEDV	4058075389342	LDVDLMDR18W93060D	18	1314	3000	60	73	✓	50	50	81	250
LDPFM DL MOD R 18W 940 60D 36X1 AU LEDV	4058075389366	LDVDLMDR18W94060D	18	1494	4000	60	83	✓	50	50	81	250

ORDERING CODES - MODULAR DOWNLIGHT

LEDVANCE
5 year
guarantee

Product name	EAN10	Model number	CUT OUT (mm)	l (mm)	w (mm)	h (mm)			COLOUR
DEEP RECESS TRIM									
									
LDPFM A DR 80 100X1 AU LEDV	4058075389625	LDVDLMODADR80	75-80	85	85	46.8	95		WHITE
LDPFM A DR 80 BK 100X1 AU LEDV	4058075391543	LDVDLMODADR80BK	75-80	85	85	46.8	95		BLACK
OVAL TRIM									
									
LDPFM A OH 80 100X1 AU LEDV	4058075389649	LDVDLMODAOH80	75-80	85	85	34.5	130		WHITE
LDPFM A OH 80 BK 100X1 AU LEDV	4058075391567	LDVDLMODAOH80BK	75-80	85	85	34.5	130		BLACK
CIRCULAR TRIM									
									
LDPFM A CH 80 100X1 AU LEDV	4058075389663	LDVDLMODACH80	75-80	85	85	34.5	130		WHITE
LDPFM A CH 80 BK 100X1 AU LEDV	4058075391581	LDVDLMODACH80BK	75-80	85	85	34.5	130		BLACK
ADJUSTABLE TRIM									
									
LDPFM A G 80 100X1 AU LEDV	4058075389687	LDVDLMODAG80	75-80	90	90	24.8	90		WHITE
LDPFM A G 80 BK 100X1 AU LEDV	4058075391604	LDVDLMODAG80BK	75-80	90	90	24.8	90		BLACK
DEEP RECESS TRIM									
									
LDPFM A DR 95 100X1 AU LEDV	4058075389700	LDVDLMODADR95	90-95	100	100	45.8	120		WHITE
LDPFM A DR 95 BK 100X1 AU LEDV	4058075391628	LDVDLMODADR95BK	90-95	100	100	45.8	120		BLACK
ASYMMETRICAL TRIM									
									
LDPFM A A 95 100X1 AU LEDV	4058075389724	LDVDLMODAA95	90-95	100	100	64	99		WHITE
LDPFM A A 95 BK 100X1 AU LEDV	4058075391642	LDVDLMODAA95BK	90-95	100	100	64	99		BLACK

ORDERING CODES - MODULAR DOWNLIGHT

LEDVANCE
5 year
guarantee

Product name	EAN10	Model number	CUT OUT (mm)	l (mm)	w (mm)	h (mm)	COLOUR
--------------	-------	--------------	--------------	--------	--------	--------	--------

ADJUSTABLE TRIM



LDPFM A G 95 100X1 AU LEDV	4058075389748	LDVDLMODAG95	90-95	110	110	32	135	WHITE
LDPFM A G 95 BK 100X1 AU LEDV	4058075391666	LDVDLMODAG95BK	90-95	110	110	32	135	BLACK

SQUARE DEEP RECESS TRIM



LDPFM A SDR 95 50X1 AU LEDV	4058075389762	LDVDLMODASDR95	90-95	100	100	50	157	WHITE
LDPFM A SDR 95 BK 50X1 AU LEDV	4058075391680	LDVDLMODASDR95BK	90-95	100	100	50	157	BLACK

SQUARE ADJUSTABLE TRIM



LDPFM A SG 95 50X1 AU LEDV	4058075389786	LDVDLMODASG95	90-95	100	100	35	203	WHITE
LDPFM A SG 95 BK 50X1 AU LEDV	4058075391703	LDVDLMODASG95BK	90-95	110	110	35	203	BLACK

1 Brightness can be adjusted using a compatible dimmer. See below table for applicative dimmer.

Dimmer brand	Dim mode	Pin-Min	Pin-Max	THD@Max	Io-Min	Io-Max	Typical	Dimming range
CLIPSAL FRONT	FORWARD-PHASE	3.61	19.75	198	43.6	460	461	9.48% 99.78%
CLIPSAL32E450TM	REVERSE-PHASE	1.6	19.57	100	20.3	463	461	4.38% 100.43%
CLIPSAL32E450UDM	BOTH	1.98	19.55	91	29.5	463	461	6.37% 100.43%
HPM CAT 400T	REVERSE-PHASE	1.51	17.24	115	14.5	408.5	461	3.55% 88.61%
CLIPSAL32E450LM	FORWARD-PHASE	3.5	19.8	200	42.2	459	461	9.19% 99.57%
SHYUSC-AU-RDMS350VA	REVERSE-PHASE	0.82	18.5	117	6.2	434	461	1.43% 94.14%
SHYUSC-AU-RD350VA	REVERSE-PHASE	1.2	17.6	103	12	416	461	2.88% 90.24%
TRADER-DIMR-400W	REVERSE-PHASE	1.5	19.7	120	4	461	461	0.87% 100.00%
TRADER-DIMPR-400W	REVERSE-PHASE	1.15	19.9	143	9	463	461	1.94% 100.43%
HPM 200L 10-200W	FORWARD-PHASE	3.3	19.2	230	35	430	461	8.14% 93.28%
DETA-MODEI 6030/4-150W	REVERSE-PHASE	1.5	19.7	126	12.75	463	461	2.75% 100.43%
SHYUSC-AU-PBD350VA	REVERSE-PHASE	0.87	19.4	112	5.6	461	461	1.21% 100.00%
PDL-654M 20-450VA	REVERSE-PHASE	1.92	19.88	92.4	27.5	461	461	5.97% 100.00%
DIGINET MEDM 2-400W	REVERSE-PHASE	0.67	19.6	197	1	463	461	0.22% 100.43%

Commercial Downlight

Commercial Downlight is a reliable and high efficacy LED recessed downlight with aluminium housing for general purpose applications. The long lifetime enables substantial energy and maintenance savings.



FEATURES AND BENEFITS

- 18W, 25W, 35W, 45W
- Cut out size in 120mm, 140mm, 200mm and 230mm
- Tri colour in 3000K, 4000K, and 5700K
- High efficacy up to 100 lm/W
- Dimmable
- Beam angle 100°
- IP54
- Pre-wired with flex and plug
- Aluminium housing
- Lifetime 50000 hours

AREAS OF APPLICATION

- Public spaces
- Reception areas and foyers
- Entrances and hallways
- Retail and hospitality
- Commercial buildings and lobbies

AVAILABLE SIZES



18W
Cut out: 120-130mm
Ø145x45mm



25W
Cut out: 140-150mm
Ø170x45mm



35W
Cut out: 200-210mm
Ø228x45mm



45W
Cut out: 230-260mm
Ø280x52mm

SPECIFICATIONS

Wattage	18W, 25W, 35W, 45W	Connection Type	Pre-wired with flex and plug
Lumens	1800, 2500, 3850, 4600	Driver Technology	Remote
lm/W	100	Voltage	220-240V
CCT	3000/4000/5700K	PF	>0.9
IP Rating	IP54(Front)/IP20(Back)	Frequency	50/60Hz
IK Rating	IK03	Mounting Type	Recessed mounting
Dimmable	Trailing edge	Operating Temperature	-25°C to 45°C
Housing Material	Aluminium	Lifetime	50000 hours
Beam Angle	100°	Warranty	5 years
CRI	>80		
SDCM	<6		
Electrical Classification	Class II		

PHOTOMETRICS

(Example of LDVDL35W200MMTRI)

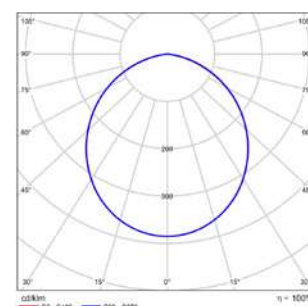

DIMENSIONS

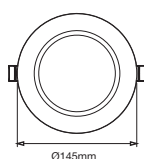
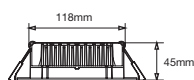

18W
Cut out: 120-130mm
Ø145x45mm

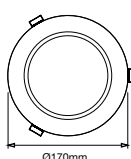
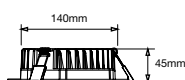

25W
Cut out: 140-150mm
Ø170x45mm

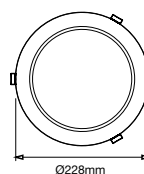
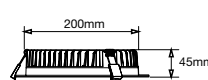

35W
Cut out: 200-210mm
Ø228x45mm

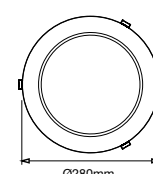
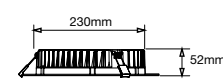

45W
Cut out: 230-260mm
Ø280x52mm

ORDERING CODES - COMMERCIAL DOWNLIGHT



Product name	EAN10	Model number	W	lm	K	°	lm/W	CUT OUT (mm)	°	∅ d (mm)	h (mm)	g
--------------	-------	--------------	---	----	---	---	------	--------------	---	----------	--------	---

COMMERCIAL DOWNLIGHT

LDVAL DLCOM 18W 120MM DIMTRI 30X1AU LEDV	4058075793484	LDVDL18W120MMTRI	18	1620/ 1800/ 1620	3000/ 4000/ 5700	90/ 100/ 90	100	120-130	✓	145	45	530
LDVAL DLCOM 25W 140MM DIMTRI 30X1AU LEDV	4058075793507	LDVDL25W140MMTRI	25	2350/ 2500/ 2375	3000/ 4000/ 5700	94/ 100/ 95	100	140-150	✓	170	45	650
LDVAL DLCOM 35W 200MM DIMTRI 10X1AU LEDV	4058075793521	LDVDL35W200MMTRI	35	3500/ 3850/ 3675	3000/ 4000/ 5700	100/ 110/ 105	100	200-210	✓	228	45	1050
LDVAL DLCOM 45W 230MM DIMTRI 10X1AU LEDV	4058075793545	LDVDL45W230MMTRI	45	4500/ 4600/ 4500	3000/ 4000/ 5700	100/ 102/ 100	100	230-260	✓	280	52	1550

1 Brightness can be adjusted using a compatible dimmer. See below table for applicative dimmer.

Dimmer brand	Dimming mode	LDVDL18W120MMTRI				LDVDL25W140MMTRI			
		Io-Min	Io-Max	Dimming range	Io-Min	Io-Max	Dimming range		
LEDVANCE DAU030M1-300	UNIVERSAL	3	455	0.67% 101.34%	4	614	0.66% 100.99%		
CLIPSAL LEADING EDGE	LEADING EDGE	14.8	449.1	3.30% 100.02%	34.8	608.1	5.72% 100.02%		
CLIPSAL32E450TM	TRAILING EDGE	6.7	452.5	1.49% 100.78%	26.7	611.5	4.39% 100.58%		
CLIPSAL32E450UDM	UNIVERSAL	19.5	452.4	4.34% 100.76%	39.5	611.4	6.50% 100.56%		
HPM CAT 400T	TRAILING EDGE	5.2	363.0	1.16% 80.85%	17.8	522.0	2.93% 85.86%		
CLIPSAL32E450LM	LEADING EDGE	40.8	447	9.09% 99.55%	60.8	606	10.00% 99.67%		
DIGINET MEDM/DGRT	TRAILING EDGE	1.5	451.5	0.33% 100.56%	1.5	610.5	0.25% 100.41%		
TRADER-DIMR-400W	TRAILING EDGE	0.0	451.3	0.00% 100.51%	0.0	610.3	0.00% 100.38%		
TRADER-DIMPR-400W	TRAILING EDGE	0.0	451.5	0.00% 100.56%	0.0	610.5	0.00% 100.41%		
HPM 200L 10-200W	TRAILING EDGE	33.3	410.3	7.42% 91.38%	53.3	569.3	8.77% 93.63%		
DETA-MODEI 6030/4-150W	TRAILING EDGE	4.5	452.5	1.00% 100.78%	16.5	611.5	2.71% 100.58%		
PDL-654M 20-450VA	TRAILING EDGE	17.6	452.4	3.92% 100.76%	37.6	611.4	6.18% 100.56%		
DIGINET MEDM 2-400W	TRAILING EDGE	0	451.5	0.00% 100.56%	0	610.5	0.00% 100.41%		
CBUS-L5504D2U	UNIVERSAL	2.8	456.1	0.62% 101.58%	10.8	615.1	1.78% 101.17%		
CABAC	TRAILING EDGE	13.1	448.2	2.92% 99.82%	33.1	607.2	5.44% 99.87%		

Table continued in next page.

Dimmer brand	Dimming mode	Io-Min	Io-Max	Dimming range		Io-Min	Io-Max	Dimming range	
		LDVDL35W200MMTRI				LDVDL45W230MMTRI			
LEDVANCE DAU030M1-300	UNIVERSAL	5	814	0.62%	101.50%	6	1053	0.57%	100.57%
CLIPSAL LEADING EDGE	LEADING EDGE	44.4	804.0	5.54%	100.25%	52.5	1055.0	5.01%	100.76%
CLIPSAL32E450TM	TRAILING EDGE	31.9	808.2	3.98%	100.77%	42.3	1060.0	4.04%	101.24%
CLIPSAL32E450UDM	UNIVERSAL	47.5	807.1	5.92%	100.64%	62.2	1057.0	5.94%	100.96%
CLIPSAL32E450LM	LEADING EDGE	81.7	800.9	10.19%	99.86%	104.9	1050.0	10.02%	100.29%
TRADER-DIMR-400W	TRAILING EDGE	0.0	804.4	0.00%	100.30%	0.0	1057.0	0.00%	100.96%
TRADER-DIMPR-400W	TRAILING EDGE	0.0	802.2	0.00%	100.02%	0.0	1040.0	0.00%	99.33%
HPM 200L 10-200W	LEADING EDGE	70.8	751.8	8.83%	93.74%	83.8	989.1	8.00%	94.47%
DETA-MODEI 6030/4-150W	TRAILING EDGE	19.2	769.7	2.39%	95.97%	24.8	1065.0	2.37%	101.72%
PDL-654M 20-450VA	TRAILING EDGE	45	802.6	5.61%	100.07%	57.7	1059.0	5.51%	101.15%
DIGINET MEDM 2-400W	TRAILING EDGE	0	803.2	0.00%	100.15%	0	1062	0.00%	101.43%
CBUS-L5504D2U	UNIVERSAL	13.8	806.3	1.72%	100.54%	16.8	1074	1.60%	102.58%
CABAC	TRAILING EDGE	39.8	781.1	4.96%	97.39%	51.1	1050	4.88%	100.29%

Surface Mount Downlight

Surface Mount Downlight available in both 18W and 24W options and two sizes. With tri colour options and high efficacy up to 90 lm/W, this downlight is not only energy-efficient but also versatile. Quick and easy to install without recessing required. Upgrade your lighting game with LEDVANCE reliable and efficient Surface Mount Downlight.



FEATURES AND BENEFITS

- 18W, 24W
- Available in Ø165mm and Ø215mm
- Tri colour in 3000K, 4000K and 6500K
- High efficacy up to 90 lm/W
- IP44
- Pre-wired with 1m flex and plug
- Lifetime 25000 hours

AREAS OF APPLICATION

- Public spaces
- Dry residential such as bedrooms and living areas.
- Reception areas and foyers
- Entrances and hallways
- Retail and hospitality

AVAILABLE SIZES



18W
Ø165x48mm



24W
Ø215x49mm

SPECIFICATIONS

Wattage	18W, 24W	Connection Type	1m flex and plug
Lumens	1620, 2160	Driver Technology	Integral
lm/W	90	Voltage	220-240V
CCT	3000/4000/6500K	PF	0.5
IP Rating	IP44(front)/IP20(back)	Frequency	50/60Hz
Double Insulated	Yes	Surge Protection	500V
Housing Material	PMMA	Mounting Type	Surface mounting
Beam Angle	90°	Operating Temperature	-20°C to 40°C
CRI	>80	Lifetime	25000 hours
SDCM	<6	Warranty	5 years
Electrical Classification	Class II		

PHOTOMETRICS

(Example of LDVDLSR24WTRI)

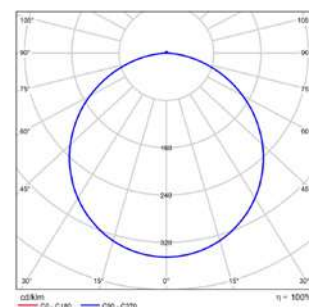

DIMENSIONS

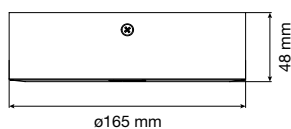

18W
Ø165x48mm

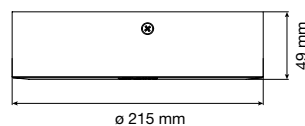
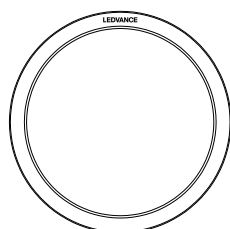

24W
Ø215x49mm

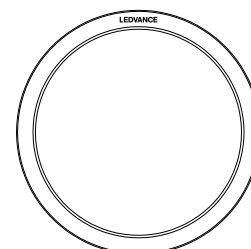

ORDERING CODES - SURFACE MOUNT DOWNLIGHT



Product name	EAN10	Model number	W	lm	K	°	lm/W		Ø d (mm)	h (mm)	
--------------	-------	--------------	---	----	---	---	------	--	----------	--------	--

SURFACE MOUNT DOWNLIGHT

LDECO DL SR165 18W TRI WT 40X1G2 AULEDV	4099854181528	LDVDSL18WTRI	18	1620	3000/ 4000/ 6500	75	90	×	165	48	242
LDECO DL SR215 24W TRI WT 40X1G2 AULEDV	4099854181542	LDVDSL24WTRI	24	2160	3000/ 4000/ 6500	75	90	×	215	49	336

SURFACE MOUNT DOWNLIGHT



SURFACE MOUNT DOWNLIGHT

Ultra Commercial Downlight

The Ultra Commercial Downlight offers an economical solution for both new projects and the replacement of larger diameter luminaires. Its quick and easy installation makes it a practical choice, while its IP54 rating ensures suitability for damp areas. With cut out sizes ranging from 92mm to 240mm, finding the perfect fit for any application is effortless. Additionally, users can easily select lumen outputs and colour options, with the availability of phase dimming and DALI options adding further flexibility to its functionality.



FEATURES AND BENEFITS

- Phase dim: 10.5W, 12W, 14W, 19/14W, 20/14W, 30/23W, 40/30W
DALI: 11W, 14.5W, 18W, 18/15W, 20/16W, 29/23W, 39/29W
- Cut out size in 92mm, 118mm, 135mm, 160mm, 195mm, 240mm
- Tri colour in 3000K, 4000K, and 5700K
- High efficacy up to 135 lm/W
- Available in phase dimming and DALI
- IP54
- Pre-wired with 1.6m flex and plug
- Lifetime 50000 hours

AREAS OF APPLICATION

- Public spaces
- Reception areas and foyers
- Entrances and hallways
- Retail and hospitality
- Commercial buildings and lobbies

AVAILABLE SIZES



Phase dim: 10.5W
DALI: 11W
Cut out size: 92mm



Phase dim: 14W
DALI: 14.5W
Cut out size: 118mm



Phase dim: 19/14W
DALI: 18W, 18/15W
Cut out size: 135mm



Phase dim: 20/14W
DALI: 20/16W
Cut out size: 160mm



Phase dim: 12W, 30/23W
DALI: 29/23W
Cut out size: 195mm



Phase dim: 40/30W
DALI: 39/29W
Cut out size: 240mm

SPECIFICATIONS

Wattage	Phase dim: 10.5W, 12W, 14W, 19/14W, 20/14W, 30/23W, 40/30W DALI: 11W, 14.5W, 18W, 18/15W, 20/16W, 29/23W, 39/29W	Electrical Classification	Class II
lm/W	135	Connection Type	Pre-wired with 1.6m flex and plug
CCT	3000/4000/5700K	Driver Technology	Remote
IC Rating	IC-4	Voltage	220-240V
IP Rating	IP54(Front)/IP20(Back)	PF	>0.9
Dimmable	Phase dim, DALI	Frequency	50/60 Hz
Housing Material	Polycarbonate	Flicker Rate	<5%
Beam Angle	100°	Mounting Type	Recessed mounting
CRI	>80	Operating Temperature	-20°C to 40°C
SDCM	≤5	Lifetime	50000 hours
		Warranty	5 years

PHOTOMETRICS

(Example of LDVDL14WTRIDIM)

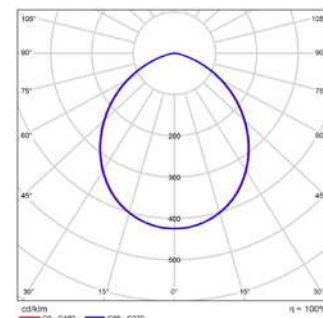

DIMENSIONS

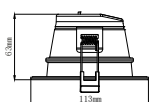

Cut out size: 92mm
Ø113x63mm

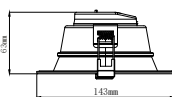

Cut out size: 118mm
Ø143x63mm

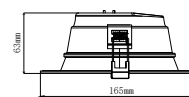

Cut out size: 135mm
Ø165x63mm

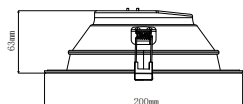

Cut out size: 160mm
Ø200x63mm

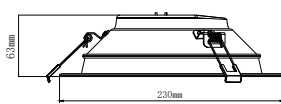

Cut out size: 195mm
Ø230x63mm

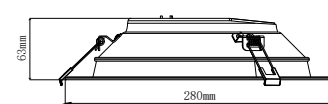

Cut out size: 240mm
Ø280x63mm

ORDERING CODES - ULTRA COMMERCIAL DOWNLIGHT



Product name	EAN10	Model number	W	lm	K	°	lm/w	CUT OUT (mm)	Ø d (mm)	W (mm)	h (mm)
--------------	-------	--------------	---	----	---	---	------	--------------	----------	--------	--------

SINGLE WATTAGE - PHASE DIMMING

LDVAL DL 10.5W 92MM TRI DIM WH8X1AULEDV	4099854333774	LDVDL10.5WTRIDIM	10.5	950/1100/1050	3000/4000/5700	100	105	92	PHASE DIM	113	63	285
LDVAL DL 14W 118MM TRI DIM WH 8X1AULEDV	4099854333798	LDVDL14WTRIDIM	14	1350/1550/1450	3000/4000/5700	100	110	118	PHASE DIM	143	63	354
LDVAL DL 12W 195MM TRI DIM WH 8X1AULEDV	4099854333859	LDVDL12WTRIDIM	12	1450/1600/1550	3000/4000/5700	100	135	195	PHASE DIM	230	63	475

DUAL WATTAGE - PHASE DIMMING

LDVAL DL 14/19W 135MM TRI DIMWH8X1AULEDV	4099854333811	LDVDL19/14WTRIDIM	19/14	1800/2100/2000 1400/1600/1500	3000/4000/5700	100	115	135	PHASE DIM	165	63	360
LDVAL DL 14/20W 160MM TRI DIMWH8X1AULEDV	4099854333835	LDVDL20/14WTRIDIM	20/14	2100/2500/2300 1500/1750/1650	3000/4000/5700	100	125	160	PHASE DIM	200	63	380
LDVAL DL 23/30W 195MM TRI DIMWH8X1AULEDV	4099854333873	LDVDL30/23WTRIDIM	30/23	3150/3900/3450 2400/2950/2650	3000/4000/5700	100	130	195	PHASE DIM	230	63	475
LDVAL DL 30/40W 240MM TRI DIMWH8X1AULEDV	4099854333897	LDVDL40/30WTRIDIM	40/30	4200/4900/4600 3200/3700/3500	3000/4000/5700	100	125	240	PHASE DIM	280	63	592

SINGLE WATTAGE - DALI



LDVAL DL 11W 92MM TRI DALI WH 8X1AULEDV	4099854333910	LDVDL11WTRIDALI	11	1000/1100/1100	3000/4000/5700	100	105	92	DALI	113	63	270
LDVAL DL 14.5W 118MM TRI DALIWH8X1AULEDV	4099854333934	LDVDL14.5WTRIDALI	14.5	1350/1550/1500	3000/4000/5700	100	110	118	DALI	143	63	295
LDVAL DL 18W 135MM TRI DALI WH8X1AULEDV	4099854333958	LDVDL18WTRIDALI	18	1700/2050/1900	3000/4000/5700	100	115	135	DALI	165	63	396

DUAL WATTAGE - DALI



LDVAL DL 15/18W 135MM TRI DAL WH8X1AULEDV	4099854333972	LDVDL18/15WTRIDALI	18/15	1700/2050/1900 1400/1700/1550	3000/4000/5700	100	115	135	DALI	165	63	365
LDVAL DL 16/20W 160MM TRI DALIWH8X1AULEDV	4099854333996	LDVDL20/16WTRIDALI	20/16	2100/2500/2300 1650/1950/1850	3000/4000/5700	100	125	160	DALI	200	63	421
LDVAL DL 23/29W 195MM TRI DALIWH8X1AULEDV	4099854334016	LDVDL29/23WTRIDALI	29/23	3050/3750/3350 2400/2950/2650	3000/4000/5700	100	130	195	DALI	230	63	490
LDVAL DL 29/39W 240MM TRI DALIWH8X1AULEDV	4099854334030	LDVDL39/29WTRIDALI	39/29	4100/4800/4450 3050/3600/3350	3000/4000/5700	100	125	240	DALI	280	63	605





LED PANEL

Applications: Public areas | Offices | Corridors | Foyers | Conference rooms

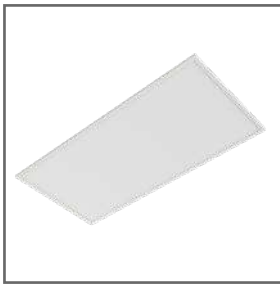

ECO PANEL

50

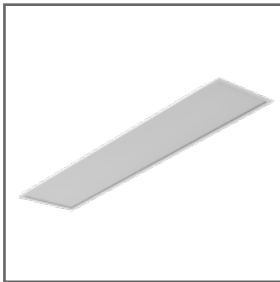

PANEL PLUS

54

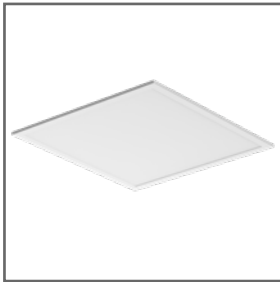

HIGH OUTPUT PANEL

58

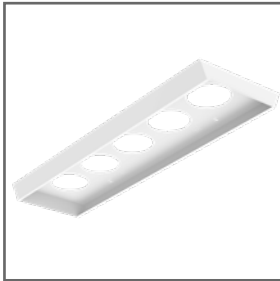

SURFACE MOUNT FRAME

62

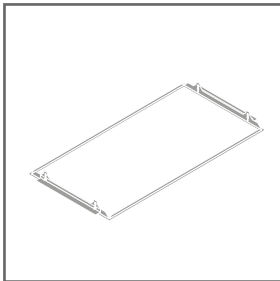

UNIVERSAL PANEL ACCESSORIES

64

Eco Panel

Eco Panel offers options of 36W and 65W, it's available in 3 sizes: 600x600mm, 300x1200mm, and 600x1200mm. Single colour in either 4000K or 6500K. Achieving high efficacy up to 90lm/W, its 120° beam angle ensures widespread coverage. Pre-wired with flex and plug for easy installation, its impressive 50000 hours lifespan ensures enduring brilliance.

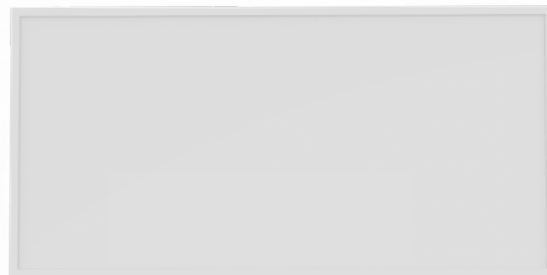

FEATURES AND BENEFITS

- 36W, 65W
- Available in 600x600mm, 300x1200mm and 600x1200mm
- Single colour in 4000K or 6500K
- High efficacy up to 90lm/W
- Beam angle 120°
- Low glare rating of UGR<22
- IP40
- Pre-wired with flex and plug
- Lifetime 50000 hours

AREAS OF APPLICATION

- Offices and conference rooms
- Reception areas and foyers
- Entrances and hallways
- Retail and hospitality
- Libraries and schools

AVAILABLE SIZES



36W
595x595x32mm



36W
1195x295x32mm



65W
1195x595x34mm

ECO PANEL

SPECIFICATIONS

Wattage	36, 65W	Connection Type	Pre-wired with flex and plug
Lumens	3240, 5850	Voltage	220-240V
lm/W	90	Input Current	200mA, 340mA
CCT	4000K, 6500K	PF	>0.9
IP Rating	IP40(Front)/IP20(Back)	Frequency	50/60Hz
Dimmable	Fast connector	Surge Protection	1KV
Housing Material	PMMA	Mounting Type	Recessed mounting
Beam Angle	120°	Operating Temperature	-10°C to 40°C
CRI	>80	Lifetime	50000 hours
UGR	<22	Warranty	5 years
SDCM	<5		
Electrical Classification	Class II		

PHOTOMETRICS

(Example of LDVPAN060636W840)

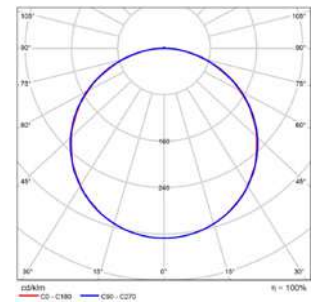

DIMENSIONS

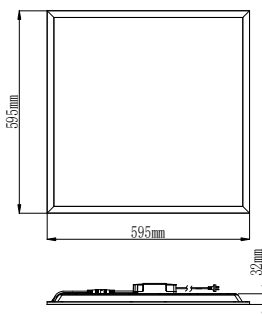

36W
595x595x32mm

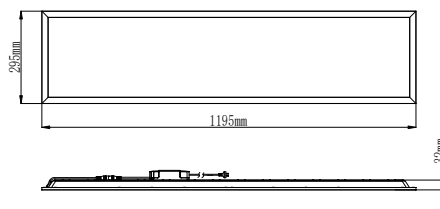

36W
1195x295x32mm

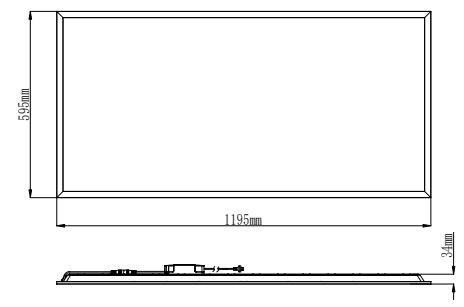

65W
1195x595x34mm

ORDERING CODES - ECO PANEL



Product name	EAN10	Model number	W	lm	K	Δ	lm/w	\curvearrowright	\perp (mm)	h (mm)	w (mm)	
--------------	-------	--------------	---	----	---	----------	------	--------------------	--------------	--------	--------	--

ECO PANEL

LDECO PANEL 0606 36W 840 6X1 AU LEDV	4099854245015	LDVPAN060636W840	36	3240	4000	120	90	FAST CONNECTOR	595	595	32	1516
LDECO PANEL 0606 36W 865 6X1 AU LEDV	4099854245039	LDVPAN060636W865	36	3240	6500	120	90	FAST CONNECTOR	595	595	32	1516
LDECO PANEL 0312 36W 840 6X1 AU LEDV	4099854245053	LDVPAN031236W840	36	3240	4000	120	90	FAST CONNECTOR	1195	295	32	1516
LDECO PANEL 0312 36W 865 6X1 AU LEDV	4099854245077	LDVPAN031236W865	36	3240	6500	120	90	FAST CONNECTOR	1195	295	32	1516
LDECO PANEL 0612 65W 840 4X1 AU LEDV	4099854245091	LDVPAN061265W840	65	5850	4000	120	90	FAST CONNECTOR	1195	595	34	3151
LDECO PANEL 0612 65W 865 4X1 A LEDV	4099854245114	LDVPAN061265W865	65	5850	6500	120	90	FAST CONNECTOR	1195	595	34	3151



Panel Plus

The Panel Plus, designed to cater to diverse lighting needs at an affordable price. Featuring dual wattage, phase dim and DALI options, this panel is complemented by a low-glare diffuser (UGR<19) making it perfect for both office settings and classrooms. Its versatile TRI colour switch allows for seamless transitions between warm white, cool white and daylight. Built for lasting performance, the IP54-rated luminaire is dust-protected and suitable for damp environments, providing reliable lighting solutions.

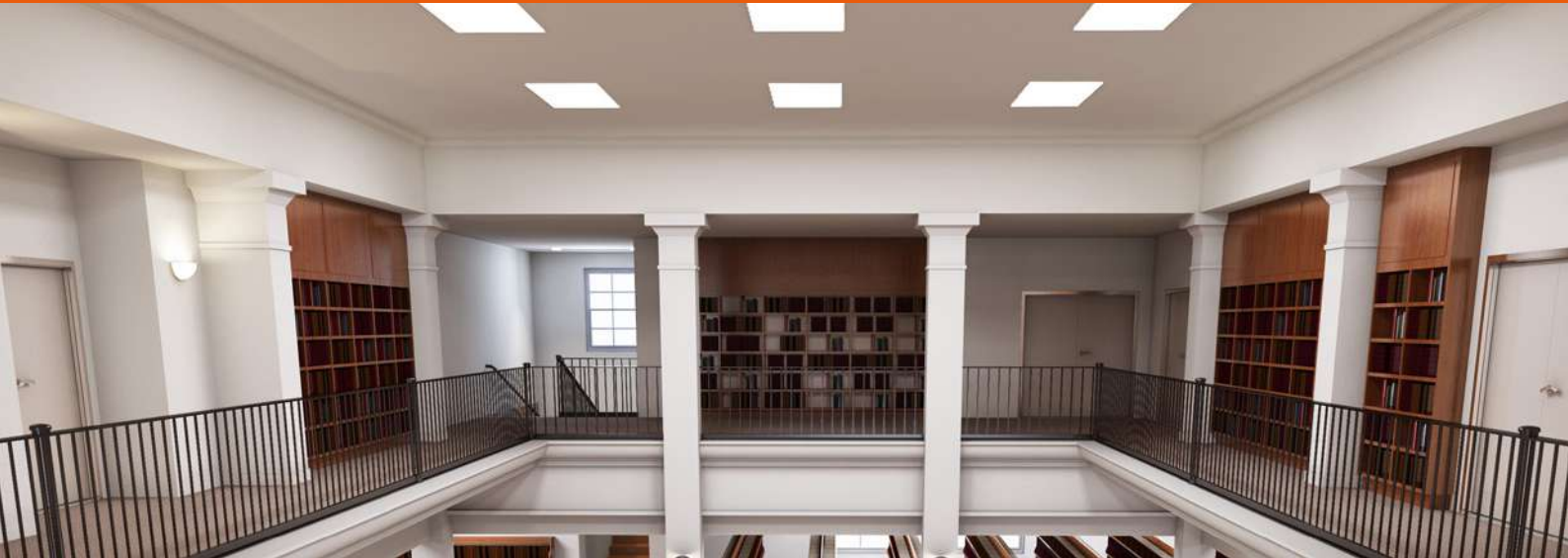

FEATURES AND BENEFITS

- Dual wattage version: 20/15W, 33/27W or 49/45W
- Phase dim version: 33W, 49W
- DALI version: 33W, 49W
- Available in 300x600mm, 600x600mm, 300x1200mm and 600x1200mm
- Tri colour in 3000K, 4000K, and 5700K
- High efficacy up to 120lm/W
- Low glare rating of UGR<19
- IP54
- Pre-wired with flex and plug
- Lifetime 50000 hours

AREAS OF APPLICATION

- Offices and conference rooms
- Reception areas and foyers
- Entrances and hallways
- Retail and hospitality
- Libraries and schools

AVAILABLE SIZES



20/15W
595x295x32mm

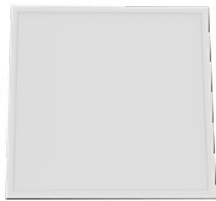

33/27W
595x595x32mm



33/27W
1195x295x32mm



49/45W
1195x595x34mm

SPECIFICATIONS

Wattage	20/15W, 33/27W, 49/45W	Connection Type	Pre-wired with flex and plug
Lumens	2400, 4000, 5850	PF	>0.9
lm/W	120	Voltage	220-240V
CCT	3000/4000/5700K	Input Current	58/120mA, 105/200mA, 170/280mA
IP Rating	IP54(Front)/IP20(Back)	Frequency	50/60Hz
Dimmable	Phase dim/DALI	Surge Protection	1KV
Housing Material	PMMA	Mounting Type	Recessed mounting
Beam Angle	90°	Operating Temperature	-10°C to 40°C
CRI	>80	Lifetime	50000 hours
SDCM	<5	Warranty	5 years
UGR	<19		
Electrical Classification	Class II		

PHOTOMETRICS

(Example of LDVPAN060633/27WTRI)

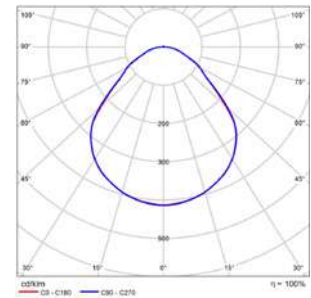

DIMENSIONS

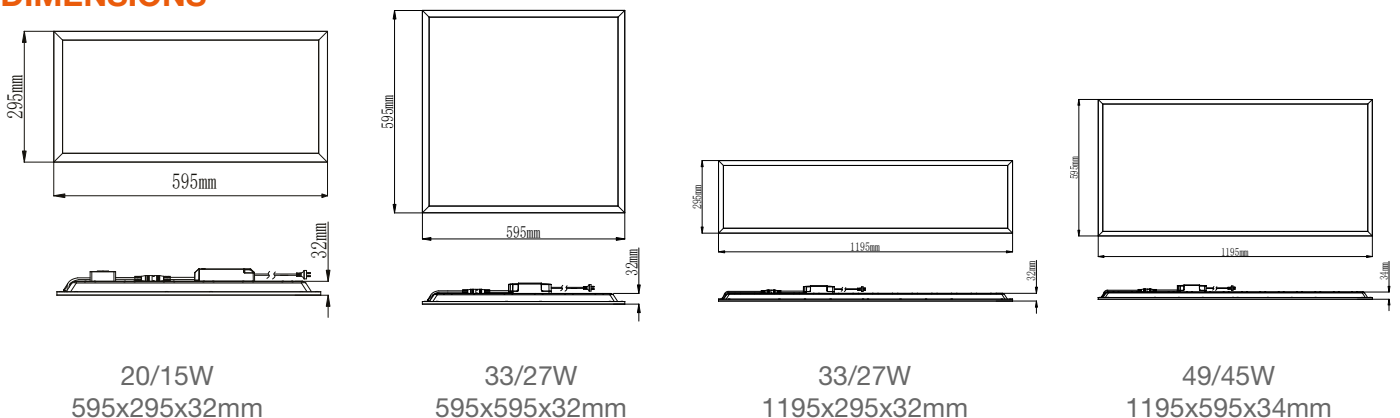

ORDERING CODES - PANEL PLUS



Product name	EAN10	Model number	W	lm	K	°	lm/w	°	L [mm]	w [mm]	h [mm]	9
--------------	-------	--------------	---	----	---	---	------	---	--------	--------	--------	---

DUAL WATTAGE

LDVAL PAN0306 20/15W TRI UGR19 6X1AULEDV	4099854298257	LDVPAN030620/15WTRI	20/15	2400/1800	3000/4000/5700	90	120	×	595	295	32	1000
LDVAL PAN0606 33/27W TRIUGR19 6X1AULEDV	4099854246944	LDVPAN060633/27WTRI	33/27	4000/3240	3000/4000/5700	90	120	×	595	595	32	1834
LDVAL PAN0312 33/27W TRIUGR19 6X1AULEDV	4099854246968	LDVPAN031233/27WTRI	33/27	4000/3240	3000/4000/5700	90	120	×	1195	295	32	1844
LDVAL PAN0612 49/45W TRIUGR19 4X1AULEDV	4099854246982	LDVPAN061249/45WTRI	49/45	5850/5400	3000/4000/5700	90	120	×	1195	595	34	3634

PHASE DIM

LDVAL PAN0606 33W TRI UGR19DIM6X1AULEDV	4099854247132	LDVPAN060633WTRIDIM	33	4000	3000/4000/5700	90	120	PHASE DIM	595	595	32	1875
LDVAL PAN0312 33W TRI UGR19DIM6X1AULEDV	4099854247156	LDVPAN031233WTRIDIM	33	4000	3000/4000/5700	90	120	PHASE DIM	1195	295	32	1885
LDVAL PAN0612 49W TRI UGR19DIM4X1AULEDV	4099854247170	LDVPAN061249WTRIDIM	49	5850	3000/4000/5700	90	120	PHASE DIM	1195	595	34	3770

DALI



LDVAL PAN0606 33W TRIUGR19DALI6X1AULEDV	4099854247002	LDVPAN060633WTRIDALI	33	4000	3000/4000/5700	90	120	DALI	595	595	32	1930
LDVAL PAN0312 33W TRIUGR19DALI6X1AULEDV	4099854247057	LDVPAN031233WTRIDALI	33	4000	3000/4000/5700	90	120	DALI	1195	295	32	1940
LDVAL PAN0612 49W TRIUGR19DALI4X1AULEDV	4099854247095	LDVPAN061249WTRIDALI	49	5850	3000/4000/5700	90	120	DALI	1195	595	34	3700



High Output Panel

The High Output Panel has high efficacy achieving a luminous flux of 6000 lumens. With a low glare rating of UGR19, this classic style panel is the perfect solution for your office lighting. All panel sizes can be surface mounted, recessed or suspended making it the ideal replacement for traditional troffer fittings. Also available in DALI.

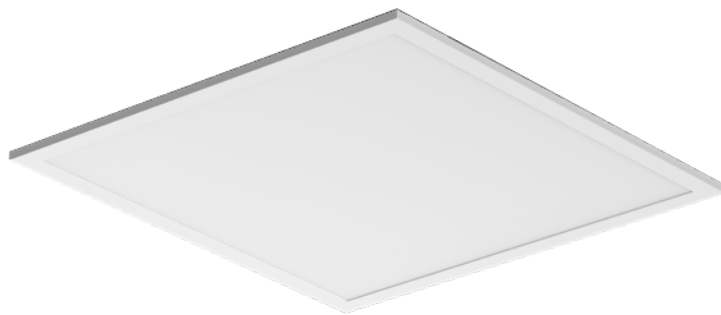

FEATURES AND BENEFITS

- 25W, 36W, 50W
- Available in 300x600mm, 600x600mm, 300x1200mm and 600x1200mm
- Single colour in 4000K, and 5700K
- High efficacy up to 120lm/W
- DALI option available
- Beam angle 90°
- Low glare rating of UGR<19
- IP40
- Pre-wired with flex and plug
- Lifetime 60000 hours

AREAS OF APPLICATION

- Offices and conference rooms
- Reception areas and foyers
- Entrances and hallways
- Retail and hospitality
- Libraries and schools

AVAILABLE SIZES



25W
295x595x32mm



36W
295x1195x32mm



36W
595x595x32mm



50W
595x1195x32mm

SPECIFICATIONS

Wattage	25W, 36W, 50W	Electrical Classification	Class II
Lumens	3000, 4320, 6000	Connection Type	Pre-wired with flex and plug
lm/W	120	PF	>0.9
CCT	4000K, 5700K	Frequency	50/60Hz
IP Rating	IP20	Mounting Type	Recessed mounting
IK Rating	IK02	Operating Temperature	-20°C to 50°C
Housing Material	Aluminium	Lifetime	60000 hours
Beam Angle	90°	Warranty	5 years
CRI	>80		
UGR	<19		

PHOTOMETRICS

(Example of LDVPANHO031236W840)

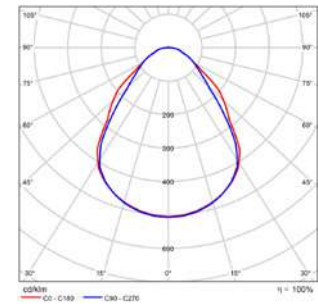

DIMENSIONS

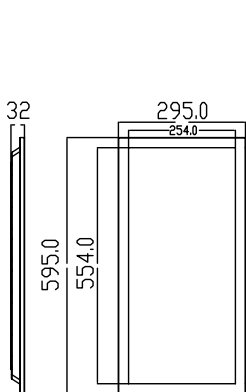

25W
295x595x32mm

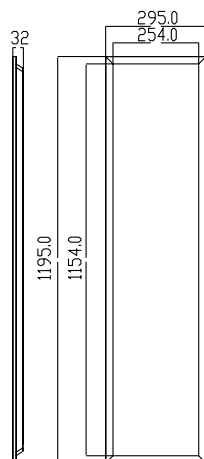

36W
295x1195x32mm

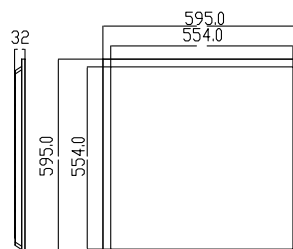

36W
595x595x32mm

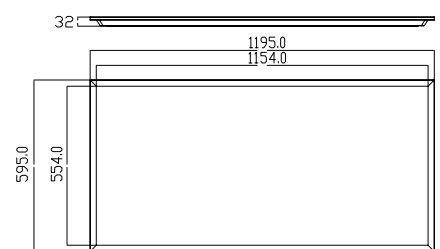

50W
595x1195x32mm

ORDERING CODES - HIGH OUTPUT PANEL

VALUE
CLASS

Product name

EAN10

Model number



HIGH OUTPUT PANEL

LDVAL PANEL H00306 25W840UGR194X1AULEDV	4058075505445	LDVPANHO030625W840	25	3000	4000	90	120	×	595	295	32	1120
LDVAL PANEL H00306 25W857UGR194X1AULEDV	4058075505469	LDVPANHO030625W857	25	3000	5700	90	120	×	595	295	32	1120
LDVAL PANEL H00606 36W840UGR194X1AULEDV	4058075505483	LDVPANHO060636W840	36	4320	4000	90	120	×	595	595	32	1940
LDVAL PANEL H00606 36W857UGR194X1AULEDV	4058075505506	LDVPANHO060636W857	36	4320	5700	90	120	×	595	595	32	1940
LDVAL PANEL H00312 36W840UGR194X1AULEDV	4058075505520	LDVPANHO031236W840	36	4320	4000	90	120	×	1195	295	32	1360
LDVAL PANEL H00312 36W857UGR194X1AULEDV	4058075505544	LDVPANHO031236W857	36	4320	5700	90	120	×	1195	295	32	1360
LDVAL PANEL H00612 50W840UGR194X1AULEDV	4058075505568	LDVPANHO061250W840	50	6000	4000	90	120	×	1195	595	32	4050
LDVAL PANEL H00612 50W857UGR194X1AULEDV	4058075505582	LDVPANHO061250W857	50	6000	5700	90	120	×	1195	595	32	4050

1 DALI dimmable version on request, subject to MOQ.



HIGH OUTPUT PANEL

Surface Mount Frame

The pre-assembled Surface Mount Frames for LED panels are a great solution for quick and easy installation. Made from durable steel, these frames provide the necessary support for LEDVANCE panels. Stylish Designed frame, ideal for surface mounting LED panels. Strong powder coated steel construction.

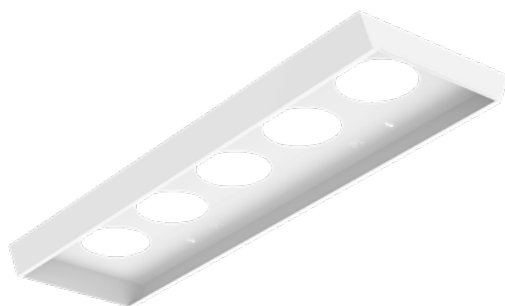

FEATURES AND BENEFITS

- Pre assembled surface mount frames
- Powder coated steel frame
- Suitable for 1200x300mm or 600x600mm panel
- No assembly required, quick to install
- Can be suspended
- Multiple fixing holes and cable entries, ideal for retrofit projects

AREAS OF APPLICATION

- Offices and conference rooms
- Reception areas and foyers
- Entrances and hallways
- Retail and hospitality
- Libraries and schools

AVAILABLE SIZES

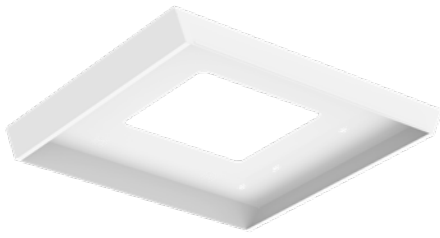

LDVPANSMF0606
600x654x65.5mm

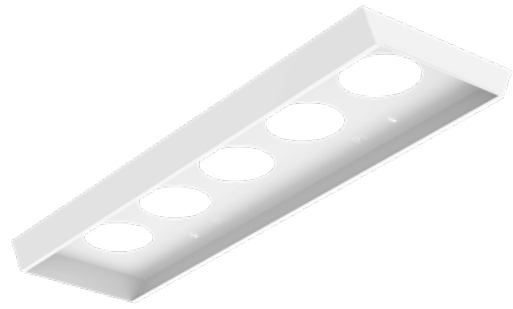

LDVPANSMF0312
1200x354x65.5mm

DIMENSIONS

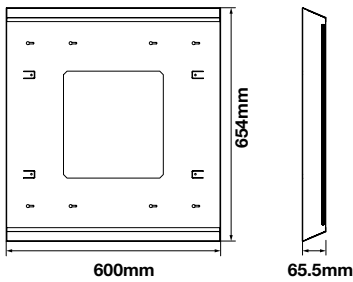

LDVPANSMF0606
600x654x65.5mm

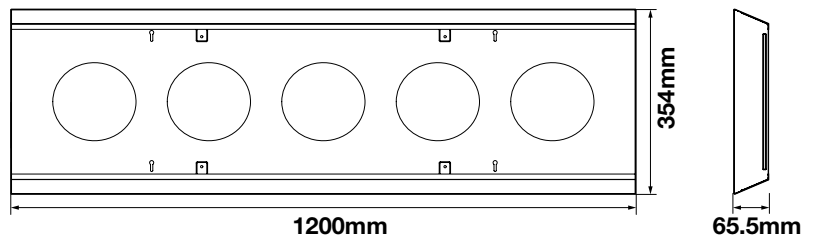

LDVPANSMF0312
1200x354x65.5mm

SURFACE MOUNT FRAME

ORDERING CODES - SURFACE MOUNT FRAME



Product name	EAN10	Model number				
--------------	-------	--------------	--	--	--	--

SURFACE MOUNT FRAME 600X600

LDVAL PAN SURFACE FRAME 0606 2X1 AULEDV	4099854246760	LDVPANSMF0606	600	654	65.5	2280
---	---------------	---------------	-----	-----	------	------

SURFACE MOUNT FRAME 1200X300

LDVAL PAN SURFACE FRAME 0312 2X1 AULEDV	4099854246746	LDVPANSMF0312	1200	354	65.5	2690
---	---------------	---------------	------	-----	------	------

Universal Panel Accessories

Various mounting options available with LEDVANCE Universal Panel accessories. All LEDVANCE Panels are compatible with our range of plaster recess frames, surface mounting frames and suspension kits.

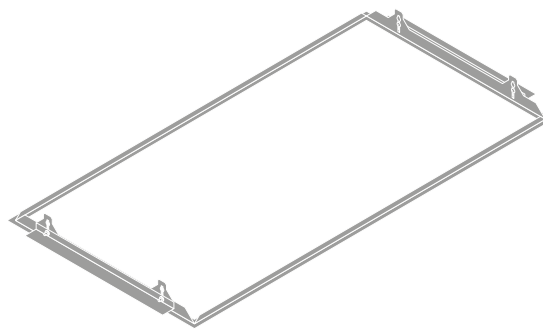

FEATURES AND BENEFITS







- Suitable for all LEDVANCE panels
- Surface, recessed or suspension suitable for all application

AREAS OF APPLICATION

- Offices and conference rooms
- Reception areas and foyers
- Entrances and hallways
- Retail and hospitality
- Libraries and schools

ORDERING CODES - UNIVERSAL PANEL ACCESSORIES

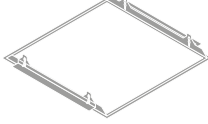
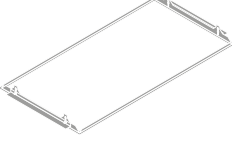
VALUE
CLASSLEDVANCE
5 year
guarantee

Product name	EAN10	Model number				
RECESSED CEILING KITS 600X600						
						
LDVAL PAN RECESSKIT 0606 G2 4X1 AU LEDV	4058075737563	LDVPANRECESSK0606	634	634	38.1	598
RECESSED CEILING KITS 300X600 300X1200 600X1200						
						
LDVAL PAN RECESSKIT 0306 G2 4X1 AU LEDV	4058075737501	LDVPANRECESSK0306	634	334	38.1	455
LDVAL PAN RECESSKIT 0312 G2 4X1 AU LEDV	4058075737594	LDVPANRECESSK0312	1234	234	38.1	755
LDVAL PAN RECESSKIT 0612 G2 4X1 AU LEDV	4058075737624	LDVPANRECESSK0612	1234	634	38.1	899
SUSPENSION KITS						
						
LDVAL PAN SUSKIT G2 10X1 AU LEDV	4058075737655	LDVPANSUSKIT	1500	N/A	N/A	105



LINEAR

Applications: Public areas | Shops | Stairways | Corridors | Foyers | Offices

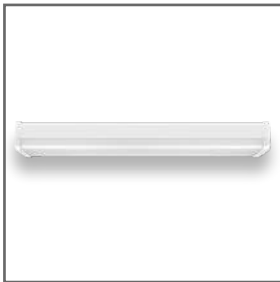

TRI COLOUR MULTI WATTAGE BATTEN - SLIM 68

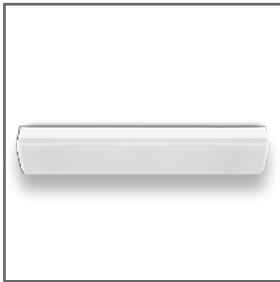

TRI COLOUR MULTI WATTAGE BATTEN - WIDE 72

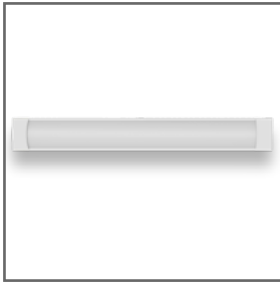

BLADE BATTEN 76



LINKABLE BATTEN 80



MINI BATTEN 84

Tri Colour Multi Wattage Batten - Slim

The Slim Tri Colour Multi Wattage Batten - Slim with dual wattage switch for ultimate versatility in one fitting. As a direct replacement for T5 and T8 fluorescent tubes, the slim batten is ideal for either commercial or residential space. Further functions available to suit your application needs such as DALI, emergency and micro sensors.

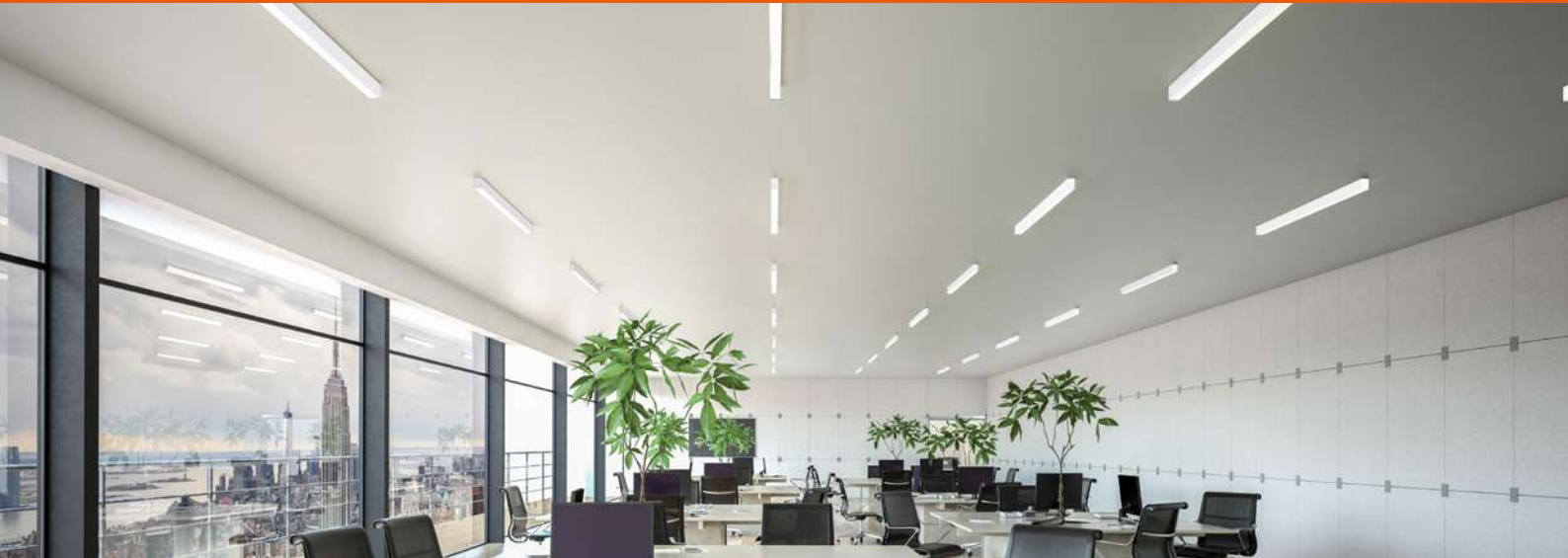

FEATURES AND BENEFITS

- 20/12W, 40/22W
- Available in 600x75mm and 1185x75mm
Tri colour in 3000K, 4000K and 5700K
- High efficacy up to 100lm/W
- DALI, Emergency and sensor options available
- Beam angle 120°
- IP20
- Polycarbonate housing
- Easy install thanks to 6mm terminal block
- Lifetime 50000 hours

AREAS OF APPLICATION

- Reception areas and foyers
- Garages
- Corridors, stairways, and entrance areas
- Entrances and hallways
- Retail and hospitality

AVAILABLE SIZES

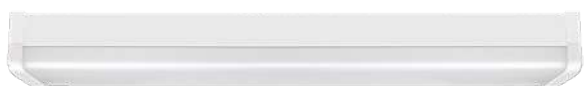

20/12W
600x75x73mm



40/22W
1185x75x73mm

SPECIFICATIONS

Wattage	20/12W, 40/22W	Connection Type	Terminal block
Lumens	2200, 4400	Beam Angle	120°
lm/W	100	CRI	>80
CCT	3000K/4000K/5700K	SDCM	<6
IP Rating	IP20	Electrical Classification	Class II
Dimmable	DALI option available	PF	>0.9
Sensor	Sensor option available	Frequency	50/60Hz
Emergency Battery	LiFePO4	Mounting Type	Surface mounting
Emergency Duration	180 minutes	Operating Temperature	-20°C to 40°C
Housing Material	Polycarbonate	Lifetime	50000 hours
		Warranty	5 years

PHOTOMETRICS

Example of LDVBAT12002240WTRI)

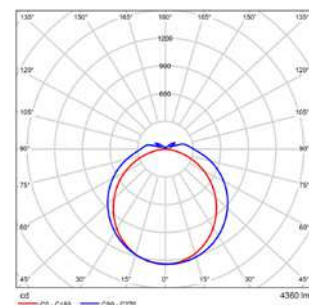

DIMENSIONS

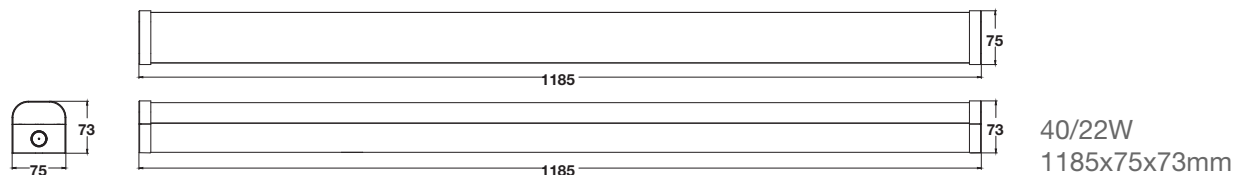
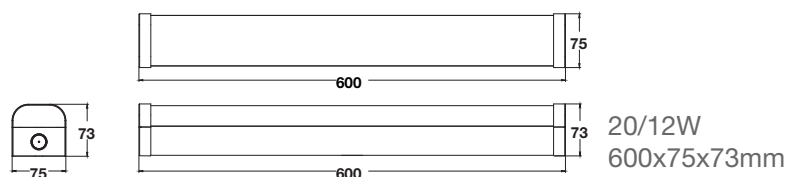

ORDERING CODES - TRI COLOUR MULTI WATTAGE BATTEN - SLIM

VALUE CLASS

Product name	EAN10	Model number	W	lm	K	°	lm/W	°	L (mm)	w (mm)	h (mm)	Person icon
--------------	-------	--------------	---	----	---	---	------	---	--------	--------	--------	-------------

STANDARD

LDV BAT 600 12/20W TRI G2 6X1 AU LEDV	4058075603233	LDVBAT6001220WTRI	20/12	1100/ 2200	3000/ 4000/ 5700	120	90/ 100	×	600	75	73	880
LDV BAT 1200 22/40W TRI G2 6X1 AU LEDV	4058075616493	LDVBAT12002240WTRI	40/22	2420/ 4400	3000/ 4000/ 5700	120	90/ 100	×	1185	75	73	1700

VALUE CLASS

Product name	EAN10	Model number	W	lm	K	°	lm/W	°	L (mm)	w (mm)	h (mm)	Person icon
--------------	-------	--------------	---	----	---	---	------	---	--------	--------	--------	-------------

MICROWAVE SENSOR

LDV BAT 1200 22/40W TRI MSG2 6X1AU LEDV	4058075616592	LDVBAT12002240WTRIMS	40/22	2420/ 4400	3000/ 4000/ 5700	120	90/ 100	×	1185	75	73	1700
--	----------------------	----------------------	-------	---------------	------------------------	-----	------------	---	------	----	----	------

VALUE CLASS

Product name	EAN10	Model number	W	lm	K	°	lm/W	°	L (mm)	w (mm)	h (mm)	Person icon
--------------	-------	--------------	---	----	---	---	------	---	--------	--------	--------	-------------

DALI

LDV BAT 1200 40W TRI DALI G2 6X1AU LEDV	4058075616578	LDVBAT120040WTRIDALI	40	4400	3000/ 4000/ 5700	120	90/ 100	DALI	1185	75	73	1700
--	----------------------	----------------------	----	------	------------------------	-----	------------	------	------	----	----	------

VALUE CLASS

Product name	EAN10	Model number	W	lm	K	°	lm/W	°	L (mm)	w (mm)	h (mm)	Person icon	Emergency icon
--------------	-------	--------------	---	----	---	---	------	---	--------	--------	--------	-------------	----------------

EMERGENCY

LDV BAT 1200 22/40W TRI EMG2 6X1AU LEDV	4058075616554	LDVBAT12002240WTRIEM	40/22	2420/ 4400	3000/ 4000/ 5700	120	90/ 100	×	1185	75	73	1700	180
--	----------------------	----------------------	-------	---------------	------------------------	-----	------------	---	------	----	----	------	-----

*5 years (1 year on emergency battery)



TRI COLOUR MULTI WATTAGE BATTEN - SLIM

Tri Colour Multi Wattage Batten - Wide

The Wide Tri Colour Multi Wattage Batten - Wide with dual wattage switch for ultimate versatility in one fitting. As a direct replacement for T5 and T8 fluorescent tubes, the wide batten is ideal for either commercial or residential space.

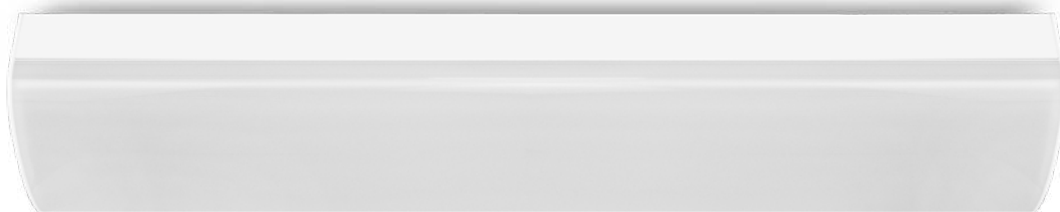

FEATURES AND BENEFITS

- 20/12W, 40/22W
- Available in 610x160mm and 1200x160mm
- Tri colour in 3000K, 4000K and 5700K
- High efficacy up to 100lm/W
- Beam angle 120°
- IP20
- Polycarbonate housing
- Easy install thanks to 6mm terminal block
- Lifetime 30000 hours

AREAS OF APPLICATION

- Reception areas and foyers
- Garages
- Corridors, stairways, and entrance areas
- Entrances and hallways
- Retail and hospitality

AVAILABLE SIZES

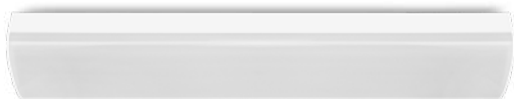

20/12W
610x160x62mm

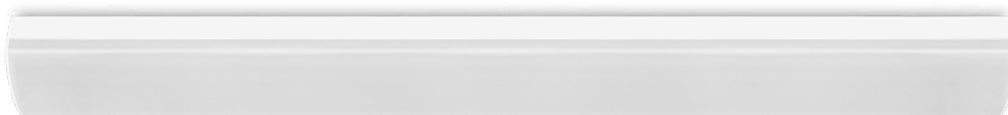

40/22W
1200x160x62mm

SPECIFICATIONS

Wattage	20/12W, 40/22W	Connection Type	Terminal block
Lumens	2200, 4400	PF	>0.9
lm/W	100	Frequency	50/60Hz
CCT	3000K/4000K/5700K	Mounting Type	Surface mounting
IP Rating	IP20	Operating Temperature	-20°C to 40°C
Housing Material	Polycarbonate	Lifetime	30000 hours
Beam Angle	120°	Warranty	5 years
CRI	>80		
SDCM	<6		
Electrical Classification	Class II		

PHOTOMETRICS

Example of LDVBAT12002240WTRI)

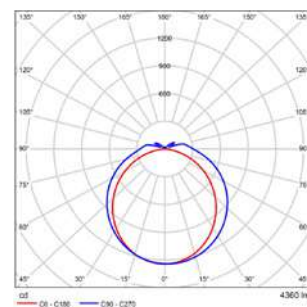

DIMENSIONS

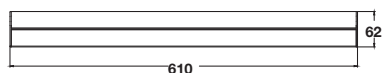
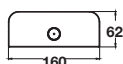
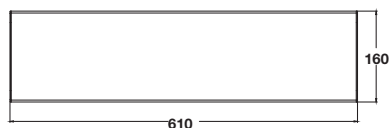

20/12W
610x160x62mm

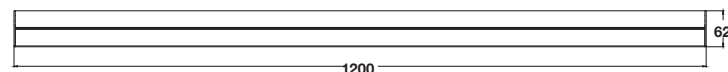
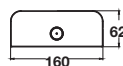
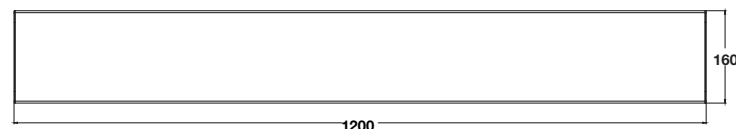

40/22W
1200x160x62mm

ORDERING CODES - TRI COLOUR MULTI WATTAGE BATTEN - WIDE



Product name	EAN10	Model number	W	lm	K		lm/W		L (mm)	w (mm)	h (mm)	
--------------	-------	--------------	---	----	---	--	------	--	--------	--------	--------	--

TRI COLOUR MULTI WATTAGE BATTEN - WIDE

LDV BAT 600 12/20WTRI WIDEG2 6X1AU LEDV	4058075616516	LDVBAT6001220WTRIWIDE	20/12	1100/ 2200	3000/ 4000/ 5700	120	90/ 100	×	610	160	62	880
LDV BAT 1200 22/40WTRIWIDEG2 6X1AU LEDV	4058075616530	LDVBAT12002240WTRIWIDE	40/22	2420/ 4400	3000/ 4000/ 5700	120	90/ 100	×	1200	160	62	1700

TRI COLOUR MULTI WATTAGE BATTEN - WIDE

TRI COLOUR MULTI WATTAGE BATTEN - WIDE



Blade Batten

The Blade Batten is an ultra slim, compact surface luminaire with a 31mm height. Designed with a tri colour switch to conveniently choose the most effective and appropriate light temperature according to the environment.

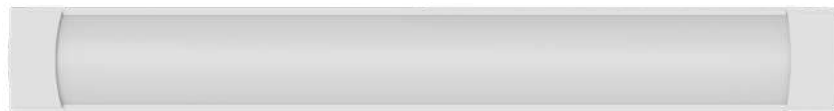

FEATURES AND BENEFITS

- 20W, 40W
- Available in 600mm and 1200mm
- Tri colour in 3000K, 4000K and 5000K
- High efficacy up to 100lm/W
- Beam angle 110°
- IP20
- Housing material polycarbonate
- Lifetime 15000 hours

AREAS OF APPLICATION

- Reception areas and foyers
- Garages
- Corridors, stairways, and entrance areas
- Entrances and hallways
- Retail and hospitality

AVAILABLE SIZES



20W
600x75x30.5mm



40W
1200x75x30.5mm

SPECIFICATIONS

Wattage	20W, 40W	Electrical Classification	Class II
Lumens	2000, 4000	PF	>0.9
lm/W	100	Frequency	50/60Hz
CCT	3000K/4000K/5000K	Mounting Type	Surface mounting
IP Rating	IP20	Operating Temperature	-20°C to 45°C
Housing Material	Polycarbonate	Lifetime	15000 hours
Beam Angle	110°	Warranty	5 years
CRI	>80		
SDCM	<6		

PHOTOMETRICS

(Example of LDVBAT120040WTRIECO)

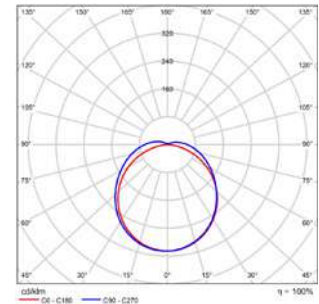

DIMENSIONS

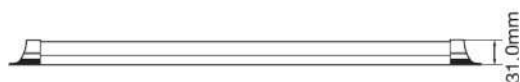
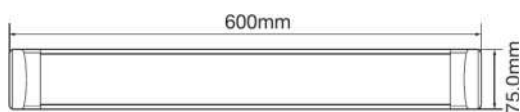

20W
600x75x30.5mm

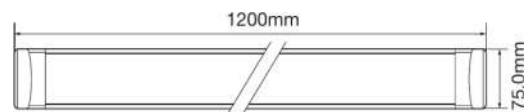

40W
1200x75Mx30.5mm

ORDERING CODES - BLADE BATTEN



Product name	EAN10	Model number	W	lm	K	°	lm/w	°	L (mm)	w (mm)	h (mm)	Person icon
--------------	-------	--------------	---	----	---	---	------	---	--------	--------	--------	-------------

BLADE BATTEN

LDECO BAT 600MM 20W TRI HOME 10X1AULEDV	4058075706552	LDVBAT60020WTRIECO	20	2000	3000/ 4000/ 5000	110	100	×	600	75	31	310
LDECO BAT 1200MM 40W TRI HOME10X1AULEDV	4058075706590	LDVBAT120040WTRIECO	40	4000	3000/ 4000/ 5000	110	100	×	1200	75	31	590

BLADE BATTEN



BLADE BATTEN

Linkable Batten

The Linkable Batten is a super slim, lightweight design with an integral driver. With a polycarbonate body and opal diffuser, this batten offers homogeneous light distribution with low power consumption. Perfect for applications within shops, shelving and under cabinets.



FEATURES AND BENEFITS

- 6.5W, 13W
- Available in 600mm and 1200mm
- Single colour in 4000K or 6500K
- High efficacy up to 100lm/W
- Beam angle 100°
- IP20
- Pre-wired with flex and plug
- Polycarbonate housing
- Lifetime 15000 hours

AREAS OF APPLICATION

- Reception areas and foyers
- Garages
- Corridors, stairways, and entrance areas
- Entrances and hallways
- Retail and hospitality

AVAILABLE SIZES



6.5W
580x20x31mm



13W
1180x20x31mm

SPECIFICATIONS

Wattage	6.5W, 13W	Connection Type	1.5m power cable, 265mm connection cable
Lumens	650, 1300		Max connections: 6.5W Batten 15 pcs, 13W Batten 8 pcs, or <104W mixed lengths
lm/W	100		
CCT	4000K, 6500K		
IP Rating	IP20		
Housing Material	Polycarbonate	PF	>0.5
Beam Angle	100°	Frequency	50/60Hz
CRI	>80	Mounting Type	Surface mounting
SDCM	<6	Operating Temperature	-10°C to 40°C
Electrical Classification	Class II	Lifetime	15000 hours
		Warranty	5 years

PHOTOMETRICS

(Example of LDWALBAT2FT840G4)

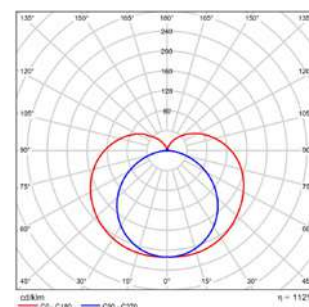

LINKABLE BATTEN

DIMENSIONS

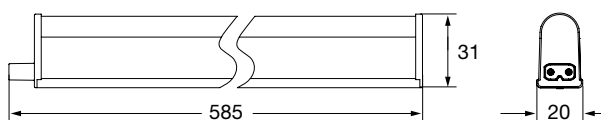

6.5W
580x20x31mm

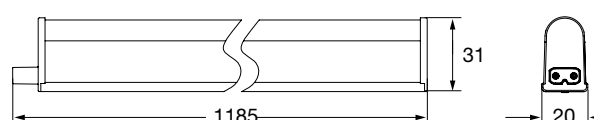

13W
1180x20x31mm

Power cable and connection cable included in package
 Length of power cable 1.5m
 Length of connection cable 265mm
 Max connections 6.5W - 15pcs, 13W - 8 pcs, or <104W mixed lengths

ORDERING CODES - LINKABLE BATTEN



Product name	EAN10	Model number	W	lm	K	°	lm/w	°	L (mm)	w (mm)	h (mm)	Person icon
--------------	-------	--------------	---	----	---	---	------	---	--------	--------	--------	-------------

LINKABLE BATTEN

LDVAL BAT 600 6.5W 4000K 30X1 G4AU LEDV	4099854114991	LDWALBAT2FT840G4	6.5	650	4000	120	100	×	585	20	31	150
LDVAL BAT 600 6.5W 6500K 30X1 G4AU LEDV	4099854115011	LDWALBAT2FT865G4	6.5	650	6500	120	100	×	585	20	31	150
LDVAL BAT 1200 13W 4000K 30X1 G4AU LEDV	4099854115059	LDWALBAT4FT840G4	13	1300	4000	120	100	×	1185	20	31	290
LDVAL BAT 1200 13W 6500K 30X1 G4AU LEDV	4099854115073	LDWALBAT4FT865G4	13	1300	6500	120	100	×	1185	20	31	290

LINKABLE BATTEN



LINKABLE BATTEN

Mini Batten

The Mini Batten is a versatile lighting solution that is available in two wattage options and features dual colour options in 4000K and 6500K, allowing users to choose the most suitable lighting for their needs. The high efficacy of up to 100 lm/W ensures that it provides bright and efficient lighting. It is also IP44 rated and IK05 impact resistant, ensuring durability and safety. It has a lifetime of 25000 hours, making it an excellent investment for any lighting project.



FEATURES AND BENEFITS

- Two power levels: 10/15W or 15/20W
- Available in 600mm and 900mm
- Dual colour in 4000K and 6500K via DIP switch
- High efficacy up to 100 lm/W
- Beam angle 120°
- IP44
- IK05
- Polycarbonate housing
- Lifetime 25000 hours

AREAS OF APPLICATION

- Kitchens and bathrooms
- Reception areas and foyers
- Corridors, stairways, and entrance areas
- Bedrooms
- Dormitories

AVAILABLE SIZES



10/15W
596x61x71mm



15/20W
896x61x71mm

SPECIFICATIONS

Wattage	10/15W, 15/20W	Connection Type	Terminal block
Lumens	1500, 2000	Voltage	220-240V AC
lm/W	100	PF	0.7
CCT	4000/6500K	Frequency	50/60Hz
IP Rating	IP44	Mounting Type	Surface mounting
IK Rating	IK05	Operating Temperature	-20°C to 40°C
Housing Material	Polycarbonate	Lifetime	25000 hours
Beam Angle	120°	Warranty	5 years
CRI	>80		
SDCM	<6		
Electrical Classification	Class II		

PHOTOMETRICS

(Example of LDVBAT90020W840/65)

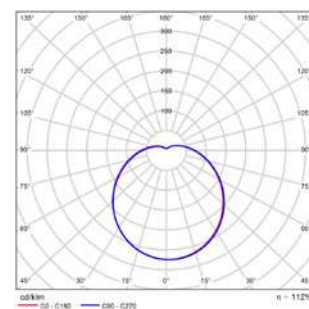

MINI BATTEN

DIMENSIONS

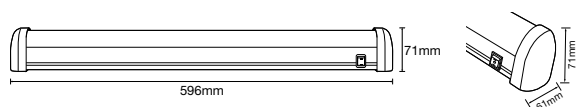

10/15W
596x61x71mm

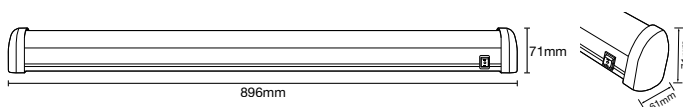

15/20W
896x61x71mm

ORDERING CODES - MINI BATTEN



Product name	EAN10	Model number	W	lm	K	Δ°	lm/w	\curvearrowright	L (mm)	w (mm)	h (mm)	
--------------	-------	--------------	---	----	---	----------------	------	--------------------	--------	--------	--------	--

MINI BATTEN

LDVAL BAT600 10/15W 840/865 IP44 15X1AULEDV	4099854201806	LDVBAT60015W840/65	10/ 15	1000/ 1500	4000/ 6500	120	100	✘	596	61	71	398
LDVAL BAT900 15/20W 840/865 IP44 12X1AULEDV	4099854201837	LDVBAT90020W840/65	15/ 20	1500/ 2000	4000/ 6500	120	100	✘	896	61	71	532

MINI BATTEN



MINI BATTEN



WEATHERPROOF

Applications: Car parks | Underpasses | Garages | Industrial | Storage facilities



WIDE WEATHERPROOF BATTEN

90

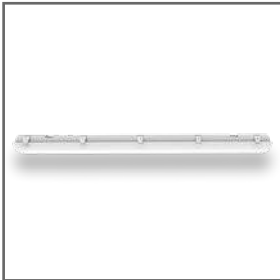

**TRI COLOUR MULTI WATTAGE
WEATHERPROOF BATTEN**

94

Wide Weatherproof Batten

Wide Weatherproof Batten available in multiple sizes, wattages and functions, making it the perfect LED solution for replacement of traditional fluorescent weatherproof luminaires.

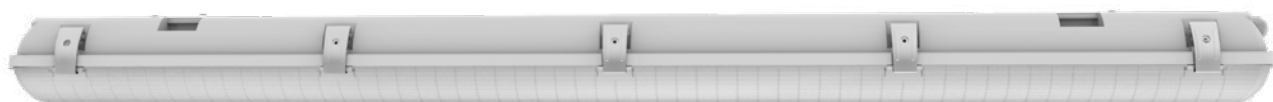

FEATURES AND BENEFITS

- 20W, 40W, 50W
- Available in 600mm, 1200mm and 1500mm
- Wide body with 130mm width
- Single colour in 4000K or 6500K
- High efficacy up to 100lm/W
- DALI, emergency and sensor options available
- Beam angle 115°
- IP65 for damp and wet applications
- IK08 for vandal resistance
- Polycarbonate housing
- Lifetime 50000 hours

AREAS OF APPLICATION

- Car parks
- Storage facilities
- Outdoor areas
- Passages and underpasses
- Workshops and assembly lines

AVAILABLE SIZES



600x130x92mm

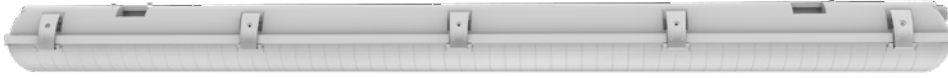

1200x130x92mm



1500x130x 92mm

SPECIFICATIONS

Wattage	20W, 40W, 50W	Beam Angle	115°
Lumens	2000, 4000, 5000	CRI	>80
lm/W	100	SDCM	<6
CCT	4000K, 6500K	Electrical Classification	Class II
IP Rating	IP65	Connection Type	6mm terminal block
IK Rating	IK08	PF	>0.9
Dimmable	DALI option available	Frequency	50/60Hz
Sensor	Sensor optional available	Mounting Type	Surface mounting
Emergency Battery	LiFePO4	Operating Temperature	-20°C to 40°C
Housing Material	Body: Polycarbonate Clips and mounting brackets: Stainless steel 301	Lifetime	50000 hours
		Warranty	5 years

PHOTOMETRICS

(Example of LDVWP120013040W840)

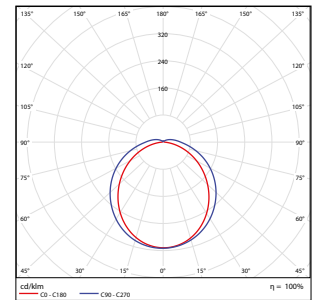

DIMENSIONS

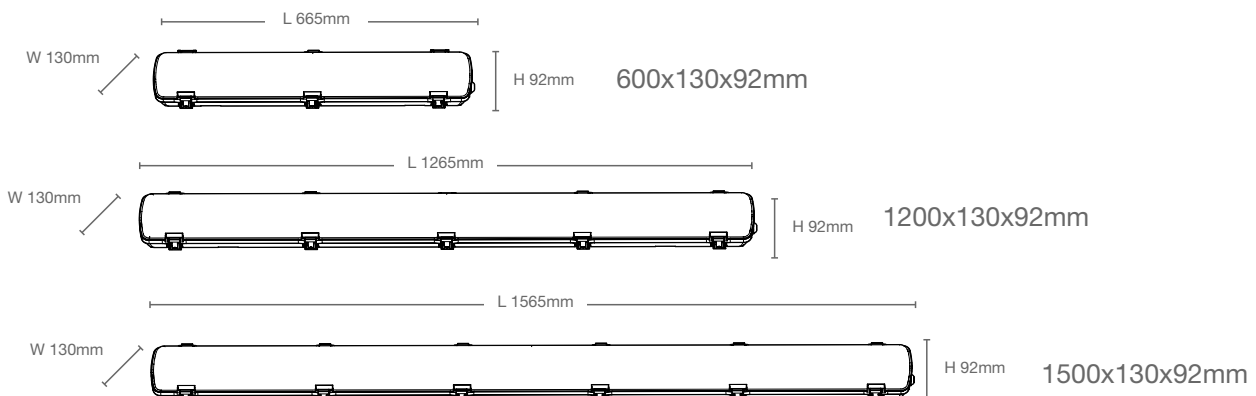

ORDERING CODES - WIDE WEATHERPROOF BATTEN



Product name	EAN10	Model number	W	lm	K	Δ	lm/W	\curvearrowright	L (mm)	w (mm)	h (mm)	
--------------	-------	--------------	---	----	---	----------	------	--------------------	--------	--------	--------	--

STANDARD

LDVAL WP 600 IP65 W 20W 840 6X1 LEDV	4058075394841	LDVWP60013020W840	20	2000	4000	115	100	×	655	130	92	1280
LDVAL WP 600 IP65 W 20W 865 6X1 AU LEDV	4058075476875	LDVWP60013020W865	20	2000	6500	115	100	×	655	130	92	1280
LDVAL WP 1200 IP65 W 20W 840 6X1 LEDV	4058075394865	LDVWP120013020W840	20	2000	4000	115	100	×	1265	130	92	1970
LDVAL WP 1200 IP65 W 20W 865 6X1 AU LEDV	4058075476899	LDVWP120013020W865	20	2000	6500	115	100	×	1265	130	92	1970
LDVAL WP 1200 IP65 W 40W 840 6X1 LEDV	4058075388321	LDVWP120013040W840	40	4000	4000	115	100	×	1265	130	92	1970
LDVAL WP 1200 IP65 W 40W 865 6X1 AU LEDV	4058075476912	LDV120013040W865	40	4000	6500	115	100	×	1265	130	92	1970
LDVAL WP 1500 IP65 W 50W 840 4X1 LEDV	4058075394964	LDVWP150013050W840	50	5000	4000	115	100	×	1565	130	92	2680
LDVAL WP 1500 IP65 W 50W 865 4X1 AU LEDV	4058075476936	LDVWP150013050W865	50	5000	6500	115	100	×	1565	130	92	2680



Product name	EAN10	Model number	W	lm	K	Δ	lm/W	\curvearrowright	L (mm)	w (mm)	h (mm)	
--------------	-------	--------------	---	----	---	----------	------	--------------------	--------	--------	--------	--

MICROWAVE SENSOR

LDVAL WP 1200 IP65 W 20W 840 MS 6X1 LEDV	4058075394988	LDVWP120013020W840MS	20	2000	4000	115	100	×	1265	130	92	2000
LDVAL WP 1200 IP65 W 20W 865MS6X1AU LEDV	4058075481657	LDVWP120013020W865MS	20	2000	6500	115	100	×	1265	130	92	2000
LDVAL WP 1200 IP65 W 40W 840 MS 6X1 LEDV	4058075395008	LDVWP120013040W840MS	40	4000	4000	115	100	×	1265	130	92	2000
LDVAL WP 1200 IP65 W 40W 865MS6X1AU LEDV	4058075481671	LDVWP120013040W865MS	40	4000	6500	115	100	×	1265	130	92	2000
LDVAL WP 1500 IP65 W 50W 840 MS 4X1 LEDV	4058075395022	LDVWP150013050W840MS	50	5000	4000	115	100	×	1565	130	92	2730
LDVAL WP 1500 IP65 W 50W 865MS4X1AU LEDV	4058075481695	LDVWP150013050W865MS	50	5000	6500	115	100	×	1565	130	92	2730

ORDERING CODES - WIDE WEATHERPROOF BATTEN



Product name	EAN10	Model number	W	lm	K	°	lm/W	°	l [mm]	w [mm]	h [mm]	g
--------------	-------	--------------	---	----	---	---	------	---	--------	--------	--------	---

DALI

LDVAL WP 600 IP65 W 20W 840 D 6X1 LEDV	4058075394902	LDVWP60013020W840D	20	2000	4000	115	100	✓	655	130	92	1280
LDVAL WP 600 IP65 W 20W 865 D 6X1AULEDV	4058075477018	LDVWP60013020W865D	20	2000	6500	115	100	✓	655	130	92	1280
LDVAL WP 1200 IP65 W 20W 840 D 6X1 LEDV	4058075394926	LDVWP120013020W840D	20	2000	4000	115	100	✓	1265	130	92	1970
LDVAL WP 1200 IP65 W 20W 865 D6X1AULEDV	4058075481589	LDVWP120013020W865D	20	2000	6500	115	100	✓	1265	130	92	1970
LDVAL WP 1200 IP65 W 40W 840 D 6X1 LEDV	4058075394940	LDVWP120013040W840D	40	4000	4000	115	100	✓	1265	130	92	1970
LDVAL WP 1200 IP65 W 40W 865 D6X1AULEDV	4058075481619	LDVWP120013040W865D	40	4000	6500	115	100	✓	1265	130	92	1970
LDVAL WP 1500 IP65 W 50W 840 D 4X1 LEDV	4058075394964	LDVWP150013050W840D	50	5000	4000	115	100	✓	1565	130	92	2680
LDVAL WP 1500 IP65 W 50W 865 D4X1AULEDV	4058075481633	LDVWP150013050W865D	50	5000	6500	115	100	✓	1565	130	92	2680



Product name	EAN10	Model number	W	lm	K	°	lm/W	°	l [mm]	w [mm]	h [mm]	g	EMERGENCY BATTERY
--------------	-------	--------------	---	----	---	---	------	---	--------	--------	--------	---	-------------------

EMERGENCY

LDVAL WP 1200 IP65 W 22W 840 EM 4X1 LEDV	4058075396562	LDVWP120013022W840EM	22	2000	4000	115	100	×	1265	130	92	2280	180
LDVAL WP 1200 IP65 W 22W 865EM6X1AULEDV	4058075476950	LDVWP120013022W865EM	22	2000	6500	115	100	×	1265	130	92	2280	180
LDVAL WP 1200 IP65 W 42W 840 EM 4X1 LEDV	4058075396586	LDVWP120013042W840EM	42	4000	4000	115	100	×	1265	130	92	2280	180
LDVAL WP 1200 IP65 W 42W 865EM6X1AULEDV	4058075476974	LDVWP120013042W865EM	42	4000	6500	115	100	×	1265	130	92	2280	180
LDVAL WP 1500 IP65 W 52W 840 EM 4X1 LEDV	4058075396609	LDVWP150013052W840EM	52	5000	4000	115	100	×	1565	130	92	3020	180
LDVAL WP 1500 IP65 W 52W 865EM4X1AULEDV	4058075476998	LDVWP150013052W865EM	52	5000	4000	115	100	×	1565	130	92	3020	180

*5 years (1 year on emergency battery)

Tri Colour Multi Wattage Weatherproof Batten

Tri Colour Multi Wattage Weatherproof Batten available in a wide range of sizes, wattages and functions, making it the perfect LED solution for replacement of traditional fluorescent weatherproof luminaires. These weatherproof battens come with both wattage switch and tri colour for ultimate versatility and minimise stock holdings.



FEATURES AND BENEFITS

- Standard and microwave sensor version: 10/13/15/20W, 20/27/33/40W, 25/34/42/50W, Emergency version: 14/17/19/24W, 24/30/36/42W, 29/37/46/53W
- Available in 600mm, 1200mm and 1500mm
- Tri colour in 3000K, 4000K and 6500K
- High efficacy up to 120lm/W
- Beam angle 120°
- IP65
- IK08
- Polycarbonate housing
- Lifetime 50000 hours

AREAS OF APPLICATION

- Car parks
- Storage facilities
- Outdoor areas
- Passages and underpasses
- Workshops and assembly lines

AVAILABLE SIZES



600x115x86mm



1200x115x86mm



1500x115x86mm

SPECIFICATIONS

Wattage	Standard version: 10/13/15/20W, 20/27/33/40W, 25/34/42/50W,	Housing Material	Body: Polycarbonate Clips and mounting brackets: Stainless steel 301
	Emergency version: 14/17/19/24W, 24/30/36/42W, 29/37/46/53W		
Lumens	1200/1600/1800/2400 2900/3600/4350/5050 3500/4450/5550/6350	Beam Angle	120°
		CRI	>80
lm/W	120	SDCM	<5
CCT	3000/4000/6500K	Electrical Classification	Class I
IP Rating	IP65	PF	>0.9
IK Rating	IK08	Frequency	50/60Hz
Sensor	Microwave sensor	Mounting Type	Surface mounting
Emergency Battery	LiFePO4	Operating Temperature	-20°C to 40°C
Emergency Duration	180 minutes	Lifetime	50000 hours
		Warranty	5 years

PHOTOMETRICS

(Example of LDVWP120024/42WTRIEMMS)

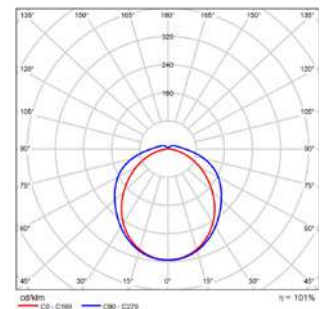

DIMENSIONS

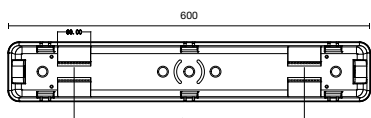

600x115x86mm

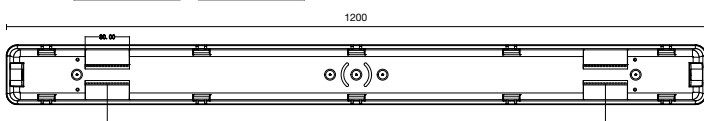

1200x115x86mm

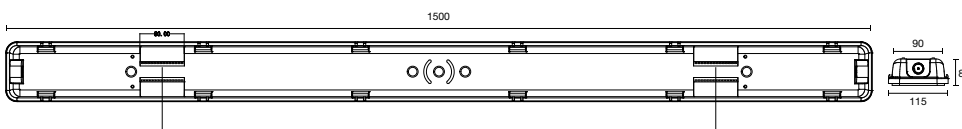

1500x115x86mm

ORDERING CODES - TRI COLOUR MULTI WATTAGE WEATHERPROOF BATTEN

VALUE CLASS

Product name	EAN10	Model number	W	lm	K	°	lm/w	°	l [mm]	w [mm]	h [mm]	g
--------------	-------	--------------	---	----	---	---	------	---	--------	--------	--------	---

STANDARD

LDVAL WP 600 10/20W TRI 6X1 AU LEDV	4099854212574	LDVWP60010/20WTRI	10/ 13/ 15/ 20	1200/ 1600/ 1800/ 2400	3000/ 4000/ 6500	120	120	WATTAGE SWITCH	600	115	86	1005
LDVAL WP 1200 20/40W TRI 6X1 AU LEDV	4099854212659	LDVWP120020/40WTRI	20/ 27/ 33/ 40	2400/ 3250/ 4000/ 4800	3000/ 4000/ 6500	120	120	WATTAGE SWITCH	1200	115	86	1880
LDVAL WP 1500 25/50W TRI 6X1 AU LEDV	4099854212734	LDVWP150025/50WTRI	25/ 34/ 42/ 50	3000/ 4100/ 5050/ 6000	3000/ 4000/ 6500	120	120	WATTAGE SWITCH	1500	115	86	2140

VALUE CLASS

Product name	EAN10	Model number	W	lm	K	°	lm/w	°	l [mm]	w [mm]	h [mm]	g
--------------	-------	--------------	---	----	---	---	------	---	--------	--------	--------	---

MICROWAVE SENSOR

LDVAL WP 600 10/20W TRI MS 6X1 AU LEDV	4099854212598	LDVWP60010/20WTRIMS	10/ 13/ 15/ 20	1200/ 1600/ 1800/ 2400	3000/ 4000/ 6500	120	120	WATTAGE SWITCH	600	115	86	1060
LDVAL WP 1200 20/40W TRI MS 6X1 AU LEDV	4099854212673	LDVWP120020/40WTRIMS	20/ 27/ 33/ 40	2400/ 3250/ 4000/ 4800	3000/ 4000/ 6500	120	120	WATTAGE SWITCH	1200	115	86	1940
LDVAL WP 1500 25/50W TRI MS 6X1 AU LEDV	4099854212758	LDVWP150025/50WTRIMS	25/ 34/ 42/ 50	3000/ 4100/ 5050/ 6000	3000/ 4000/ 6500	120	120	WATTAGE SWITCH	1500	115	86	2190

TRI COLOUR MULTI WATTAGE WEATHERPROOF BATTEN

ORDERING CODES - TRI COLOUR MULTI WATTAGE WEATHERPROOF BATTEN











Product name **EAN10** **Model number**











EMERGENCY

LDVAL WP 600 14/24W TRI EM 6X1 AU LEDV	4099854212611	LDWWP60014/24WTRIEM	14/ 17/ 19/ 24	1200/ 1600/ 1800/ 2400	3000/ 4000/ 6500	120	120	WATTAGE SWITCH	600	115	86	1300	180
LDVAL WP 1200 24/42W TRI EM 6X1 AU LEDV	4099854212697	LDWWP120024/42WTRIEM	24/ 30/ 36/ 42	2900/ 3600/ 4350/ 5050	3000/ 4000/ 6500	120	120	WATTAGE SWITCH	1200	115	86	2160	180
LDVAL WP 1500 29/53W TRI EM 6X1 AU LEDV	4099854212772	LDWWP150029/53WTRIEM	29/ 37/ 46/ 53	3500/ 4450/ 5550/ 6350	3000/ 4000/ 6500	120	120	WATTAGE SWITCH	1500	115	86	2430	180











Product name **EAN10** **Model number**











EMERGENCY AND MICROWAVE SENSOR

LDVAL WP 600 14/24W TRI EM MS 6X1 AU LEDV	4099854212635	LDWWP60014/24WTRIEMMS	14/ 17/ 19/ 24	1200/ 1600/ 1800/ 2400	3000/ 4000/ 6500	120	120	WATTAGE SWITCH	600	115	86	1350	180
LDVAL WP 1200 24/42W TRI EM MS 6X1 AU LEDV	4099854212710	LDWWP120024/42WTRIEMMS	24/ 30/ 36/ 42	2900/ 3600/ 4350/ 5050	3000/ 4000/ 6500	120	120	WATTAGE SWITCH	1200	115	86	2210	180
LDVAL WP1500 29/53W TRI EM MS 6X1 AU LEDV	4099854212796	LDWWP150029/53WTRIEMMS	29/ 37/ 46/ 53	3500/ 4450/ 5550/ 6350	3000/ 4000/ 6500	120	120	WATTAGE SWITCH	1500	115	86	2480	180

*5 years (1 year on emergency battery)

TRI COLOUR MULTI WATTAGE WEATHERPROOF BATTEN



HIGHBAY AND CANOPY LIGHT

Applications: Public areas | Warehouses | Industrial | Building facade | Construction areas



TRI COLOUR MULTI WATTAGE HIGHBAY

100



PERFORMANCE HIGHBAY

106



CANOPY LIGHT

110

Tri Colour Multi Wattage Highbay

Tri Colour Multi Wattage Highbay is a reliable and efficient luminaire, offering three colour temperatures and three power setting in one fitting, with a high lumen output up to 140 lm/W. Available with 1-10V dimming, DALI and sensor options.



FEATURES AND BENEFITS

- 60/80/100W, 125/150/200W
- Tri colour in 4000K, 5000K, and 6500K
- High efficacy up to 140 lm/W
- 10-10V or DALI dimming
- Beam angle 90°
- IP65
- IK08
- Pre-wired with 1.5m flex and plug
- Aluminium housing
- Lifetime 50000 hours

AREAS OF APPLICATION

- Warehouses
- Construction areas
- Storage facilities
- Workshops and assembly lines
- Canopies

AVAILABLE SIZES



60W/80W/100W
Ø280x166mm



125W/150W/200W
Ø343x166mm

ACCESSORIES (SOLD SEPARATELY)



PC Reflector



Aluminium Reflector



Microwave Sensor



Remote Controller



Surface Mount Bracket



Wire Guard

SPECIFICATIONS

Wattage	60/80/100W, 125/150/200W	SDCM	<5
Lumens	14000, 28000	Electrical Classification	Class I
lm/W	140	Connection Type	1.5m flex and plug
CCT	4000K/5000K/6500K	Voltage	100-277V
IP Rating	IP65	PF	>0.9
IK Rating	IK08	Frequency	50/60Hz
Dimmable	1-10V, DALI	Mounting Type	Suspension Surface mounting
Sensor	Microwave sensor (optional)	Operating Temperature	-30°C to 50°C
Housing Material	Aluminium	Lifetime	50000 hours
Beam Angle	90°	Warranty	5 years
CRI	>80		

PHOTOMETRICS

(Example of LDVHB60-100WTRI)

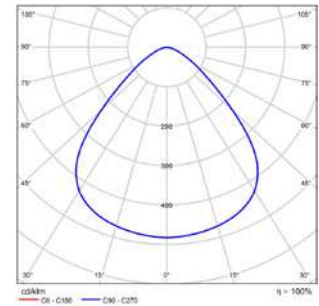

(Example of LDVHB125-200WTRI)

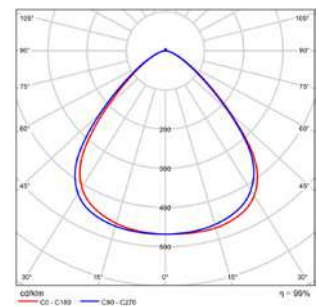

DIMENSIONS

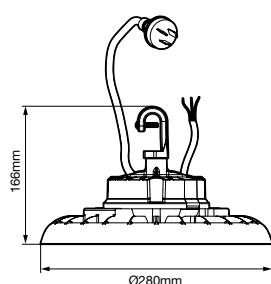
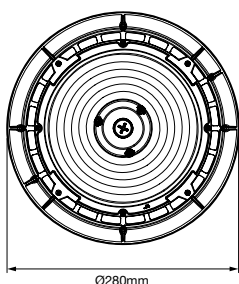

60W/80W/100W
Ø280x166mm

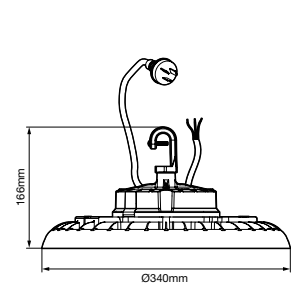
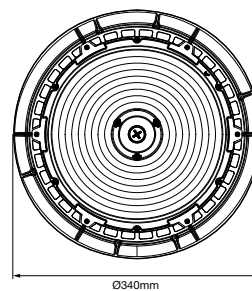

125W/150W/200W
Ø343x166mm

ORDERING CODES - TRI COLOUR MULTI WATTAGE HIGHBAY



Product name	EAN10	Model number	W	lm	K	°	lm/W	∅ (mm)	h (mm)	Person icon
--------------	-------	--------------	---	----	---	---	------	--------	--------	-------------

STANDARD

LDP HB TRI 60/80/100W VS1 AU LEDV	4099854115622	LDVHB60-100WTRI	100/ 80/ 60	14000/ 11500/ 9000	4000/ 5000 6500	90	140- 150	280	166	2235
LDP HB TRI 125/150/200W VS1 AU LEDV	4099854115615	LDVHB125-200WTRI	200/ 150/ 125	28000/ 22500/ 19000	4000/ 5000 6500	90	140- 152	343	166	3135



Product name	EAN10	Model number	W	lm	K	°	lm/W	∅ (mm)	h (mm)	Person icon
--------------	-------	--------------	---	----	---	---	------	--------	--------	-------------

DALI*

LDP HB TRI DA 60/80/100W WV VS1 AU LEDV	4099854115677	LDVHB60-100WTRIDALI	100/ 80/ 60	14000/ 11500/ 9000	4000/ 5000 6500	90	140- 152	280	166	2235
LDP HB TRI DA 125/150/200W WV VS1 AU LEDV	4099854115660	LDVHB125-200WTRIDALI	200/ 150/ 125	28000/ 22500/ 19000	4000/ 5000 6500	90	140- 152	343	166	3135

*Sensor not available for DALI version.

ORDERING CODES - TRI COLOUR MULTI WATTAGE HIGHBAY



Product name	EAN10	Model number				
--------------	-------	--------------	---	---	---	---

PC REFLECTOR



LDP HB TRI PC REFLECTOR 100W VS10 LEDV	4099854117978	LDVHBRPC100W	411	411	160	530
LDP HB TRI PC REFLECTOR 200W VS10 LEDV	4099854117916	LDVHBRPC200W	411	411	160	580

ALUMINIUM REFLECTOR



(UGR<22 when installed with aluminium reflector)

LDP HB TRI ALU REFLECTOR 100W VS10 LEDV	4099854118173	LDVHBRALU100W	413	413	164	400
LDP HB TRI ALU REFLECTOR 200W VS10 LEDV	4099854118135	LDVHBRALU200W	412	412	164	500

MICROWAVE SENSOR



LDP HB TRI SENSOR 50X1 LEDV	4099854118197	LDVHBTMS	56	56	38	30
-----------------------------	---------------	----------	----	----	----	----

REMOTE CONTROLLER



LDP HB TRI REMOTE 50X1 LEDV	4099854118234	LDVHBMRS	140	50	10	52
-----------------------------	---------------	----------	-----	----	----	----

SURFACE MOUNT BRACKET



LDP HB TRI BRACKET 100W 20X1 LEDV	4099854118272	LDVHBBKT100W	207	67	150	500
LDP HB TRI BRACKET 200W 20X1 LEDV	4099854118258	LDBHBBKT200W	256	67	170	600

WIRE GUARD



LDPFM HB TRICCT 100 WIREGUARD 20X1 LEDV	4099854300462	LDVHBWG100WTRI	261	261	48	11
LDPFM HB TRICCT 200 WIREGUARD 20X1 LEDV	4099854300486	LDVHBWG200WTRI	315	315	53	14

REFERENCE GUIDE- TRI COLOUR MULTI WATTAGE HIGHBAY

Recommended Light Levels (AS1680)				
Fine Machine Work/ Inspection or Finishing	Medium to Fine Processing/ Manufacturing	Medium Processing/ Manufacturing	Rough Machine Work/ Fabrication	Bulk Storage/ Warehousing
600+ LX	400-600 LX	240-400 LX	160-240 LX	80-160 LX

Mounting Height

Height of highbay measured from the ground

		4M	6M	8M	10M	12M	14M	16M	
		LDVHB60-100WTRI (4099854115622) set to 60W							
Spacing Distance between highbays	4M	440 LX	419 LX	402 LX	385 LX	369 LX	353 LX	337 LX	
	6M	215 LX	202 LX	193 LX	184 LX	177 LX	169 LX	162 LX	
	8M	122 LX	113 LX	106 LX	101 LX	96 LX	92 LX	88 LX	
	10M	80 LX							
			LDVHB60-100WTRI (4099854115622) set to 80W						
	4M	562 LX	536 LX	513 LX	492 LX	471 LX	451 LX	430 LX	
	6M	274 LX	258 LX	246 LX	236 LX	226 LX	216 LX	207 LX	
	8M	156 LX	144 LX	135 LX	129 LX	123 LX	118 LX	112 LX	
	10M	102 LX	95 LX	89 LX	84 LX	80 LX			
			LDVHB60-100WTRI (4099854115622) set to 100W						
4M	685 LX	653 LX	625 LX	599 LX	574 LX	549 LX	524 LX		
6M	334 LX	314 LX	300 LX	287 LX	275 LX	263 LX	252 LX		
8M	190 LX	175 LX	165 LX	157 LX	150 LX	144 LX	137 LX		
10M	124 LX	116 LX	108 LX	102 LX	97 LX	92 LX	88 LX		
12M	98 LX	96 LX	90 LX	85 LX	82 LX	80 LX			

This is a guide only. A lighting design should be completed for an accurate lux level. Please contact your LEDVANCE Salesperson for further information.

REFERENCE GUIDE- TRI COLOUR MULTI WATTAGE HIGHBAY

Recommended Light Levels (AS1680)				
Fine Machine Work/ Inspection or Finishing	Medium to Fine Processing/ Manufacturing	Medium Processing/ Manufacturing	Rough Machine Work/ Fabrication	Bulk Storage/ Warehousing
600+ LX	400-600 LX	240-400 LX	160-240 LX	80-160 LX

Mounting Height

Height of highbay measured from the ground

Spacing Distance between highbays	Mounting Height						
	4M	6M	8M	10M	12M	14M	16M
LDVHB125-200WTRI (4099854115615) set to 125W							
4M	913 LX	869 LX	832 LX	799 LX	765 LX	732 LX	699 LX
6M	446 LX	419 LX	400 LX	383 LX	367 LX	351 LX	336 LX
8M	253 LX	234 LX	220 LX	210 LX	201 LX	192 LX	183 LX
10M	165 LX	154 LX	144 LX	136 LX	130 LX	124 LX	118 LX
12M	130 LX	127 LX	120 LX	114 LX	109 LX	105 LX	101 LX
14M	94 LX	89 LX	82 LX				
LDVHB125-200WTRI (4099854115615) set to 150W							
4M	1088 LX	1036 LX	992 LX	952 LX	912 LX	873 LX	833 LX
6M	531 LX	499 LX	476 LX	456 LX	437 LX	419 LX	400 LX
8M	302 LX	279 LX	262 LX	250 LX	239 LX	228 LX	218 LX
10M	197 LX	184 LX	172 LX	162 LX	154 LX	147 LX	140 LX
12M	155 LX	152 LX	143 LX	136 LX	131 LX	126 LX	121 LX
14M	112 LX	106 LX	98 LX	92 LX	84 LX	80 LX	
LDVHB125-200WTRI (4099854115615) set to 200W							
4M	1343 LX	1279 LX	1226 LX	1176 LX	1127 LX	1078 LX	1029 LX
6M	656 LX	616 LX	588 LX	563 LX	540 LX	517 LX	494 LX
8M	373 LX	345 LX	324 LX	309 LX	295 LX	282 LX	269 LX
10M	244 LX	228 LX	212 LX	201 LX	191 LX	182 LX	173 LX
12M	192 LX	188 LX	176 LX	168 LX	161 LX	155 LX	149 LX
14M	138 LX	131 LX	121 LX	113 LX	104 LX	98 LX	94 LX
16M	132 LX	116 LX	107 LX	100 LX	94 LX	90 LX	86 LX
18M	98 LX	99 LX	91 LX	86 LX	82 LX		

TRI COLOUR MULTI WATTAGE HIGHBAY

This is a guide only. A lighting design should be completed for an accurate lux level. Please contact your LEDVANCE Salesperson for further information.

Performance Highbay

Performance Highbay is a reliable and high efficiency fitting with aluminium die-cast housing for both industry and commercial applications. The range is available in 2 housing sizes for 4 different wattages to meet the majority of application requirements. The motion sensor compatibility offers additional energy saving. It's an ideal solution for either retrofit or new construction.



FEATURES AND BENEFITS

- 90W, 120W, 150W, 200W
- Single colour in 4000K or 6500K
- High efficacy up to 140 lm/W
- 1-10V dimming
- Beam angle 90°
- IP65
- IK08
- Polycarbonate housing
- Lifetime 50000 hours

AREAS OF APPLICATION

- Warehouses
- Construction areas
- Storage facilities
- Workshops and assembly lines
- Canopies

AVAILABLE SIZES



90W & 120W
Ø280x110.2mm



150W
Ø321x107.2mm



200W
Ø320x121.3mm

ACCESSORIES (SOLD SEPARATELY)



Microwave
Sensor



Remote
Controller



Surface Mount Bracket

SPECIFICATIONS

Wattage	90W, 120W, 150W, 200W	Beam Angle	90°
Lumens	12600, 16800, 21000, 28000	CRI	>80
lm/W	140	Electrical Classification	Class I
CCT	4000K, 6500K	PF	>0.9
IP Rating	IP65	Voltage	100-277V
IK Rating	IK08	Frequency	50/60Hz
Dimmable	1-10V	Mounting Type	Suspension Surface mounting
Sensor	Microwave sensor (optional)	Operating Temperature	-30°C to 50°C
Housing Material	Polycarbonate	Lifetime	50000 hours
		Warranty	5 years

PHOTOMETRICS

(Example of LDVHBPRO150W865)

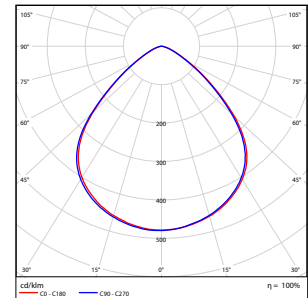

DIMENSIONS

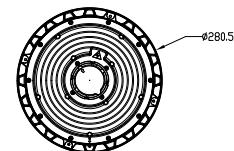
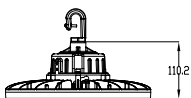

90W & 110W
Ø280x110.2mm

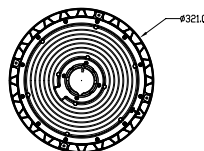
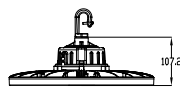

150W
Ø321x107.2mm

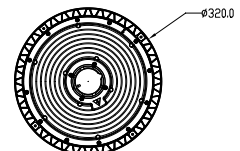
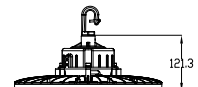

200W
Ø320x121.3mm

ORDERING CODES - PERFORMANCE HIGHBAY

PERFORMANCE CLASS



Product name

EAN10

Model number



PERFORMANCE HIGHBAY

LDPFM HB SC 90W 840 277V VS1 AU LEDV	4058075464643	LDVHBPRO90WFP840	90	12600	4000	90	140	280.5	110.2	2050
LDPFM HB SC 90W 865 277V VS1 AU LEDV	4058075464568	LDVHBPRO90WFP865	90	12600	6500	90	140	280.5	110.2	2050
LDPFM HB SC 120W 840 277V VS1 AU LEDV	4058075464650	LDVHBPRO120WFP840	120	16800	4000	90	140	280.5	110.2	2050
LDPFM HB SC 120W 865 277V VS1 AU LEDV	4058075464575	LDVHBPRO120WFP865	120	16800	6500	90	140	280.5	110.2	2050
LDPFM HB SC 150W 840 277V VS1 AU LEDV	4058075464667	LDVHBPRO150WFP840	150	21000	4000	90	140	321	107.2	2300
LDPFM HB SC 150W 865 277V VS1 AU LEDV	4058075464629	LDVHBPRO150WFP865	150	21000	6500	90	140	321	107.2	2300
LDPFM HB SC 200W 840 277V VS1 AU LEDV	4058075464674	LDVHBPRO200WFP840	200	28000	4000	90	140	321	121.2	2900
LDPFM HB SC 200W 865 277V VS1 AU LEDV	4058075464636	LDVHBPRO200WFP865	200	28000	6500	90	140	321	121.2	2900



Product name

EAN10

Model number



MICROWAVE SENSOR



LDPFM HBMS 60X1 EN LEDV	4058075464728	LDVHBMS	56.4	56.4	48.5
-------------------------	----------------------	---------	------	------	------

REMOTE CONTROL



LDPFM HBRC 60X1 EN LEDV	4058075464742	LDVHBRC	116	54.8	15
-------------------------	----------------------	---------	-----	------	----

MOUNTING BRACKET



LDPFM HB BRACKET KIT 90/120W/150W 10X1 EN LEDV	4058075443136	LDVHBBKT90150W	122	150	35
LDPFM HB BRACKET KIT 200W 10X1 EN LEDV	4058075443150	LDVHBBKT200W	138	150	35



PERFORMANCE HIGHBAY

Canopy Light

Canopy Light is a high efficient and reliable LED luminaire, designed for canopies and low/high bay applications. Robust die cast aluminium housing provides good heat dissipation. Two kinds of mounting types meet different installation applications.

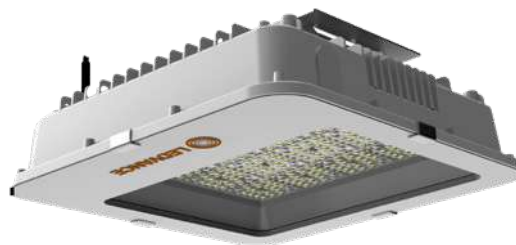

FEATURES AND BENEFITS

- 60W, 90W, 110W
- Surface mounting and recessed mounting options
- Single colour in 4000K
- High efficacy up to 135 lm/W
- Beam angle 120°
- IP65
- IK07
- Pre-wired with mains cable
- Aluminium housing with tempered glass cover
- Lifetime 50000 hours

AREAS OF APPLICATION

- Sheltered outdoor areas
- Indoor low/high space ceiling applications
- Logistics warehouse
- Canopy lighting

AVAILABLE SIZES



Surface mounting
60W, 90W, 110W
302x302x93mm



Recessed mounting
60W, 90W, 110W
400x400x90mm

SPECIFICATIONS

Wattage	60W, 90W, 110W	Voltage	220-240V AC
Lumens	8100, 12150, 14850	Input Current	75A@230V
lm/W	135	PF	0.95
CCT	4000K	Frequency	50/60Hz
IP Rating	IP66	Surge Protection	2KV (L-N), 4KV (L/N-PE)
IK Rating	IK07	Mounting Type	Surface mounting, Recessed mounting
Housing Material	Aluminium Tempered glass cover	Operating Temperature	-30°C to 50°C
Beam Angle	120°	Lifetime	50000 hours
CRI	>80	Warranty	5 years
SDCM	<5		
Electrical Classification	Class I		
Connection Type	Pre-wired with mains cable		

PHOTOMETRICS

(Example of LDVAL-CNP-MSF-HO-FP)

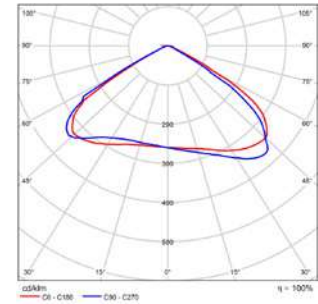

DIMENSIONS

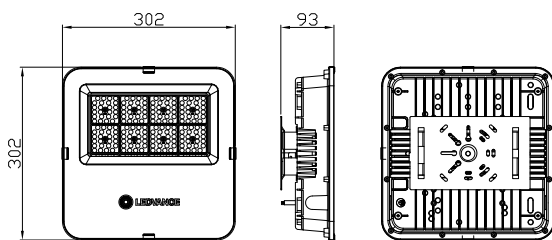

Surface mounting
60W, 90W, 110W
302x302x93mm

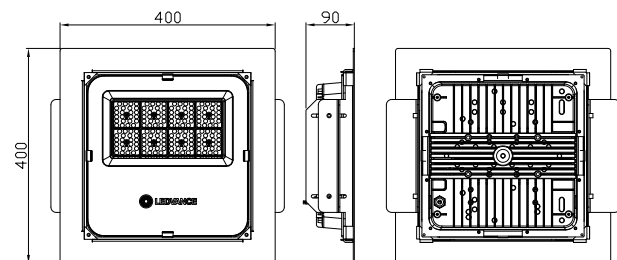

Recessed mounting
60W, 90W, 110W
400x400x90mm

ORDERING CODES - CANOPY LIGHT

VALUE
CLASS

Product name	EAN10	Model number	W	lm	K		lm/W	$\frac{l}{d}$ [mm]	$\frac{w}{h}$ [mm]	$\frac{h}{d}$ [mm]	
--------------	-------	--------------	---	----	---	--	------	-----------------------	-----------------------	-----------------------	--

SURFACE MOUNTING

LDVAL CANOPY MSF FP 60W 840 W VS1 LEDV	4058075537934	LDVCNPS60W840	60	8100	4000	120	135	302	302	93	3900
LDVAL CANOPY MSF FP 90W 840 W VS1 LEDV	4058075538016	LDVCNPS90W840	90	12150	4000	120	135	302	302	93	3900
LDVAL CANOPY MSF FP 110W 840 W VS1 LEDV	4058075538115	LDVCNPS110W840	110	14850	4000	120	135	302	302	93	3900

RECESSED MOUNTING

LDVAL CANOPY MRE FP 60W 840 W VS1 LEDV	4058075538924	LDVCNPR60W840	60	8100	4000	120	135	400	400	90	6300
LDVAL CANOPY MRE FP 90W 840 W VS1 LEDV	4058075538986	LDVCNPR90W840	90	12150	4000	120	135	400	400	90	6300
LDVAL CANOPY MRE FP 110W 840 W VS1 LEDV	4058075539044	LDVCNPR110W840	110	14850	4000	120	135	400	400	90	6300



CANOPY LIGHT



FLOODLIGHT

Applications: Public areas | Warehouses | Industrial | Building façades | Construction areas



**TRI COLOUR MULTI WATTAGE FLOODLIGHT
- LOW POWER**

116



**TRI COLOUR MULTI WATTAGE FLOODLIGHT
- MID POWER**

120



HIGH POWER FLOODLIGHT

124

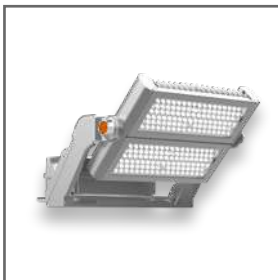

FLOODLIGHT MAX

128



SECURITY FLOODLIGHT

132

Tri Colour Multi Wattage Floodlight - Low Power

The new versatile and robust Tri Colour Multi Wattage Floodlight - Low Power offers both 3 colour settings and 3 power options in one. With added protection on top of its IP65 and IK06 rating, these high efficient fittings also have 800 hours of salt spray test with corrosion resistant paint coating and a surge protection of up to 2KV.



FEATURES AND BENEFITS

- 6/8/10W, 12/16/20W, 18/24/30W, 30/40/50W
- Tri colour in 3000K, 4000K and 6500K
- High efficacy 140lm/W
- IP65
- IK06
- Pre-wired with 1m mains cable
- Aluminium housing
- Surge protection of 1KV/2KV
- Marine grade coating of 800-hour salt spray test
- Lifetime 50,000 hours

AREAS OF APPLICATION

- Public spaces
- Outdoor residential areas
- Gardens and pathways
- Storage facilities
- Garages

AVAILABLE SIZES



6/8/10W
135x95x29mm



12/16/20W
135x110x29mm



18/24/30W
160x125.5x30mm



30/40/50W
200x150x29.6mm



SPECIFICATIONS

Wattage	6/8/10W, 12/16/20W, 18/24/30W, 30/40/50W
Lumens	1400, 2800, 4200, 7500
lm/W	140
CCT	3000/4500/6500K
IP Rating	IP65
IK Rating	IK06
Housing Material	Aluminium/Glass
Beam Angle	110°
CRI	>80
SDCM	<5
Electrical Classification	Class I

Connection Type	Pre wired with 1m mains cable
Voltage	110-277V AC
PF	>0.9
Frequency	50/60Hz
Surge Protection	1KV/2KV
Salt Spray	800 hours
Flicker Rate	<5%
Mounting Type	Surface mounting
Operating Temperature	-30°C to 50°C
Lifetime	50000 hours
Warranty	5 years

PHOTOMETRICS

(Example of LDVFL18-30WTRI)

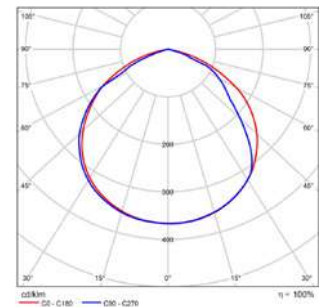

DIMENSIONS

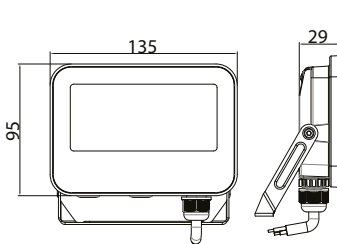

6/8/10W
135x95x29mm

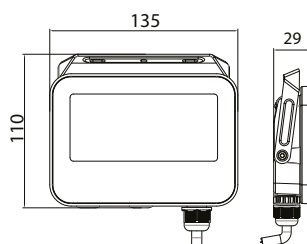

12/16/20W
135x110x29mm

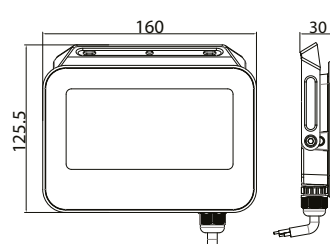

18/24/30W
160x125.5x30mm

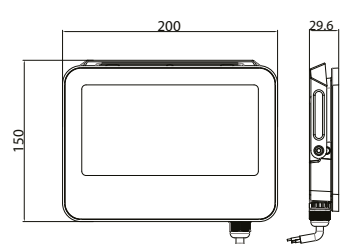

30/40/50W
200x150x29.6mm

ORDERING CODES - TRI COLOUR MULTI WATTAGE FLOODLIGHT - LOW POWER



Product name	EAN10	Model number	W	lm	K		lm/W	$\frac{l}{[mm]}$	$\frac{w}{[mm]}$	$\frac{h}{[mm]}$	
--------------	-------	--------------	---	----	---	--	------	------------------	------------------	------------------	--

TRI COLOUR MULTI WATTAGE FLOODLIGHT - LOW POWER

LDVAL FL 6/8/10W TRI 12X1 AU LEDV	4099854121883	LDVFL6-10WTRI	6/ 8/ 10	840/ 1100/ 1400	3000/ 4500/ 6500	110	140	135	29	110	415
LDVAL FL 12/16/20W TRI 12X1 AU LEDV	4099854121906	LDVFL12-20WTRI	12/ 16/ 20	1800/ 2300/ 2800	3000/ 4500/ 6500	110	140	135	29	110	417
LDVAL FL 18/24/30W TRI 8X1 AU LEDV	4099854121920	LDVFL18-30WTRI	18/ 24/ 30	2750/ 3600/ 4200	3000/ 4500/ 6500	110	140	160	30	125.5	540
LDVAL FL 30/40/50W TRI 8X1 AU LEDV	4099854121944	LDVFL30-50WTRI	30/ 40/ 50	4900/ 6200/ 7500	3000/ 4500/ 6500	110	140	200	29.6	150	780



TRI COLOUR MULTI WATTAGE FLOODLIGHT - LOW POWER

Tri Colour Multi Wattage Floodlight - Mid Power

The new versatile and robust Tri Colour Multi Wattage Floodlight - Mid Power offers both 3 colour settings and 3 power options in one. With added protection on top of its IP65 and IK07 rating, these high efficient fittings also have 800 hours of salt spray test with corrosion resistant paint coating and a surge protection of up to 6KV.



FEATURES AND BENEFITS

- 60/80/100W, 90/120/150W, 120/160/200W
- Tri colour in 3000K, 4000K and 6500K
- High efficacy 140lm/W
- 110° and 55°x100° beam option
- IP65
- IK07
- Pre-wired with 1m mains cable
- Housing material Aluminium
- Surge protection of 4KV/6KV
- Marine grade coating of 800-hour salt spray test
- Lifetime 50,000 hours

AREAS OF APPLICATION

- Public spaces
- Construction areas
- Car parks
- Stadiums and sporting facilities
- Commercial buildings

AVAILABLE SIZES



60/80/100W
300x222x45mm

90/120/150W
335x274x49mm

120/160/200W
390x305x58mm

SPECIFICATIONS

Wattage	60/80/100W, 90/120/150W, 120/160/200W	Connection Type	Pre wired with 1m mains cable
Lumens	14000, 21800, 29500	Voltage	110-277V AC
lm/W	140	PF	>0.9
CCT	3000/4500/6500K	Frequency	50/60Hz
IP Rating	IP65	Surge Protection	4KV/6KV
IK Rating	IK07	Salt Spray	800 hours
Housing Material	Aluminium-Alloy die castings Bracket: SGCC	Flicker Rate	<5%
Beam Angle	Symmetric 110°, Asymmetric 55°x100°	Mounting Type	Surface mounting
CRI	>80	Operating Temperature	-30°C to 50°C
SDCM	<5	Lifetime	50000 hours
Electrical Classification	Class I	Warranty	5 years

PHOTOMETRICS

(Example of LDVFL90-150WTRI)

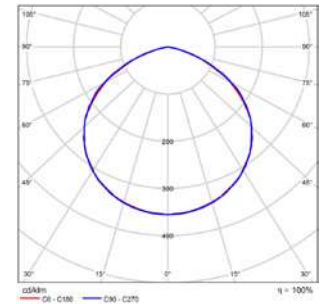

(Example of LDVFL90-150WASYTRI)

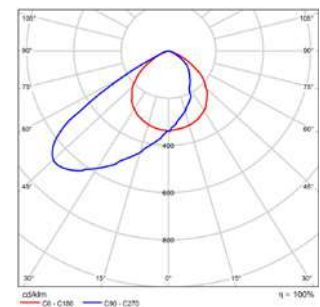

DIMENSIONS

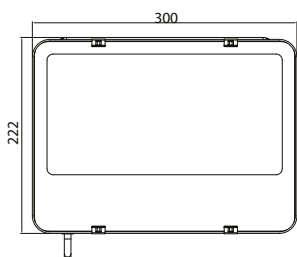

60/80/100W
300x222x45mm

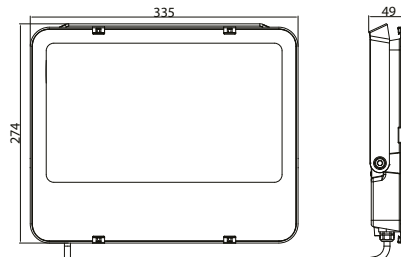

90/120/150W
335x274x49mm

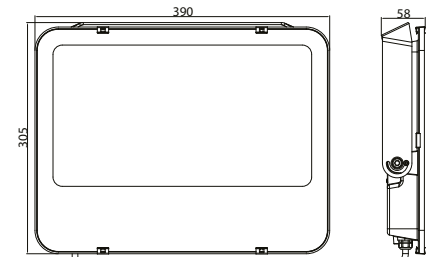

120/160/200W
390x305x58mm

ORDERING CODES - TRI COLOUR MULTI WATTAGE FLOODLIGHT - MID POWER



Product name	EAN10	Model number	W	lm	K	°	lm/w	l (mm)	w (mm)	h (mm)	ⓘ
--------------	-------	--------------	---	----	---	---	------	--------	--------	--------	---

SYMMETRIC

LDVAL FL 60/80/100W TRI 2X1 AU LEDV	4099854121968	LDVFL60-100WTRI	60/ 80/ 100	9400/ 12000/ 14000	3000/ 4500/ 6500	110	140	300	45	222	1850
LDVAL FL 90/120/150W TRI 2X1 AU LEDV	4099854122002	LDVFL90-150WTRI	90/ 120/ 150	13500/ 18000/ 21800	3000/ 4500/ 6500	110	140	335	49	274	2830
LDVAL FL 120/160/200W TRI 2X1 AU LEDV	4099854122040	LDVFL120-200WTRI	120/ 160/ 200	19500/ 25000/ 29500	3000/ 4500/ 6500	110	140	390	58	305	4100

ASYMMETRIC

LDVAL FL ASYM 60/80/100W TRI 2X1 AU LEDV	4099854121982	LDVFL60-100WASYTRI	60/ 80/ 100	8900/ 11600/ 14000	3000/ 4500/ 6500	55X100	140	300	45	222	2060
LDVAL FL ASYM 90/120/150W TRI 2X1 AU LEDV	4099854122026	LDVFL90-150WASYTRI	90/ 120/ 150	13200/ 17500/ 21000	3000/ 4500/ 6500	55X100	140	335	49	274	3050
LDVAL FL ASYM 120/160/200W TRI 2X1 AU LEDV	4099854122064	LDVFL120-200WASYTRI	120/ 160/ 200	18200/ 23500/ 28000	3000/ 4500/ 6500	55X100	140	390	58	305	4250



TRI COLOUR MULTI WATTAGE FLOODLIGHT - MID POWER

High Power Floodlight

The High Power Floodlight is ideal for many industrial and commercial floodlight projects. The floodlight can easily be switched for different wattages to suit the application. Available in two colour temperatures and a range of optics, 30° and 60° beam angles as well as an asymmetric version. Tough, strong and bright.



FEATURES AND BENEFITS

- 210/250/300W, 330/400/500W
- Single colour in 4000K and 6500K
- High efficacy up to 150 lm/W
- 30°, 60°, and 120°x90° beam options
- IP66
- IK08
- Aluminium housing
- Surge protection of 4KV/6KV
- Marine grade coating for additional sea salt protection
- Lifetime 50000 hours

AREAS OF APPLICATION

- Public spaces
- Construction areas
- Car parks
- Industrial and commercial applications

AVAILABLE SIZES



210/250/300W
432x415x100mm



330/400/500W
578x456x100mm

SPECIFICATIONS

Wattage	210/250/300W, 330/400/500W	PF	>0.9
Lumens	42000, 72000	Voltage	100-277V
lm/W	150	Frequency	50/60Hz
CCT	4000K, 6500K	Surge Protection	4KV/6KV
IP Rating	IP66	Salt Spray	500hrs
IK Rating	IK08	Mounting Type	Surface mounting
Housing Material	Aluminium	Operating Temperature	-40°C to 70°C
Beam Angle	30°, 60°, 120°x90°	Lifetime	50000 hours
CRI	>80	Warranty	5 years
SDCM	<5		
Electrical Classification	Class I		

PHOTOMETRICS

(Example of LDVFLHP500W12090D840)

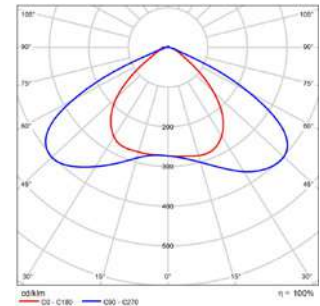

(Example of LDVFLHP500W30D840)

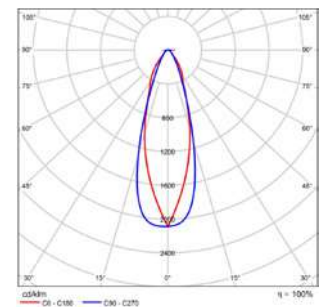

DIMENSIONS

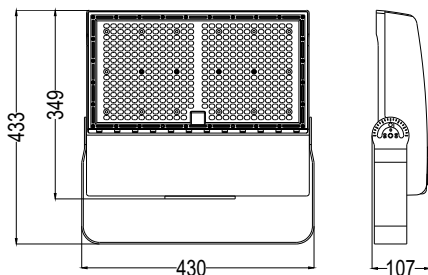

210/250/300W
432x415x100mm

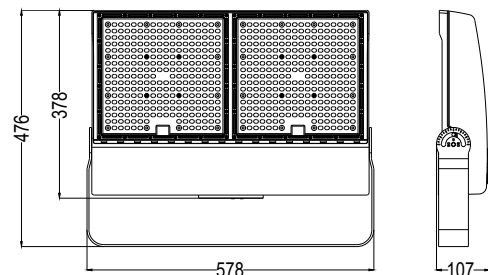

330/400/500W
578x456x100mm

ORDERING CODES - HIGH POWER FLOODLIGHT

VALUE
GLASS

IK 08

50000h



Product name	EAN10	Model number	W	lm	K	Δ ¹	lm/W	$\frac{l}{w}$ [mm]	$\frac{w}{h}$ [mm]	h [mm]	
--------------	-------	--------------	---	----	---	-----------------------	------	-----------------------	-----------------------	-----------	--

210/250/300W SYMMETRIC

LDV FL 210/250/300W 60D 840 WV VS1 LEDV	4099854148262	LDVFL300W60840	210/ 250/ 300	32000/ 36000/ 42000	4000	60	140	433	107	430	6600
LDV FL 210/250/300W 30D 840 WV VS1 LEDV	4099854148255	LDVFL300W30840	210/ 250/ 300	32000/ 36000/ 42000	4000	30	140	433	107	430	6600
LDV FL 210/250/300W 60D 865 WV VS1 LEDV	4099854117848	LDVFL300W60865	210/ 250/ 300	32000/ 36000/ 42000	6500	60	140	433	107	430	6600
LDV FL 210/250/300W 30D 865 WV VS1 LEDV	4099854117831	LDVFL300W30865	210/ 250/ 300	32000/ 36000/ 42000	6500	30	140	433	107	430	6600

210/250/300W ASYMMETRIC

LDV FL 210/250/300W 120X90D 840 WV VS1 LEDV	4099854148279	LDVFL300WASY840	210/ 250/ 300	32000/ 36000/ 42000	4000	120X90	140	433	107	430	6600
LDV FL 210/250/300W 120X90D 865 WV VS1 LEDV	4099854117855	LDVFL300WASY865	210/ 250/ 300	32000/ 36000/ 42000	6500	120X90	140	433	107	430	6600

330/420/500W SYMMETRIC

LDV FL 330/420/500W 60D 840 WV VS1 LEDV	4099854148231	LDVFL500W60840	330/ 420/ 500	48000/ 60000/ 72000	4000	60	140	578	107	476	9600
LDV FL 330/420/500W 30D 840 WV VS1 LEDV	4099854148224	LDVFL500W30840	330/ 420/ 500	48000/ 60000/ 72000	4000	30	140	578	107	476	9600
LDV FL 330/420/500W 60D 865 WV VS1 LEDV	4099854117688	LDVFL500W60865	330/ 420/ 500	48000/ 60000/ 72000	6500	60	140	578	107	476	9600
LDV FL 330/420/500W 30D 865 WV VS1 LEDV	4099854117664	LDVFL500W30865	330/ 420/ 500	48000/ 60000/ 72000	6500	30	140	578	107	476	9600

330/420/500W ASYMMETRIC

LDV FL 330/420/500W 120X90D 840 WV VS1 LEDV	4099854148248	LDVFL500WASY840	330/ 420/ 500	48000/ 60000/ 72000	4000	120X90	140	578	107	476	9600
LDV FL 330/420/500W 120X90D 865 WV VS1 LEDV	4099854117749	LDVFL500WASY865	330/ 420/ 500	48000/ 60000/ 72000	6500	120X90	140	578	107	476	9600

1 Asymmetrical light sources distribute light evenly in all directions. This type of light beam is recommended for both general lightings of large spaces and accent lighting for visual tasks. Asymmetrical lighting is ideal for concentrating the light beam in one direction.



HIGH POWER FLOODLIGHT

Floodlight Max

The Floodlight Max is a perfect solution to replace the traditional HID Floodlight luminaires into a more stylish, rugged, flexible and high-performance professional luminaires. Robust die cast aluminium housing rated IP66 and IK08 provides reliable ingress protection and long-term reliability. High quality heat dissipation and UV resistant integral PC lens deliver uniform and accurate illumination.



FEATURES AND BENEFITS

- 600W, 900W, 1200W
- Available in standard version and remote driver version
- Single colour in 5700K
- 1-10V dimming
- 10°, 30°, 60°, 50°X110° beam options
- IP66
- IK08
- Die-cast aluminium housing
- Lifetime 100000 hours

AREAS OF APPLICATION

- Public spaces
- Construction areas
- Car parks
- Stadiums and sporting facilities
- Commercial buildings

AVAILABLE SIZES



600W
590.6x659.5x279.3mm



900W
590.6x930x279.3mm



1200W
590.6x1111.4x281.6mm

SPECIFICATIONS

Wattage	600W, 900W, 1200W	Electrical Classification	Class I
Lumens	81000, 121000, 162000	Voltage	220-240V AC
lm/W	130-136	PF	>0.9
CCT	5700K	Frequency	50/60Hz
IP Rating	IP66	Surge Protection	10KV
IK Rating	IK08	Mounting Type	Surface mounting
Dimmable	1-10V	Operating Temperature	-30°C to 50°C
Housing Material	Die-cast aluminium Diffuser: PC lens and glass	Lifetime	100000 hours
Beam Angle	10°, 30°, 60°, 50°X110°	Warranty	5 years
CRI	>70		
SDCM	<5		

PHOTOMETRICS

(Example of LDVFL900W10D757)

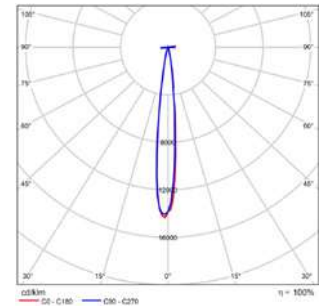

(Example of LDVFL900WAD757)

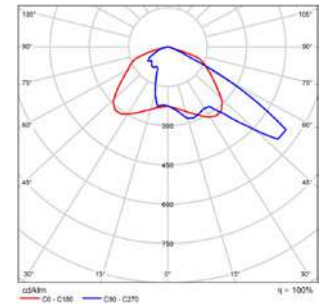

DIMENSIONS

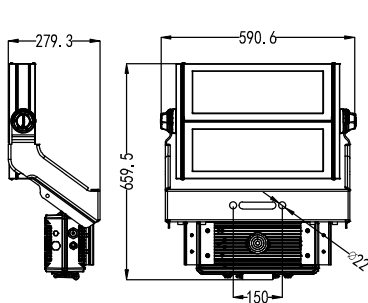

600W
590.6x659.5x279.3mm

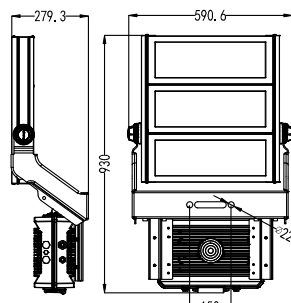

900W
590.6x930x279.3mm

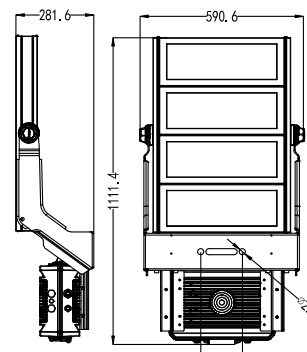

1200W
590.6x281.6x1111.4mm

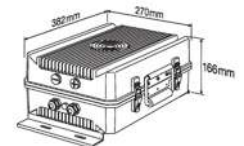

600W Power supply
382x188x146mm

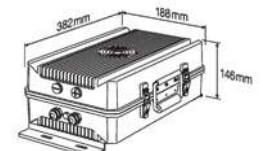

900W/1200W Power supply
382x270x166mm

ORDERING CODES - FLOODLIGHT MAX



Product name	EAN10	Model number	W	lm	K						
--------------	-------	--------------	---	----	---	--	--	--	--	--	--

FLOODLIGHT MAX (PLEASE ORDER POWER SUPPLY BELOW)

FL MAX LUM P 600W 757 SYM10 WALVS1 LEDV	4099854202865	LDVFL600W10D757	600	78000	5700	10	130	590.6	279.3.	659.5	15800
FL MAX LUM P 600W 757 SYM 30 WALVS1LEDV	4099854202872	LDVFL600W30D757	600	81000	5700	30	135	590.6	279.3.	659.5	15800
FL MAX LUM P 600W 757 SYM 60 WALVS1LEDV	4099854202889	LDVFL600W60D757	600	80500	5700	60	134	590.6	279.3.	659.5	15800
FL MAX LUM P600W 757 ASYM50X110 WALVS1LEDV	4099854202896	LDVFL600WAD757	600	82000	5700	55X110	136	590.6	279.3.	659.5	15800
FL MAX LUM P 900W 757 SYM 10 WALVS1LEDV	4099854202902	LDVFL900W10D757	900	117000	5700	10	130	590.6	279.3.	930	20800
FL MAX LUM P 900W 757 SYM 30 WALVS1LEDV	4099854202919	LDVFL900W30D757	900	121000	5700	30	134	590.6	279.3.	930	20800
FL MAX LUM P 900W 757 SYM 60 WALVS1LEDV	4099854202926	LDVFL900W60D757	900	120000	5700	60	133	590.6	279.3.	930	20800
FL MAX LUM P900W 757 ASYM50X110 WALVS1LEDV	4099854202933	LDVFL900WAD757	900	123000	5700	55X110	136	590.6	279.3.	930	20800
FL MAX LUM P 1200W 757 SYM10 WALVS1LEDV	4099854202940	LDVFL1200W10D757	1200	155000	5700	10	130	590.6	281.6	1111.4	31900
FL MAX LUM P 1200W 757 SYM30 WALVS1LEDV	4099854202957	LDVFL1200W30D757	1200	162000	5700	30	135	590.6	281.6	1111.4	31900
FL MAX LUM P 1200W 757 SYM60 WALVS1LEDV	4099854202964	LDVFL1200W60D757	1200	161000	5700	60	134	590.6	281.6	1111.4	31900
FL MAX LUM P 1200W 757 ASYM50X110 WALVS1LEDV	4099854202971	LDVFL1200WAD757	1200	164000	5700	55X110	136	590.6	281.6	1111.4	31900

Product name	EAN10	Model number	W				
--------------	-------	--------------	---	--	--	--	--

POWER SUPPLY

FL MAX POWER SUPPLY P 600W WAL 2X1LEDV	4099854202988	LDVFLPS600W	600	382	188	146	5400
FL MAX POWER SUPPLY P 900W WALVS1 LEDV	4099854203008	LDVFLPS900W	900	382	270	166	10500
FL MAX POWER SUPPLY P 1200W WAL VS1LEDV	4099854203015	LDVFLPS1200W	1200	382	270	166	12600



FLOODLIGHT MAX

Security Floodlight

The Security Floodlight has classic style aesthetics, designed to suit your outdoor security needs. Available in tri colour as a single or double adjustable head. Easy installation and low energy consumption along with 180° head and sensor rotation, makes the perfect outdoor residential fitting.



FEATURES AND BENEFITS

- 10W, 2X10W
- Microwave sensor option available
- Tri colour in 3000K, 4000K and 6500K
- High efficacy up to 100 lm/W
- IP65
- Housing material Aluminum
- Easy to install thanks to 6mm terminal block
- Lifetime 30000 hours

AREAS OF APPLICATION

- Public spaces
- Outdoor residential areas
- Gardens and pathways
- Storage facilities
- Garages

AVAILABLE SIZES



10W
183x144x114mm



10W with Micro Sensor
173x235x114mm



2X10W
242x132x170mm



2X10W with Micro Sensor
242x208x170mm

SPECIFICATIONS

Wattage	10W, 2X10W	SDCM	<6
Lumens	1000, 2000	Electrical Classification	Class II
lm/W	100	PF	>0.5
CCT	3000/4000K/6500K	Frequency	50/60Hz
IP Rating	IP65/54 (Sensor version IP54)	Mounting Type	Surface mounting
Sensor	Microwave sensor (optional)	Operating Temperature	-20°C to 50°C
Housing Material	Aluminium/ABS	Lifetime	30000 hours
Beam Angle	100°	Warranty	5 years
CRI	>80		

PHOTOMETRICS

(Example of LDVSFL10WTRI)

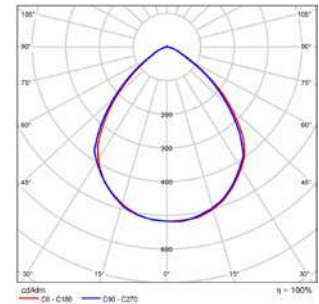

DIMENSIONS

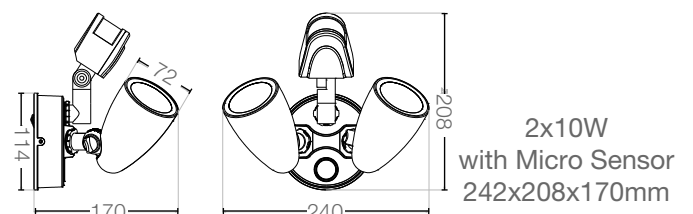
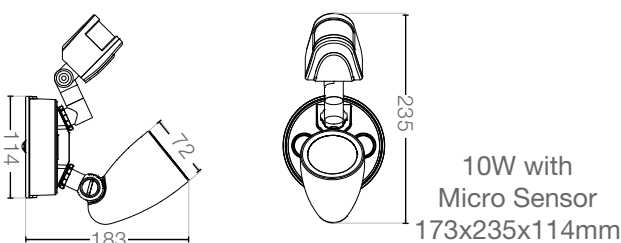
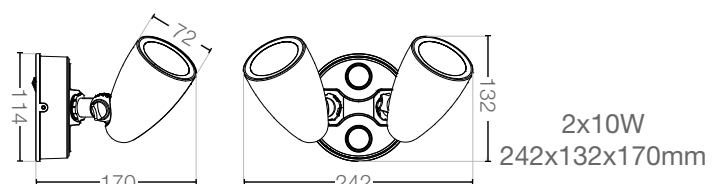
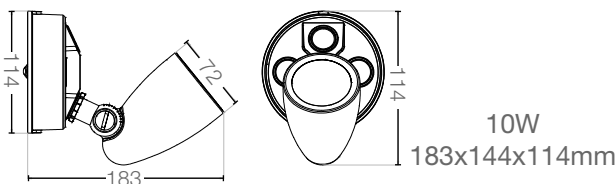

ORDERING CODES - SECURITY FLOODLIGHT



Product name	EAN10	Model number	W	lm	K	\angle	lm/W	L [mm]	W [mm]	h [mm]	
--------------	-------	--------------	---	----	---	----------	------	--------	--------	--------	--

STANDARD

LDVAL SECURITY FLOOD 10W TRI 12X1 LEDV	4058075542280	LDVSFL10WTRI	10	900/ 1000/ 1000	3000/ 4000/ 6500	100	90/ 100	183	144	114	400
LDVAL SECURITY FLOOD 2X10W TRI 12X1 LEDV	4058075542341	LDVSFL2X10WTRI	2X10	2X900/ 2X1000/ 2X1000	3000/ 4000/ 6500	100	90/ 100	242	132	170	650



Product name	EAN10	Model number	W	lm	K	\angle	lm/W	L [mm]	W [mm]	h [mm]	
--------------	-------	--------------	---	----	---	----------	------	--------	--------	--------	--

MICROWAVE SENSOR

LDVAL SECURITY FLOOD 10W TRI MS 12X1 LEDV	4058075542327	LDVSFL10WTRIMS	10	900/ 1000/ 1000	3000/ 4000/ 6500	100	90/ 100	173	235	114	450
LDVAL SECURITY FLOOD 2X10W TRI MS 12X1 LEDV	4058075542303	LDVSFL2X10WTRIMS	2X10	2X900/ 2X1000/ 2X1000	3000/ 4000/ 6500	100	90/ 100	242	208	170	700



SECURITY FLOODLIGHT



BULKHEAD AND OYSTER

Applications: Public areas | Stairways | Corridors | Workshops | Outdoor areas



ORBIS ULTRA SLIM OYSTER

138



TRI COLOUR OYSTER

142

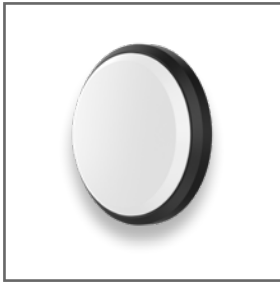

IP65 BULKHEAD

146

Orbis Ultra Slim Oyster

This stylish and slim Oyster is perfect for all residential applications, including bathrooms and kitchens. The slim low profile of 30mm in depth, combined with the back light halo effect, creates a sleek and modern look. Available in 3 sizes, each offering 3 colour temperatures in one fixture.



FEATURES AND BENEFITS

- 18W, 24W, 32W
- Available in Ø300mm, Ø420mm or Ø540mm
- Slim low profile 30mm in depth
- Tri colour in 3000K, 4000K and 6500K
- High efficacy up to 110lm/W
- Dimmable
- IP54
- Polypropylene housing
- Double insulated
- Easy to install thanks to large terminal block and quick connect backplate
- Lifetime 50000 hours

AREAS OF APPLICATION

- Public spaces
- All residential including kitchens and bathrooms
- Reception areas and foyers
- Corridors, stairways, and entrance areas
- Entrances and hallways

AVAILABLE SIZES



18W
Ø300x30mm



24W
Ø420x30mm



32W
Ø540x30mm

SPECIFICATIONS

Wattage	18W, 24W, 32W
Lumens	1850, 2650, 3680
lm/W	105
CCT	3000/4000K/6500K
IP Rating	IP54
IK Rating	IK02
Dimmable	Yes
Double Insulated	Yes
Housing Material	Polypropylene Base: ABS Trim: ABS
Beam Angle	120°
CRI	>80

SDCM	<6
Electrical Classification	Class II
Voltage	220-240V
PF	>0.9
Frequency	50/60Hz
Flicker Rate	<5%
Mounting Type	Surface mounting
Operating Temperature	-20°C to 40°C
Lifetime	50000 hours
Warranty	5 years

PHOTOMETRICS

(Example of LDVOYSTSLIM24WTRI)

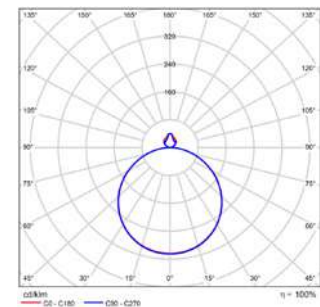

DIMENSIONS

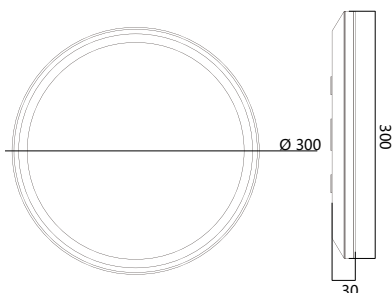

18W
Ø300x30mm

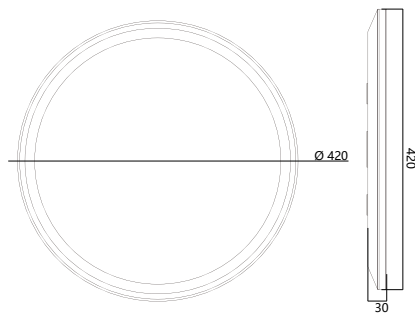

24W
Ø420x30mm

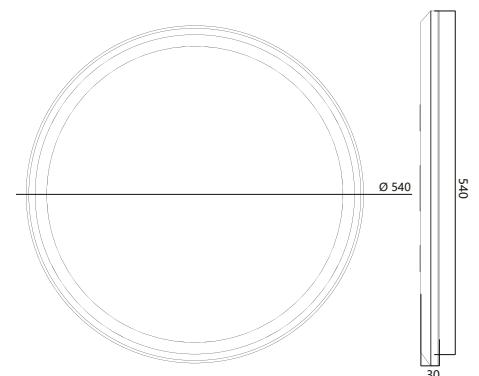

32W
Ø540x30mm

ORDERING CODES - ORBIS ULTRA SLIM OYSTER



Product name	EAN10	Model number	W	lm	K		lm/W				
--------------	-------	--------------	---	----	---	--	------	--	--	--	--

ORBIS ULTRA SLIM OYSTER

LDVAL OYSTSLIM18W IP54DIMTRI 10X1 AULEDV	4099854138522	LDVOYSTSLIM18WTRI	18	1700/ 1850/ 1800	3000/ 4000/ 6500	120	90/ 105/ 100	✓	300	30	680
LDVAL OYSTSLIM24W IP54DIMTRI 8X1 AULEDV	4099854138546	LDVOYSTSLIM24WTRI	24	2400/ 2650/ 2600	3000/ 4000/ 6500	120	105/ 115/ 110	✓	420	30	1150
LDVAL OYSTSLIM32W IP54DIMTRI 5X1 AULEDV	4099854138560	LDVOYSTSLIM32WTRI	32	3350/ 3680/ 3550	3000/ 4000/ 6500	120	105/ 115/ 110	✓	540	30	1830

1 Brightness can be adjusted using a compatible dimmer. See below table for applicative dimmer.

Dimmer brand	Dimming mode	Pin-Min	Pin-Max	Io-Min	Io-Max	Typical	Dimming range
LDVOYSTSLIM18WTRI							
1 MEDM	BOTH	0.00	18.66	0	44	45	0.00% 100.0%
2 32E450UDM	BOTH	3.10	18.70	1	45	45	2.22% 100.0%
3 CAT400L	REVERSE-PHASE	3.10	20.47	1	45	45	2.22% 100.0%
4 SDA450	FORWARD-PHASE	1.67	19.38	1	45	45	2.22% 100.0%
5 MMDM/PB	FORWARD-PHASE	0.78	18.66	0	46	45	0.00% 100.0%
6 LEDVANCE	REVERSE-PHASE	0.93	17.54	0	45	45	0.00% 100.0%

Dimmer brand	Dimming mode	Pin-Min	Pin-Max	Io-Min	Io-Max	Typical	Dimming range
LDVOYSTSLIM24WTRI							
1 MEDM	BOTH	0.51	23.53	0	54	54	0.00% 100.0%
2 32E450UDM	BOTH	4.25	23.64	2	55	54	3.70% 100.0%
3 CAT400L	REVERSE-PHASE	4.14	23.95	2	52	54	3.70% 100.0%
4 SDA450	FORWARD-PHASE	1.95	22.06	1	50	54	1.85% 100.0%
5 MMDM/PB	FORWARD-PHASE	0.87	23.40	0	54	54	0.00% 100.0%
6 LEDVANCE	REVERSE-PHASE	1.00	22.87	0	55	55	0.00% 100.0%

Dimmer brand	Dimming mode	Pin-Min	Pin-Max	Io-Min	Io-Max	Typical	Dimming range
LDVOYSTSLIM32WTRI							
1 MEDM	BOTH	0.00	31.05	0	70	71	0.00% 100.0%
2 32E450UDM	BOTH	4.68	30.96	1	70	71	1.41% 100.0%
3 CAT400L	REVERSE-PHASE	4.50	32.30	1	67	71	1.41% 100.0%
4 SDA450	FORWARD-PHASE	2.10	28.00	1	62	71	1.41% 100.0%
5 MMDM/PB	FORWARD-PHASE	0.88	31.05	0	69	71	0.00% 100.0%
6 LEDVANCE	REVERSE-PHASE	1.00	30.63	0	71	71	0.00% 100.0%

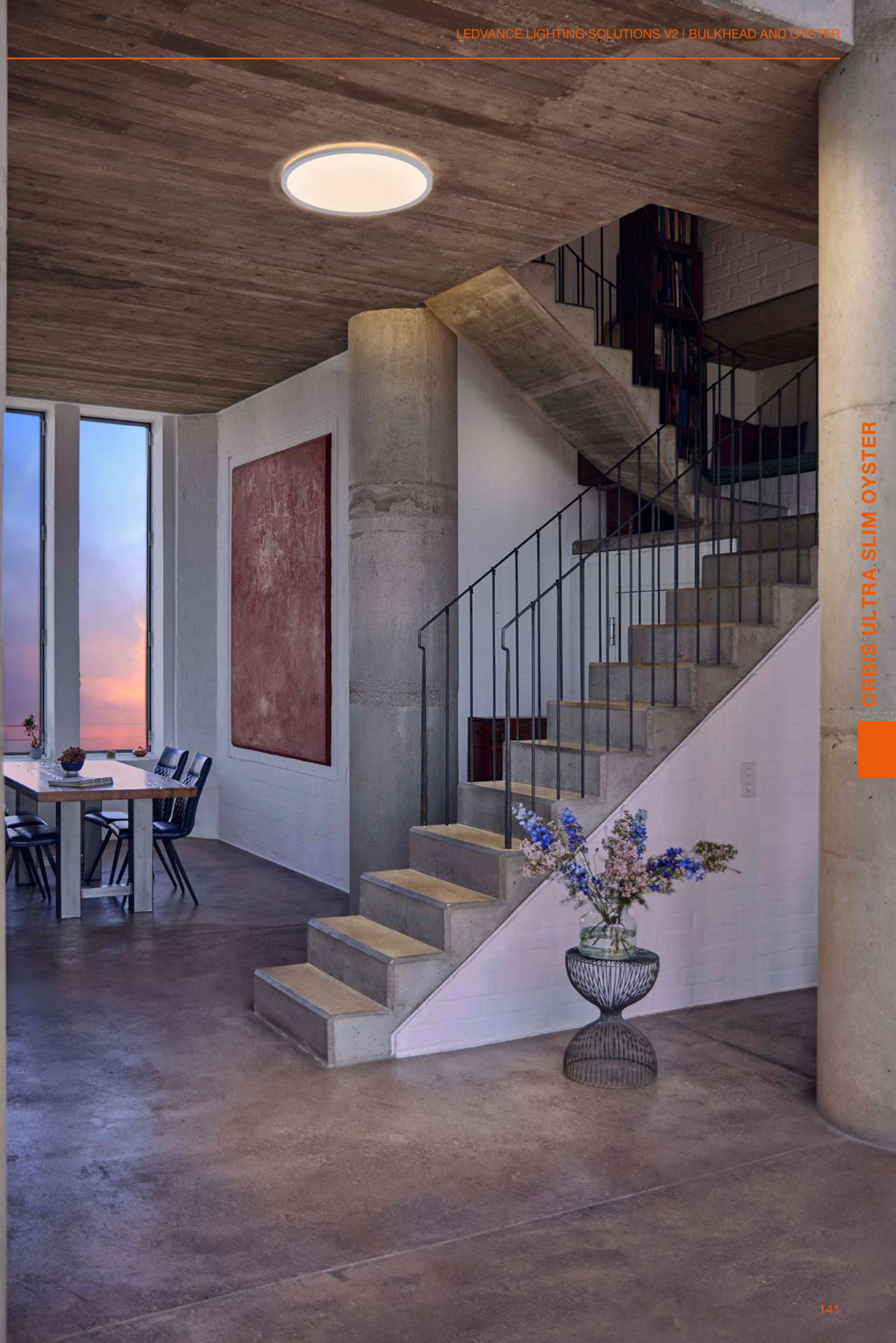

ORBIS ULTRA SLIM OYSTER



Tri Colour Oyster

The Tri Colour Oyster features a classic ceiling oyster design with a selection of the light colour temperatures. With tri colour switch, you can adjust the colour temperature to match the perfect lighting ambience in premium residential or commercial applications.



FEATURES AND BENEFITS

- 13W, 15W, 18W, 24W
- Available in Ø250mm, Ø300mm, Ø350mm or Ø400mm
- Tri colour in 3000K, 4000K and 5000K
- High efficacy up to 95lm/W
- IP20
- Polycarbonate housing
- Lifetime 30000 hours

AREAS OF APPLICATION

- Public spaces
- Dry residential such as bedrooms and living areas.
- Reception areas and foyers
- Corridors, stairways, and entrance areas
- Entrances and hallways

AVAILABLE SIZES



13W
Ø250x88mm



15W
Ø300x105mm



18W
Ø350x110mm



24W
Ø400x120mm

SPECIFICATIONS

Wattage	13W, 15W, 18W, 24W	CRI	>80
Lumens	1235, 1425, 1710, 2280	Electrical Classification	Class II
lm/W	120	PF	>0.9
CCT	3000/4000/5000K	Frequency	50/60Hz
IP Rating	IP20	Mounting Type	Surface mounting
IK Rating	IK03	Lifetime	30000 hours
Housing Material	Polycarbonate	Warranty	5 years
Beam Angle	120°		

PHOTOMETRICS

(Example of LDWALOYSTER18WTRI)

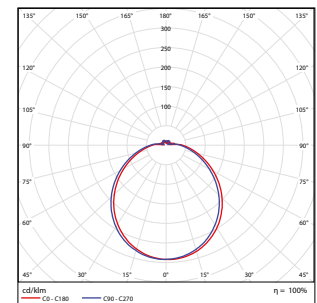

DIMENSIONS

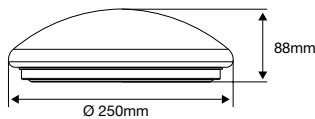

13W
Ø250x88mm

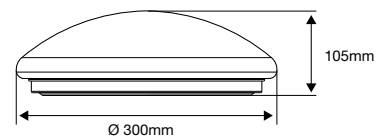

15W
Ø300x105mm

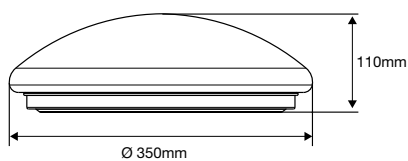

18W
Ø350x110mm

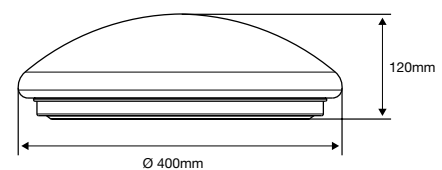

24W
Ø400x120mm

ORDERING CODES - TRI COLOUR OYSTER



Product name	EAN10	Model number	W	lm	K	°	lm/W	°	Ø (mm)	h (mm)	g
--------------	-------	--------------	---	----	---	---	------	---	--------	--------	---

TRI COLOUR OYSTER

LDVAL CEILING TRI 250MM 13W 5X1	4058075207509	LDWVALOYSTER13WTRI	13	1235	3000/ 4000/ 5000	120	80-95	×	250	88	310
LDVAL CEILING TRI 300MM 15W 5X1	4058075207523	LDWVALOYSTER15WTRI	15	1425	3000/ 4000/ 5000	120	80-95	×	300	105	430
LDVAL CEILING TRI 350MM 18W 5X1	4058075207547	LDWVALOYSTER18WTRI	18	1710	3000/ 4000/ 5000	120	80-95	×	350	110	530
LDVAL CEILING TRI 400MM 24W 5X1	4058075207561	LDWVALOYSTER24WTRI	24	2280	3000/ 4000/ 5000	120	80-95	×	400	120	680

TRI COLOUR OYSTER



TRI COLOUR OYSTER



IP65 Bulkhead

IP65 Bulkhead is a stylish and contemporary designed luminaire. Suitable for all outdoor applications due to its high ingress and impact protection of IP65 and IK06. Made with polycarbonate materials to offer a high corrosion resistance from all elements. Available in round and oval, 3 wattages with a black or white finish.

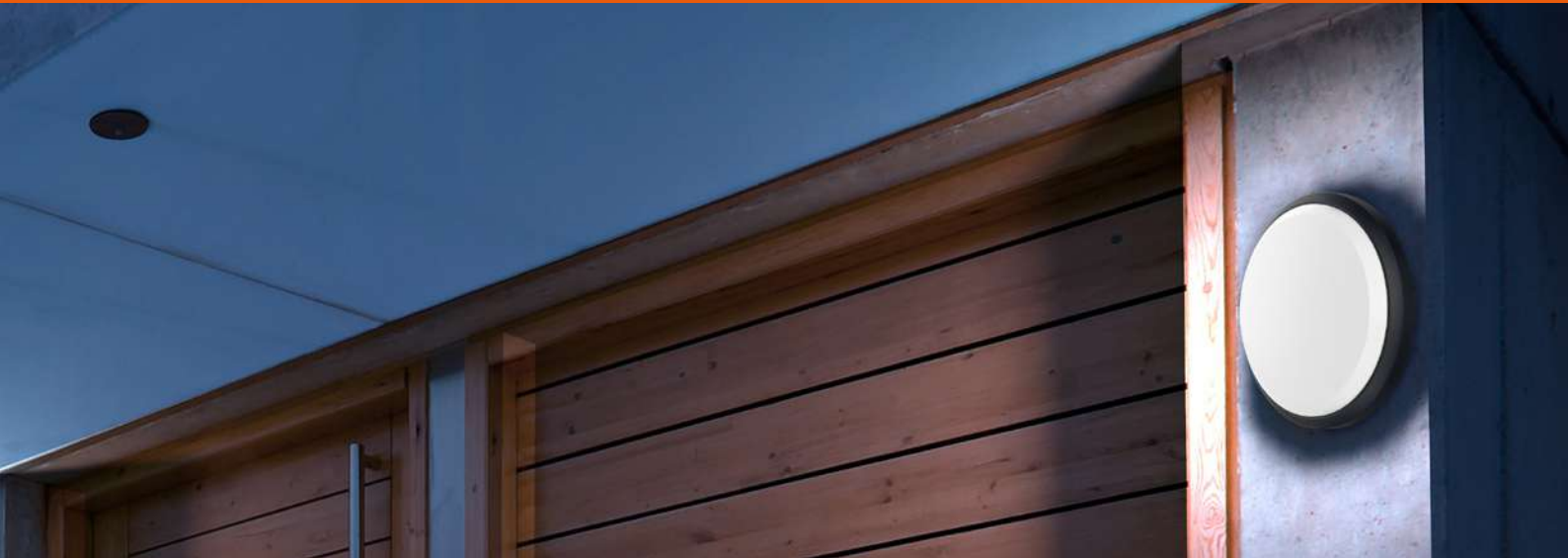

FEATURES AND BENEFITS

- 15W, 20W, 24W
- Available in Ø180x45mm, Ø220x45mm, Ø280x60mm, 200x100x45mm and 265x132x45mm
- Available in round and oval shapes, white or black colour options
- Single colour in 3000K, 4000K and 6500K
- High efficacy up to 90lm/W
- IP65
- IK06
- Polypropylene housing
- Lifetime 25000 hours

AREAS OF APPLICATION

- Public spaces
- Gardens and pathways
- Sheltered outdoor areas
- Corridors, stairways, and entrance areas
- Passages and underpasses

AVAILABLE SIZES



Oval 15W
200x100x45mm



Oval 20W
265x132x45mm



Round 15W
Ø180x45mm



Round 20W
Ø220x45mm



Round 24W
Ø280x60mm

AVAILABLE COLOUR



Black Trim



White Trim

SPECIFICATIONS

Wattage	15W, 20W, 24W	Voltage	220-240V
Lumens	1350, 1800, 2250	PF	>0.5
lm/W	90	Frequency	50/60Hz
CCT	3000K, 4000K, 6500K	Surge Protection	500V
IP Rating	IP65	Mounting Type	Wall and surface mounting
IK Rating	IK06	Operating Temperature	-20°C to 45°C
Housing Material	Polypropylene	Lifetime	30000 hours
Beam Angle	120°	Warranty	5 years
CRI	>80		
SDCM	<6		
Electrical Classification	Class II		

PHOTOMETRICS

(Example of LDVBHO15W840)

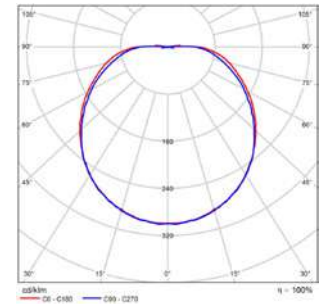

DIMENSIONS

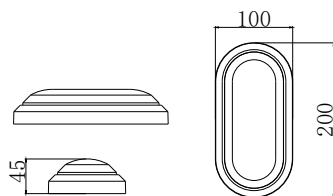

Oval 15W
200x100x45mm

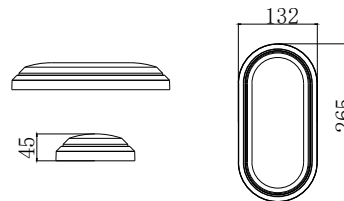

Oval 20W
265x132x45mm

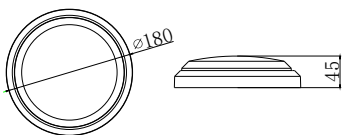

Round 15W
Ø180x45mm

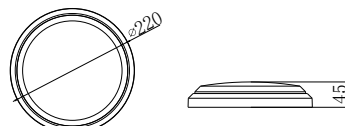

Round 20W
Ø220x45mm

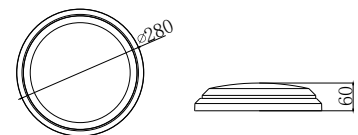

Round 24W
Ø280x60mm

ORDERING CODES - IP65 BULKHEAD



Product name	EAN10	Model number	W	lm	K	°	lm/W	°	l (mm)	w (mm)	h (mm)	h (mm)
--------------	-------	--------------	---	----	---	---	------	---	--------	--------	--------	--------

BLACK ROUND



LDECO BH 15W/830 BKR IP65 20X1 LEDV	4099854096679	LDVBHR15W830BLK	15	1200	3000	120	80	×	180	180	45	200
LDECO BH 15W/840 BKR IP65 20X1 LEDV	4099854096693	LDVBHR15W840BLK	15	1350	4000	120	90	×	180	180	45	200
LDECO BH 15W/865 BKR IP65 20X1 LEDV	4099854096976	LDVBHR15W865BLK	15	1350	6500	120	90	×	180	180	45	200
LDECO BH 20W/830 BKR IP65 20X1 LEDV	4099854097171	LDVBHR20W830BLK	20	1600	3000	120	80	×	220	220	45	280
LDECO BH 20W/840 BKR IP65 20X1 LEDV	4099854097218	LDVBHR20W840BLK	20	1800	4000	120	90	×	220	220	45	280
LDECO BH 20W/865 BKR IP65 20X1 LEDV	4099854097256	LDVBHR20W865BLK	20	1800	6500	120	90	×	220	220	45	280
LDECO BH 24W/830 BKR IP65 10X1 LEDV	4099854097478	LDVBHR24W830BLK	24	2000	4000	120	80	×	280	280	60	410
LDECO BH 24W/840 BKR IP65 10X1 LEDV	4099854097492	LDVBHR24W840BLK	24	2250	4000	120	90	×	280	280	60	410
LDECO BH 24W/865 BKR IP65 10X1 LEDV	4099854097539	LDVBHR24W865BLK	24	2250	6500	120	90	×	280	280	60	410

WHITE ROUND



LDECO BH 15W/830 WTR IP65 20X1 LEDV	4099854096594	LDVBHR15W830WH	15	1200	3000	120	80	×	180	180	45	200
LDECO BH 15W/840 WTR IP65 20X1 LEDV	4099854096617	LDVBHR15W840WH	15	1350	4000	120	90	×	180	180	45	200
LDECO BH 15W/865 WTR IP65 20X1 LEDV	4099854096655	LDVBHR15W865WH	15	1350	6500	120	90	×	180	180	45	200
LDECO BH 20W/830 WTR IP65 20X1 LEDV	4099854096990	LDVBHR20W830WH	20	1600	3000	120	80	×	220	220	45	280
LDECO BH 20W/840 WTR IP65 20X1 LEDV	4099854097010	LDVBHR20W840WH	20	1800	4000	120	90	×	220	220	45	280
LDECO BH 20W/865 WTR IP65 20X1 LEDV	4099854097119	LDVBHR20W865WH	20	1800	6500	120	90	×	220	220	45	280
LDECO BH 24W/830 WTR IP65 10X1 LEDV	4099854097294	LDVBHR24W830WH	24	2000	3000	120	80	×	280	280	60	410
LDECO BH 24W/840 WTR IP65 10X1 LEDV	4099854097379	LDVBHR24W840WH	24	2250	4000	120	90	×	280	280	60	410
LDECO BH 24W/865 WTR IP65 10X1 LEDV	4099854097454	LDVBHR24W865WH	24	2250	6500	120	90	×	280	280	60	410

ORDERING CODES - IP65 BULKHEAD



Product name	EAN10	Model number	W	lm	K	Δ	lm/w	γ	$\frac{l}{[mm]}$	$\frac{w}{[mm]}$	$\frac{h}{[mm]}$	θ
--------------	-------	--------------	---	----	---	----------	------	----------	------------------	------------------	------------------	----------

BLACK OVAL



LDECO BH 15W/830 BK OV IP65 20X1 LEDV	4099854098932	LDVBHO15W830BLK	15	1200	3000	120	80	×	200	100	45	160
LDECO BH 15W/840 BK OV IP65 20X1 LEDV	4099854098994	LDVBHO15W840BLK	15	1350	4000	120	90	×	200	100	45	160
LDECO BH 15W/865 BK OV IP65 20X1 LEDV	4099854099038	LDVBHO15W865BLK	15	1350	6500	120	90	×	200	100	45	160
LDECO BH 20W/830 BK OV IP65 20X1 LEDV	4099854099151	LDVBHO20W830BLK	20	1650	3000	120	80	×	265	132	45	280
LDECO BH 20W/840 BK OV IP65 20X1 LEDV	4099854099175	LDVBHO20W840BLK	20	1800	4000	120	90	×	265	132	45	280
LDECO BH 20W/865 BK OV IP65 20X1 LEDV	4099854099212	LDVBHO20W865BLK	20	1800	6500	120	90	×	265	132	45	280

WHITE OVAL



LDECO BH 15W/830 WT OV IP65 20X1 LEDV	4099854098796	LDVBHO15W830WH	15	1200	3000	120	80	×	200	100	45	160
LDECO BH 15W/840 WT OV IP65 20X1 LEDV	4099854098819	LDVBHO15W840WH	15	1350	4000	120	90	×	200	100	45	160
LDECO BH 15W/865 WT OV IP65 20X1 LEDV	4099854098857	LDVBHO15W865WH	15	1350	6500	120	90	×	200	100	45	160
LDECO BH 20W/830 WT OV IP65 20X1 LEDV	4099854099052	LDVBHO20W830WH	20	1650	3000	120	80	×	265	132	45	280
LDECO BH 20W/840 WT OV IP65 20X1 LEDV	4099854099076	LDVBHO20W840WH	20	1800	4000	120	90	×	265	132	45	280
LDECO BH 20W/865 WT OV IP65 20X1 LEDV	4099854099137	LDVBHO20W865WH	20	1800	6500	120	90	×	265	132	45	280



SENSOR, DIMMER AND ECG

Applications: Public areas | Shops | Stairways | Corridors | Foyers | Kitchens | Gardens



PIR AND MICROWAVE SENSORS

152



VALUE DIMMERS

160



IP20 ELECTRONIC TRANSFORMER 60W

162

PIR and Microwave Sensors

The LEDVANCE professional sensor range is energy efficient, stylish, and versatile. Offering both PIR and Microwave sensors suitable for ceiling or wall mounting with compatible dimming and remote controllers.



FEATURES AND BENEFITS

- Sensor selection, placement and programming improves functionality and achieve the biggest energy saving
- Multiple options for mounting including indoor (IP20), outdoor (IP40) with 180° or 360° options
- Available for daylight detection to switch on your lighting at dusk and off again at dawn
- Adjustable timer and ambient luminance level via knob switches

AREAS OF APPLICATION

- Public areas
- Stairways
- Corridors
- Foyers
- Gardens

PIR MOTION SENSOR FOR SURFACE MOUNTING



LDVSENSORPIRCS360
Ø115x55mm



LDVSENSORPIRCSF360
Ø120x29mm

SPECIFICATIONS

LDVSENSORPIRCS360

Wattage	0.9W
IP Rating	IP20
Sensing Method	PIR
Detect Angle	360°
Electrical Classification	Class II
Voltage	220-240V
Frequency	50/60Hz
Mounting Type	Surface mounting
Ambient Light of Daylight Sensing	10-2000 lux adjustable
Timer Min	10 sec
Timer Max	7 min
Detection Moving Speed	0.6-1.5m/s
Rated Load GLS/CFLi/LED	1200/300/300W
Max Relay Current	6A
Detection Distance Max	6m
Installation Height	2.2-4m
Surge Protection	1KV
Operating Temperature	-20°C to 45°C
Warranty	5 years

LDVSENSORPIRCSF360

Wattage	0.9W
IP Rating	IP20
Sensing Method	PIR
Detect Angle	360°
Electrical Classification	Class II
Voltage	220-240V
Frequency	50/60Hz
Mounting Type	Surface mounting
Ambient Light of Daylight Sensing	10-2000 lux adjustable
Timer Min	10 sec
Timer Max	10 min
Detection Moving Speed	0.6-1.5m/s
Rated Load GLS/CFLi/LED	2000/1000/1000W
Max Relay Current	10 A
Detection Distance Max	2-6m adjustable
Installation Height	2.2-4m
Surge Protection	1KV
Operating Temperature	-20°C to 45°C
Warranty	5 years

SENSITIVITY

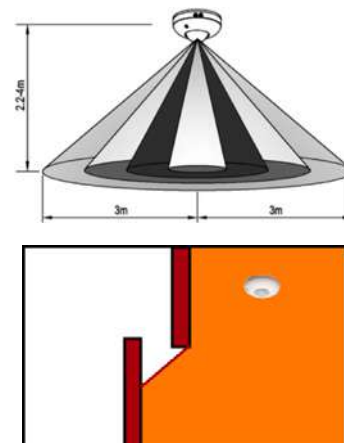
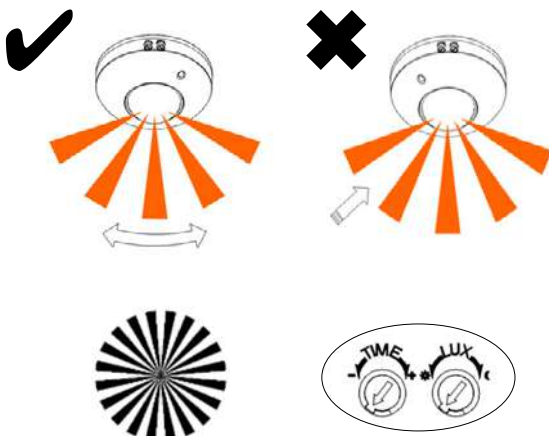

PIR MOTION SENSOR FOR RECESSED MOUNTING



LDVSENSORPIRCR360
76x61.5x76mm



DVSENSORPIRCRA360
70x80x62mm

SPECIFICATIONS

LDVSENSORPIRCR360

Wattage	0.9W
IP Rating	IP20
Sensing Method	PIR
Detect Angle	360°
Electrical Classification	Class II
Voltage	220-240V
Frequency	50/60Hz
Mounting Type	Recessed mounting
Ambient Light of Daylight Sensing	10-2000 lux adjustable
Timer Min	10 sec
Timer Max	7 min
Detection Moving Speed	0.6-1.5m/s
Rated Load GLS/CFLi/LED	1200/300/300W
Max Relay Current	6A
Detection Distance Max	6m
Installation Height	2.2-4m
Surge Protection	1KV
Operating Temperature	-20°C to 45°C
Warranty	5 years

DVSENSORPIRCRA360

Wattage	0.9W
IP Rating	IP20
Sensing Method	PIR
Detect Angle	360°
Electrical Classification	Class II
Voltage	220-240V
Frequency	50/60Hz
Mounting Type	Recessed mounting
Ambient Light of Daylight Sensing	3-2000 lux adjustable
Timer Min	10 sec
Timer Max	15 min
Detection Moving Speed	0.6-1.5m/s
Rated Load GLS/CFLi/LED	1200/300/300W
Max Relay Current	6A
Detection Distance Max	8m
Installation Height	2.2-4m
Surge Protection	1KV
Operating Temperature	-20°C to 45°C
Warranty	5 years

SENSITIVITY

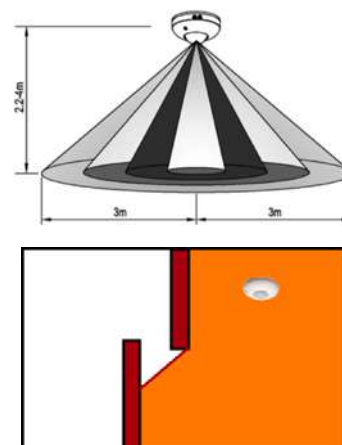
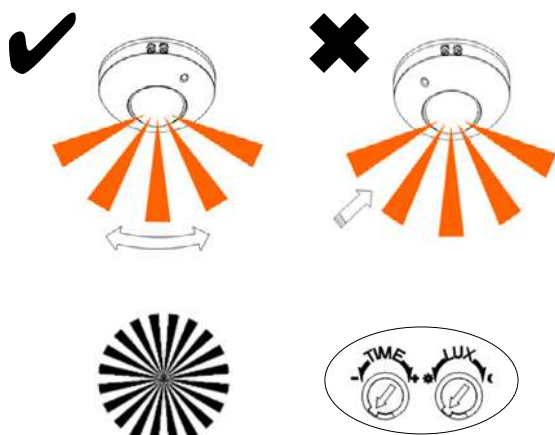

PIR MOTION SENSOR FOR WALL/SURFACE MOUNTING



LDVSENSORPIRWSAD180A
86.5x65.5x83mm



LDVSENSORPIRWSAD180B
86.5x50x155.5mm

SPECIFICATIONS

LDVSENSORPIRWSAD180A

Wattage	0.9W
IP Rating	IP44
Sensing Method	PIR
Detect Angle	180°
Electrical Classification	Class II
Voltage	220-240V
Frequency	50/60Hz
Mounting Type	Wall mounting
Ambient Light of Daylight Sensing	10-2000 lux adjustable
Timer Min	10 sec
Timer Max	7 min
Detection Moving Speed	0.6-1.5m/s
Rated Load GLS/CFLi/LED	1200/300/300W
Max Relay Current	6A
Detection Distance Max	12m
Installation Height	1.8-2.5m
Surge Protection	1KV
Operating Temperature	-20°C to 45°C
Warranty	5 years

LDVSENSORPIRWSAD180B

Wattage	0.9W
IP Rating	IP20
Sensing Method	PIR
Detect Angle	180°
Electrical Classification	Class II
Voltage	220-240V
Frequency	50/60Hz
Mounting Type	Wall mounting
Ambient Light of Daylight Sensing	10-2000 lux adjustable
Timer Min	10 sec
Timer Max	7 min
Detection Moving Speed	0.6-1.5m/s
Rated Load GLS/CFLi/LED	1200/300/300W
Max Relay Current	6A
Detection Distance Max	2-12m adjustable
Installation Height	1.8-2.5m
Surge Protection	1KV
Operating Temperature	-20°C to 45°C
Warranty	5 years

SENSITIVITY

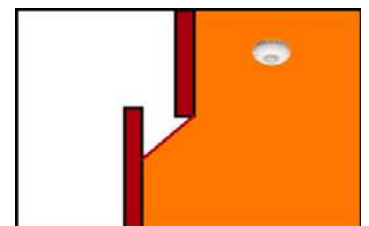
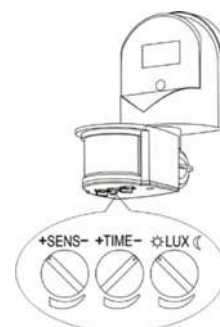
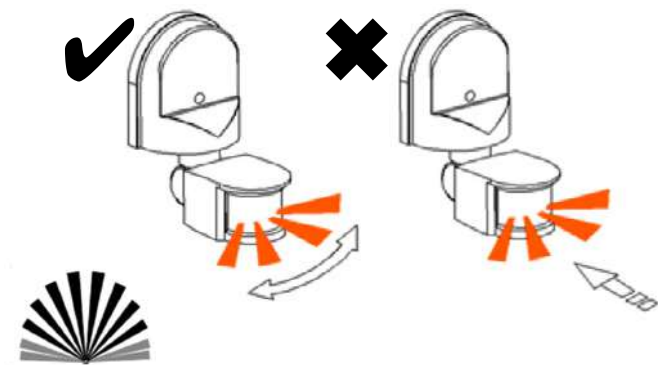

ORDERING CODES - PIR MOTION SENSORS

VALUE
CLASS

30000h

LEDVANCE
5 year
guarantee

Product Name	EAN10	Model Number	CUT OUT [mm]	l [mm]	w [mm]	h [mm]	
--------------	-------	--------------	-----------------	-----------	-----------	-----------	--

PIR MOTION SENSOR FOR SURFACE MOUNTING

MS-SV-INF-CS-360-230V-IP20 10X1 LEDV	4058075372955	LDVSENSORPIRCS360	-	115	115	55	139.8
MS-SV-INF-CS-F-360-230V-IP20 10X1 LEDV	4058075372979	LDVSENSORPIRCSF360	-	120	120	29	90

PIR MOTION SENSOR FOR RECESSED MOUNTING

MS-SV-INF-CR-360-230V-IP20 10X1 LEDV	4058075383258	LDVSENSORPIRCR360	Ø61	76	61.5	76	82.2
MS-SV-INF-CR-A-360-230V-IP20 10X1 LEDV	4058075373013	LDVSENSORPIRACRA360	Ø69	70	80	62	69.3

VALUE
CLASS

30000h

LEDVANCE
5 year
guarantee

Product Name	EAN10	Model Number	l [mm]	w [mm]	h [mm]	
--------------	-------	--------------	-----------	-----------	-----------	--

PIR MOTION SENSOR FOR WALL/SURFACE MOUNTING

MS-SV-INF-WS-AD-180-230V-IP44-A 10X1 LEDV	4058075373037	LDVSENSORPIRWSAD180A	86.5	65.5	83	117.6
MS-SV-INF-WS-AD-180-230V-IP44-B 10X1 LEDV	4058075373051	LDVSENSORPIRWSAD180B	86.5	50	155.5	173.1

MICROWAVE MOTION SENSOR FOR RECESSED MOUNTING



LDVSENSORMICCR360
80x61.5x76mm



LDVSENSORMICCRA360
80x80x59mm

SPECIFICATIONS

LDVSENSORMICCR360

Wattage	0.9W
IP Rating	IP20
Sensing Method	Microwave
Detect Angle	360°
Electrical Classification	Class II
Voltage	220-240V
Frequency	50/60Hz
Mounting Type	Recessed mounting
Ambient Light of Daylight Sensing	10-2000 lux adjustable
Timer Min	10 sec
Timer Max	15 min
Detection Moving Speed	0.6-1.5m/s
Rated Load GLS/CFLi/LED	1200/300/300W
Max Relay Current	6A
Detection Distance Max	2-8m radius adjustable
Installation Height	1.5-3.5m
Surge Protection	1KV
Operating Temperature	-35°C to 50°C
Warranty	5 years

LDVSENSORMICCRA360

Wattage	0.9W
IP Rating	IP20
Sensing Method	Microwave
Detect Angle	360°
Electrical Classification	Class II
Voltage	220-240V
Frequency	50/60Hz
Mounting Type	Recessed mounting
Ambient Light of Daylight Sensing	10-2000 lux adjustable
Timer Min	10 sec
Timer Max	15 min
Detection Moving Speed	0.6-1.5m/s
Rated Load GLS/CFLi/LED	1200/300/300W
Max Relay Current	6A
Detection Distance Max	8m radius
Installation Height	1.5-3.5m
Surge Protection	1KV
Operating Temperature	-35°C to 50°C
Warranty	5 years

SENSITIVITY

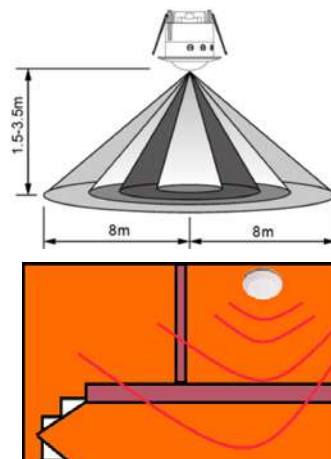
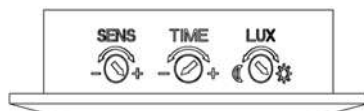
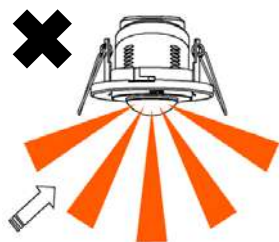
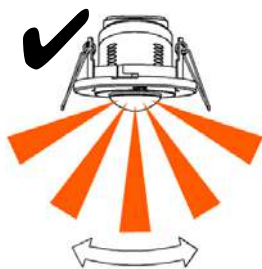

MICROWAVE MOTION SENSOR FOR BUILT-IN



LDVSENSORMICIL360
75x36x25mm

SPECIFICATIONS

LDVSENSORMICIL360

Wattage	0.9W
IP Rating	IP20
Sensing Method	Microwave
Detect Angle	360°
Electrical Classification	Class II
Voltage	220-240V
Frequency	50/60Hz
Mounting Type	Built-in
Ambient Light of Daylight Sensing	5-2000 lux adjustable
Timer Min	10 sec
Timer Max	15 min
Detection Moving Speed	0.6-1.5m/s
Rated Load GLS/CFLi/LED	1200/300/300W
Max Relay Current	10A
Detection Distance Max	2,5,8,10m radius adjustable
Installation Height	1.5-4m
Surge Protection	1Kv
Operating Temperature	-35°C to 50°C
Warranty	5 years

SENSITIVITY

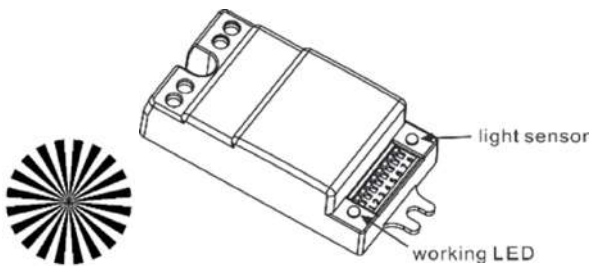

SENS	DELAY TIME			DAYLIGHT LUX				
	1	2	3	4	5	6	7	8
2M	<input type="checkbox"/>	<input type="checkbox"/>	<input type="checkbox"/>	<input type="checkbox"/>	<input type="checkbox"/>	<input type="checkbox"/>	<input type="checkbox"/>	<input type="checkbox"/>
5M	<input type="checkbox"/>	<input type="checkbox"/>	<input type="checkbox"/>	<input type="checkbox"/>	<input type="checkbox"/>	<input type="checkbox"/>	<input type="checkbox"/>	<input type="checkbox"/>
8M	<input type="checkbox"/>	<input type="checkbox"/>	<input type="checkbox"/>	<input type="checkbox"/>	<input type="checkbox"/>	<input type="checkbox"/>	<input type="checkbox"/>	<input type="checkbox"/>
10M	<input type="checkbox"/>	<input type="checkbox"/>	<input type="checkbox"/>	<input type="checkbox"/>	<input type="checkbox"/>	<input type="checkbox"/>	<input type="checkbox"/>	<input type="checkbox"/>
DIP,Switch	<input type="checkbox"/>	<input type="checkbox"/>	<input type="checkbox"/>	<input type="checkbox"/>	<input type="checkbox"/>	<input type="checkbox"/>	<input type="checkbox"/>	<input type="checkbox"/>

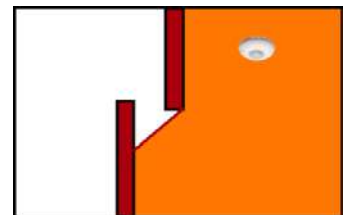

ORDERING CODES - MICROWAVE MOTION SENSORS

VALUE
CLASS

30000h

LEDVANCE
5 year
guarantee

Product Name

EAN10

Model Number



MICROWAVE MOTION SENSOR FOR RECESSED MOUNTING

Product Name	EAN10	Model Number	CUT OUT (mm)	L (mm)	w (mm)	h (mm)	Person
MS-SV-MIC-CR-360-230V-IP20 10X1 LEDV	4058075373099	LEDSENSORMICR360	Ø61.5	80	61.5	76	90.5
MS-SV-MIC-CR-A-360-230V-IP20 10X1 LEDV	4058075373112	LEDSENSORMICRA360	Ø61.5	80	80	59	67.4

MICROWAVE MOTION SENSOR FOR BUILT-IN LUMINAIRES

MS-SV-MIC-IL-360-230V-IP20 10X1 LEDV	4058075373136	LDVSENSORMICIL360	-	75	36	25	45.3
--------------------------------------	----------------------	-------------------	---	----	----	----	------

Value Dimmers

The Value Dimmers provide you with optimised dimming of LED drivers and a wide multitude of traditional and LED lamps (dimming level and lamp dependent). With a rotary control for minimum or maximum brightness levels to suit your visual comfort. Suitable for all indoor residential, commercial and hospitality application.

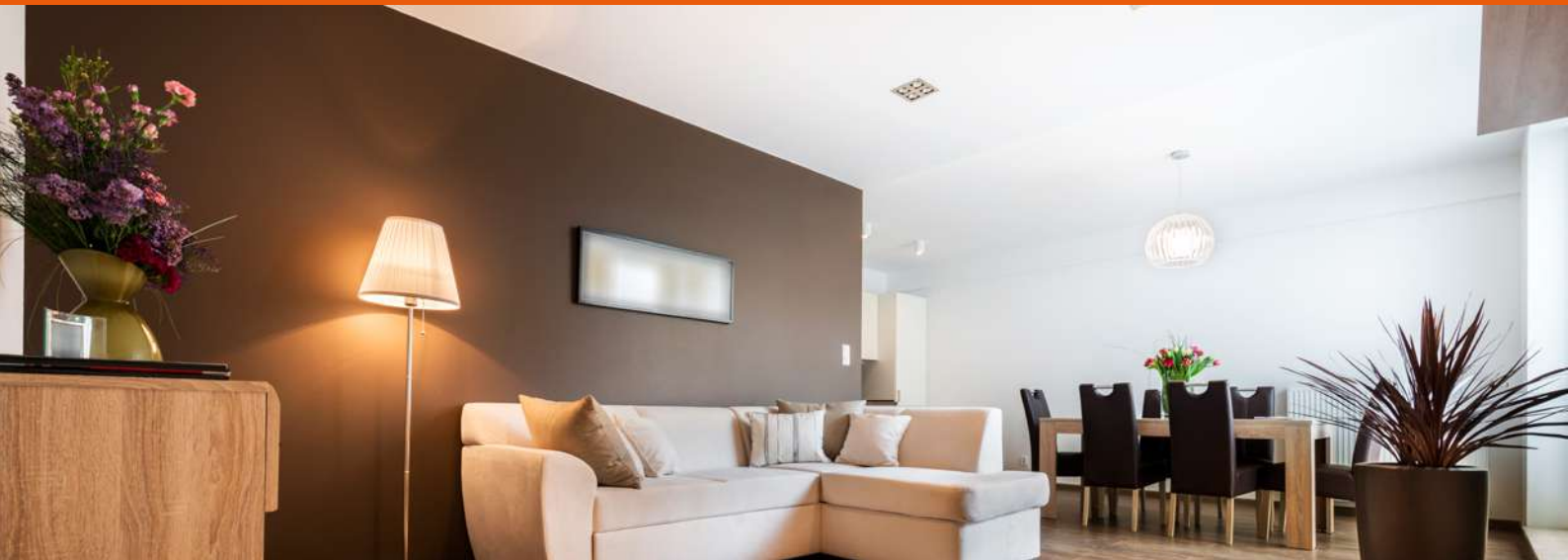

FEATURES AND BENEFITS

- Suitable for lamps or light fixtures with 1-10V drive or universal control
- For indoor applications such as residential, commercial and hospitality

AREAS OF APPLICATION

- Living rooms
- Stairways
- Corridors

SPECIFICATIONS

LDVDIMMER1-10V		LDVDIMMERUNIV	
Dimming Method	1-10V	Dimming Method	Universal
Application Method	1 way	Application Method	1/multi way
Power Supply	DC 1-10V	Power Supply	Live wire
Maximum Load	50mA	Maximum Load	Incandescent: 300W LED/CFL: 150W
Operating Mode	Rotary	Minimum Load	Incandescent: 15W LED/CFL: 3W
Rated Voltage	N/A	Operating Mode	Rotary
Housing Material	Polycarbonate	Rated Voltage	220-240V
Warranty	5 years	Housing Material	Polycarbonate
		Warranty	5 years

DIMENSIONS

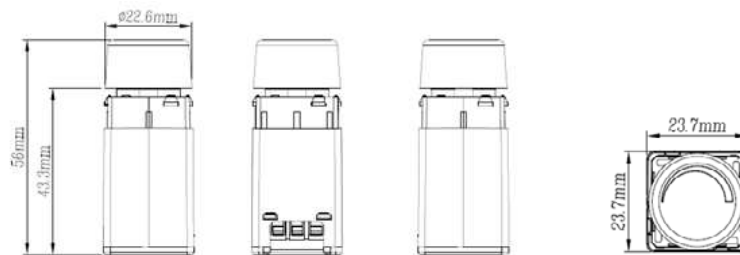

23.7x23.7x56mm

ORDERING CODES - VALUE DIMMERS

VALUE
CLASS

LEDVANCE
5 year
guarantee

Product name	EAN10	Model number						
--------------	-------	--------------	--	--	--	--	--	--

VALUE DIMMERS

MS-DP-1-10V-ROT 50MA 230V 30X1 AU LED	4058075555273	LDVDIMMER1-10V	1-10V	23.7	23.7	56	18
MS-DP-UNIV-ROT 300W 230V 30X1 AU LEDVAU	4058075555259	LDVDIMMERUNIV	UNIVERSAL	23.7	23.7	56	24.5

IP20 Electronic Transformer 60W

The new IP20 Electronic Transformer 60W is the perfect choice for simple operation and installation of low voltage 12V halogen or LED retrofit lamps. With the ability to operate multiple lamp types, it is compact in size, universally dimmable, simple to wire and competitively priced.



FEATURES AND BENEFITS

- Constant voltage 12V LED electronic transformer
- IP20, for indoor application
- Average lifetime up to 35,000 hours
- Supplied with Flex and Plug
- Long lifetime to reduce the maintenance cost
- High Power factor
- Suitable for leading and trailing edge phase cut dimming
- Compact design, easy for installation
- SELV - Safety Extra Low Voltage, more safety application
- Suitable for both halogen and LED MR16 lamps

AREAS OF APPLICATION

- General areas

SPECIFICATIONS

Input Voltage	220-240V AC	PF	>0.95
Frequency	50/60Hz	IP Rating	IP20
Input Current	Max 270mA	Dimmable	Phase-cut dimming
Input Wattage	Max 65W	Connection Type	Input: 1m cable with flex and plug Output: AWG20, 0.24m wires with MR16 socket
Output Wattage (Minimum load)	10W	Operating Temperature	-20 to 50 °C
Output Wattage (Maximum load)	60W	Lifetime	35000 hours
Output Voltage	11-13V AC	Warranty	5 years
Output Current	4-6A		

DIMENSIONS

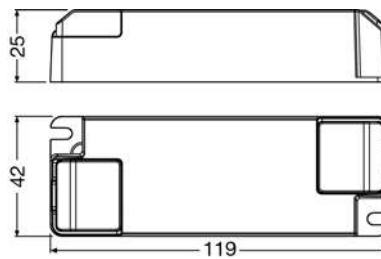

119x42x25mm

ORDERING CODES - IP20 ELECTRONIC TRANSFORMER 60W

VALUE
CLASS



35000h



Product name

EAN10

Model number



IP20 ELECTRONIC TRANSFORMER 60W

LVEDVAL60/220-240/
12DIMVS30PRIM/SECLEDV

4099854089732

OSRLDVD60ECGFP12V

PHASE CUT

119

42

25

171



STREET LIGHTING

Applications: Public spaces | Car parks | Streets and roads | Parks and pedestrian path



ECO SOLAR STREETLIGHT

166



SOLAR STREETLIGHT

170



STREETLIGHT FLEX

174



THESEUS

178

Eco Solar Streetlight

The Eco Solar Streetlight is available in four sizes with four wattages, ranging from 5W to 24W. With a LiFeP04 battery and high grade monocrystalline silicon solar panel, this streetlight is built to meet a variety of lighting needs. The streetlight is designed for easy operation with a remote control provided, and is IP65 rated for durability and long-lasting performance. With a high system efficacy up to 165 lm/W, this streetlight leads to significant energy savings.



FEATURES AND BENEFITS

- 5W, 9W, 18W, 24W
- Single colour in 3000K, 4000K and 6500K
- High efficacy up to 165lm/W
- IP65
- Built in sensor
- Supplied complete with mounting arm
- Remote control supplied
- High grade ABS housing
- LiFeP04 battery charge-discharge cycle 2000 times
- Lamp pole is provided for easy installation
- High grade mono-crystalline silicon solar panel
- Lifetime 20000 hours

AREAS OF APPLICATION

- Public spaces
- Car parks
- Streets and roads
- Rural areas
- Parks and pedestrian path lighting

AVAILABLE SIZES



SPECIFICATIONS

Wattage	5W, 9W, 18W, 24W	SDCM	<6
Lumens	800, 1500, 3000, 4100	Electrical Classification	Class III
lm/W	165	Voltage	4.5V
CCT	3000K, 4000K, 6500K	Remote Control	Supplied
IP Rating	IP65	Mounting Type	Supplied with mounting arm
IK Rating	IK03	Operating Temperature	0°C to 50°C
Sensor	Built-in sensor	Lifetime	20000 hours
Battery	LiFePO4	Warranty	5 years
Housing Material	ABS		
Beam Angle	110°		
CRI	>70		

PHOTOMETRICS

(Example of LDVSST18W740)

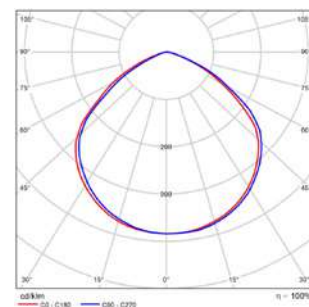

DIMENSIONS

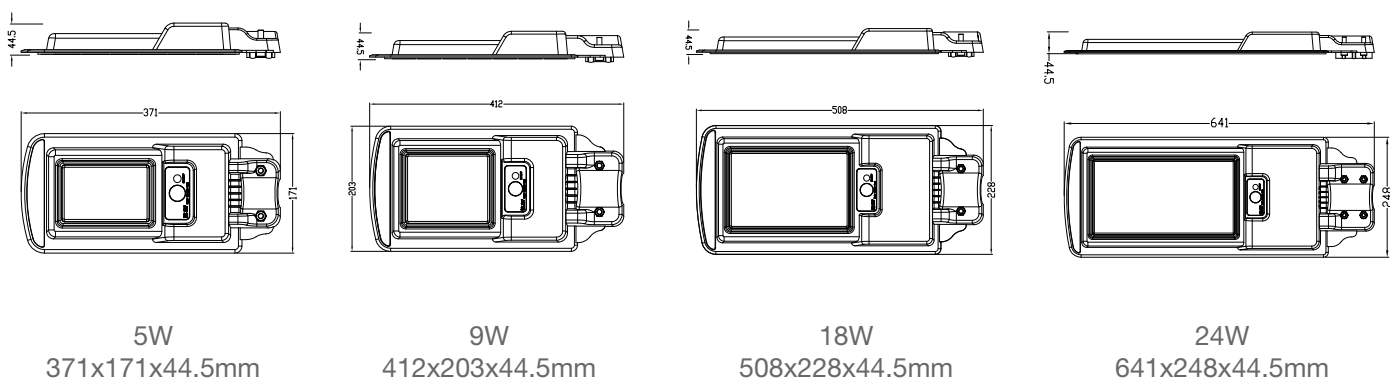

ORDERING CODES - ECO SOLAR STREETLIGHT



Product name	EAN10	Model number	W	lm	K	Δ°	lm/W	h m	L (mm)	W (mm)	h (mm)	
--------------	-------	--------------	---	----	---	----------------	------	--------	-----------	-----------	-----------	--

ECO SOLAR STREETLIGHT

LDECO SOLAR ST MI 80 730 6X1 LEDV	4099854176791	LDVSS5W730	5	800	3000	110	165	6	371	171	44.5	1450
LDECO SOLAR ST MI 80 740 6X1 LEDV	4099854176852	LDVSS5W740	5	800	4000	110	165	6	371	171	44.5	1450
LDECO SOLAR ST MI 80 765 6X1 LEDV	4099854176890	LDVSS5W765	5	800	6500	110	165	6	371	171	44.5	1450
LDECO SOLAR ST SM 150 730 5X1 LEDV	4099854176975	LDVSS9W730	9	1500	3000	110	165	8	412	203	44.5	1820
LDECO SOLAR ST SM 150 740 5X1 LEDV	4099854177019	LDVSS9W740	9	1500	4000	110	165	8	412	203	44.5	1820
LDECO SOLAR ST SM 150 765 5X1 LEDV	4099854177057	LDVSS9W765	9	1500	6500	110	165	8	412	203	44.5	1820
LDECO SOLAR ST MD 300 730 5X1 LEDV	4099854177071	LDVSS18W730	18	3000	3000	110	165	8	508	228	44.5	2360
LDECO SOLAR ST MD 300 740 5X1 LEDV	4099854177118	LDVSS18W740	18	3000	4000	110	165	8	508	228	44.5	2360
LDECO SOLAR ST MD 300 765 5X1 LEDV	4099854177156	LDVSS18W765	18	3000	6500	110	165	8	508	228	44.5	2360
LDECO SOLAR ST LA 400 730 4X1 LEDV	4099854177170	LDVSS24W730	24	4100	3000	110	165	10	641	248	44.5	3120
LDECO SOLAR ST LA 400 740 4X1 LEDV	4099854177217	LDVSS24W740	24	4100	4000	110	165	10	641	248	44.5	3120
LDECO SOLAR ST LA 400 765 4X1 LEDV	4099854177231	LDVSS24W765	24	4100	6500	110	165	10	641	248	44.5	3120



ECO SOLAR STREETLIGHT



Solar Streetlight

The Solar Streetlight is an all-in-one design with no wiring required for a flexible and simple installation. With an extremely high luminous efficacy of 185 lm/W to maximise the battery performance and a rotatable LED module. Grade A bi-facial mono-crystalline solar panel, and an adjustable install arm, multi-angle adjustment, make solar panel easy to apply to sunlight trajectory from different directions. Available in 6 wattages and 3 colour options.



FEATURES AND BENEFITS

- 10W, 20W, 30W, 40W, 50W, 60W
- Single colour in 3000K, 4000K or 5700K
- High efficacy up to 185lm/W
- Beam angles 30°x150°
- IP66
- IK07
- Die-cast aluminium housing
- LiFeP04 battery charge-discharge cycle 2000 times
- Easy to install thanks to the all-in-one design, with no wiring required and an adjustable install arm
- Grade A bi-facial mono crystalline solar panel
- Lifetime 80000 hours

AREAS OF APPLICATION

- Public spaces
- Car parks
- Streets and roads
- Rural areas
- Parks and pedestrian path lighting

AVAILABLE SIZES



10W
Weight: 9.5KG



20W
Weight: 10.9KG



30W
Weight: 12.9KG



40W
Weight: 14.3KG



50W
Weight: 16.5KG



60W
Weight: 17.9KG

SPECIFICATIONS

Wattage	10W, 20W, 30W, 40W, 50W, 60W	CRI	>70
Lumens	1850, 3700, 5550, 7400, 9250, 11100	Electrical Classification	Class I
lm/W	185	PF	>0.9
CCT	3000K, 4000K, 5700K	Frequency	50/60Hz
IP Rating	IP66	Mounting Type	Pole mounting
IK Rating	IK07	Pole Diameter	Spigot Ø60 mm
Sensor	In-built microwave sensor	Operating Temperature	-20°C to 50°C
Housing Material	Die-cast aluminium	Lifetime	80000 hours
Beam Angle	30°x150°	Warranty	5 years

PHOTOMETRICS

(Example of P-SOLST-30-740)

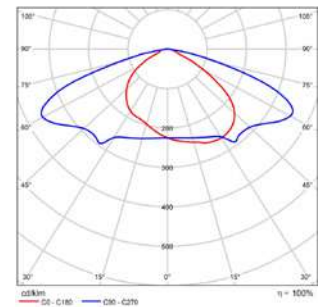

DIMENSIONS

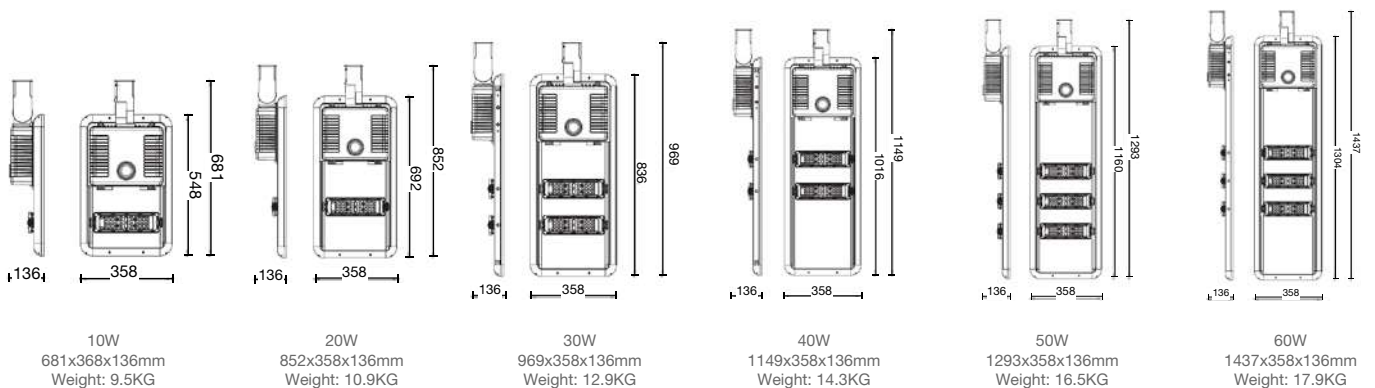

ORDERING CODES - SOLAR STREETLIGHT



Product name	EAN10	Model number	W	lm	K	°	lm/W	h m	L (mm)	W (mm)	h (mm)	Person
--------------	-------	--------------	---	----	---	---	------	--------	-----------	-----------	-----------	--------

STANDARD

LDPFM SOLAR ST 10W 730 VS1 LEDV	4058075562882	P-SOLST-10-730	10	1850	3000	30°X150°	185	5	681	358	136	9500
LDPFM SOLAR ST 10W 740 VS1 LEDV	4058075562912	P-SOLST-10-740	10	1850	4000	30°X150°	185	5	681	358	136	9500
LDPFM SOLAR ST 10W 757 VS1 LEDV	4058075729889	P-SOLST-10-757	10	1850	5700	30°X150°	185	5	681	358	136	9500
LDPFM SOLAR ST 10W 765 VS1 LEDV	4058075562905	P-SOLST-10-765	10	1850	6500	30°X150°	185	5	681	358	136	9500
LDPFM SOLAR ST 20W 730 VS1 LEDV	4058075562929	P-SOLST-20-730	20	3700	3000	30°X150°	185	6	825	358	136	10900
LDPFM SOLAR ST 20W 740 VS1 LEDV	4058075562936	P-SOLST-20-740	20	3700	4000	30°X150°	185	6	825	358	136	10900
LDPFM SOLAR ST 20W 757 VS1 LEDV	4058075729896	P-SOLST-20-757	20	3700	5700	30°X150°	185	6	825	358	136	10900
LDPFM SOLAR ST 20W 765 VS1 LEDV	4058075562943	P-SOLST-20-765	20	3700	6500	30°X150°	185	6	825	358	136	10900
LDPFM SOLAR ST 30W 730 VS1 LEDV	4058075562950	P-SOLST-30-730	30	5550	3000	30°X150°	185	6	969	358	136	12900
LDPFM SOLAR ST 30W 740 VS1 LEDV	4058075562967	P-SOLST-30-740	30	5550	4000	30°X150°	185	6	969	358	136	12900
LDPFM SOLAR ST 30W 757 VS1 LEDV	4058075729902	P-SOLST-30-757	30	5550	5700	30°X150°	185	6	969	358	136	12900
LDPFM SOLAR ST 30W 765 VS1 LEDV	4058075562974	P-SOLST-30-765	30	5550	6500	30°X150°	185	6	969	358	136	12900
LDPFM SOLAR ST 40W 730 VS1 LEDV	4058075562981	P-SOLST-40-730	40	7400	3000	30°X150°	185	8	1149	358	136	14300
LDPFM SOLAR ST 40W 740 VS1 LEDV	4058075562998	P-SOLST-40-740	40	7400	4000	30°X150°	185	8	1149	358	136	14300
LDPFM SOLAR ST 40W 757 VS1 LEDV	4058075729919	P-SOLST-40-757	40	7400	5700	30°X150°	185	8	1149	358	136	14300
LDPFM SOLAR ST 40W 765 VS1 LEDV	4058075563001	P-SOLST-40-765	40	7400	6500	30°X150°	185	8	1149	358	136	14300
LDPFM SOLAR ST 50W 730 VS1 LEDV	4058075563025	P-SOLST-50-730	50	9250	3000	30°X150°	185	10	1293	358	136	16500
LDPFM SOLAR ST 50W 740 VS1 LEDV	4058075563032	P-SOLST-50-740	50	9250	4000	30°X150°	185	10	1293	358	136	16500
LDPFM SOLAR ST 50W 757 VS1 LEDV	4058075729926	P-SOLST-50-757	50	9250	5700	30°X150°	185	10	1293	358	136	16500
LDPFM SOLAR ST 50W 765 VS1 LEDV	4058075563049	P-SOLST-50-765	50	9250	6500	30°X150°	185	10	1293	358	136	16500
LDPFM SOLAR ST 60W 730 VS1 LEDV	4058075563056	P-SOLST-60-730	60	11100	3000	30°X150°	185	10	1437	358	136	17900
LDPFM SOLAR ST 60W 740 VS1 LEDV	4058075563063	P-SOLST-60-740	60	11100	4000	30°X150°	185	10	1437	358	136	17900
LDPFM SOLAR ST 60W 757 VS1 LEDV	4058075729933	P-SOLST-60-757	60	11100	5700	30°X150°	185	10	1437	358	136	17900
LDPFM SOLAR ST 60W 765 VS1 LEDV	4058075563070	P-SOLST-60-765	60	11100	6500	30°X150°	185	10	1437	358	136	17900

ORDERING CODES - SOLAR STREETLIGHT



Product name	EAN10	Model number	W	lm	K	°	lm/W	h m	l (mm)	w (mm)	h (mm)	g
--------------	-------	--------------	---	----	---	---	------	-----	--------	--------	--------	---

MICROWAVE SENSOR

LDPFM SOLAR ST 10W 730 MWS VS1 LEDV	4058075563094	P-SOLST-10-MWS-730	10	1850	3000	30°X150°	185	5	681	358	136	9500
LDPFM SOLAR ST 10W 740 MWS VS1 LEDV	4058075563100	P-SOLST-10-MWS-740	10	1850	4000	30°X150°	185	5	681	358	136	9500
LDPFM SOLAR ST 10W 757 MWS VS1 LEDV	4058075729940	P-SOLST-10-MWS-757	10	1850	5700	30°X150°	185	5	681	358	136	9500
LDPFM SOLAR ST 10W 765 MWS VS1 LEDV	4058075563117	P-SOLST-10-MWS-765	10	1850	6500	30°X150°	185	5	681	358	136	9500
LDPFM SOLAR ST 20W 730 MWS VS1 LEDV	4058075563124	P-SOLST-20-MWS-730	20	3700	3000	30°X150°	185	6	825	358	136	10900
LDPFM SOLAR ST 20W 740 MWS VS1 LEDV	4058075563131	P-SOLST-20-MWS-740	20	3700	4000	30°X150°	185	6	825	358	136	10900
LDPFM SOLAR ST 20W 757 MWS VS1 LEDV	4058075729957	P-SOLST-20-MWS-757	20	3700	5700	30°X150°	185	6	825	358	136	10900
LDPFM SOLAR ST 20W 765 MWS VS1 LEDV	4058075563148	P-SOLST-20-MWS-765	20	3700	6500	30°X150°	185	6	825	358	136	10900
LDPFM SOLAR ST 30W 730 MWS VS1 LEDV	4058075563155	P-SOLST-30-MWS-730	30	5550	3000	30°X150°	185	6	969	358	136	12900
LDPFM SOLAR ST 30W 740 MWS VS1 LEDV	4058075563162	P-SOLST-30-MWS-740	30	5550	4000	30°X150°	185	6	969	358	136	12900
LDPFM SOLAR ST 30W 757 MWS VS1 LEDV	4058075729964	P-SOLST-30-MWS-757	30	5550	5700	30°X150°	185	6	969	358	136	12900
LDPFM SOLAR ST 30W 765 MWS VS1 LEDV	4058075563179	P-SOLST-30-MWS-765	30	5550	6500	30°X150°	185	6	969	358	136	12900
LDPFM SOLAR ST 40W 730 MWS VS1 LEDV	4058075563186	P-SOLST-40-MWS-730	40	7400	3000	30°X150°	185	8	1149	358	136	14300
LDPFM SOLAR ST 40W 740 MWS VS1 LEDV	4058075563193	P-SOLST-40-MWS-740	40	7400	4000	30°X150°	185	8	1149	358	136	14300
LDPFM SOLAR ST 40W 757 MWS VS1 LEDV	4058075729971	P-SOLST-40-MWS-757	40	7400	5700	30°X150°	185	8	1149	358	136	14300
LDPFM SOLAR ST 40W 765 MWS VS1 LEDV	4058075563209	P-SOLST-40-MWS-765	40	7400	6500	30°X150°	185	8	1149	358	136	14300
LDPFM SOLAR ST 50W 730 MWS VS1 LEDV	4058075563216	P-SOLST-50-MWS-730	50	9250	3000	30°X150°	185	8	1293	358	136	16500
LDPFM SOLAR ST 50W 740 MWS VS1 LEDV	4058075563223	P-SOLST-50-MWS-740	50	9250	4000	30°X150°	185	8	1293	358	136	16500
LDPFM SOLAR ST 50W 757 MWS VS1 LEDV	4058075729988	P-SOLST-50-MWS-757	50	9250	5700	30°X150°	185	8	1293	358	136	16500
LDPFM SOLAR ST 50W 765 MWS VS1 LEDV	4058075563230	P-SOLST-50-MWS-765	50	9250	6500	30°X150°	185	8	1293	358	136	16500
LDPFM SOLAR ST 60W 730 MWS VS1 LEDV	4058075563247	P-SOLST-60-MWS-730	60	11100	3000	30°X150°	185	8	1437	358	136	17900
LDPFM SOLAR ST 60W 740 MWS VS1 LEDV	4058075563254	P-SOLST-60-MWS-740	60	11100	4000	30°X150°	185	8	1437	358	136	17900
LDPFM SOLAR ST 60W 757 MWS VS1 LEDV	4058075729995	P-SOLST-60-MWS-757	60	11100	5700	30°X150°	185	8	1437	358	136	17900
LDPFM SOLAR ST 60W 765 MWS VS1 LEDV	4058075563261	P-SOLST-60-MWS-765	60	11100	6500	30°X150°	185	8	1437	358	136	17900

Streetlight Flex

Streetlight Flex has a sleek design, perfect for any application. The streetlight also has 10KV surge protection and a replaceable SPD, with a high efficacy up to 140 lm/W. For IP66 and IK08 rating it can withstand even the toughest weather conditions, making it a durable choice. It has professional lighting distribution optics and performs exceptionally well across a wide range of geometries. The high-grade die-cast aluminium housing ensures reliable operation.



FEATURES AND BENEFITS

- 21W, 42W, 72W, 90W, 120W, 179W, 210W, 256W, 300W, 320W
- 4 size options: Mini, Small, Medium, Large
- Single colour in 5700K
- High efficacy up to 140lm/W
- RW30 beam angles
- IP66
- IK08
- Die cast aluminium housing
- Lifetime 100000 hours

AREAS OF APPLICATION

- Public spaces
- Car parks
- Streets and roads
- Rural areas
- Parks and pedestrian path lighting

AVAILABLE SIZES



Mini
21W, 42W, 72W
560x250x102mm



Small
90W, 120W
610x250x102mm



Medium
179W, 210W
732x300x102mm



Large
256W, 300W, 320W
890x330x102mm

ACCESSORIES (SOLD SEPARATELY)

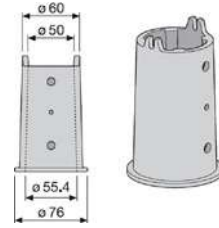

Pole reduction
Ø60 to Ø42mm

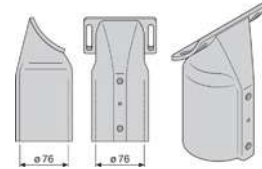

Pole adapter
Ø75mm

SPECIFICATIONS

Wattage	21W, 42W, 72W, 90W, 120W, 179W, 210W, 256W, 300W, 320W	Electrical Classification	Class I
Lumens	2940, 5880, 10080, 12600, 16800, 25060, 29400, 35840, 42000, 44800	Voltage	120-277V AC
lm/W	140	PF	>0.9
CCT	5700K	Frequency	50/60Hz
IP Rating	IP66	Surge Protection	10KV(L-N) Inbuilt driver: 5KV(L-N) 10KV(L/N-PE)
IK Rating	IK08	Mounting Type	Side entry/Post top
Housing Material	Die cast aluminium Stainless steel screws	Operating Temperature	-30°C to 50°C
Beam Angle	RW30	Pole diameter	Standard Ø60mm Accessories: Ø42mm, Ø75mm
CRI	>70	Lifetime	100000 hours
SDCM	<5	Warranty	5 years

PHOTOMETRICS

(Example of LDVSTFX320W757)

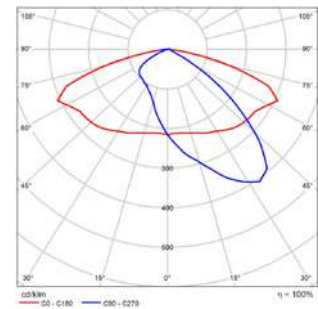

DIMENSIONS

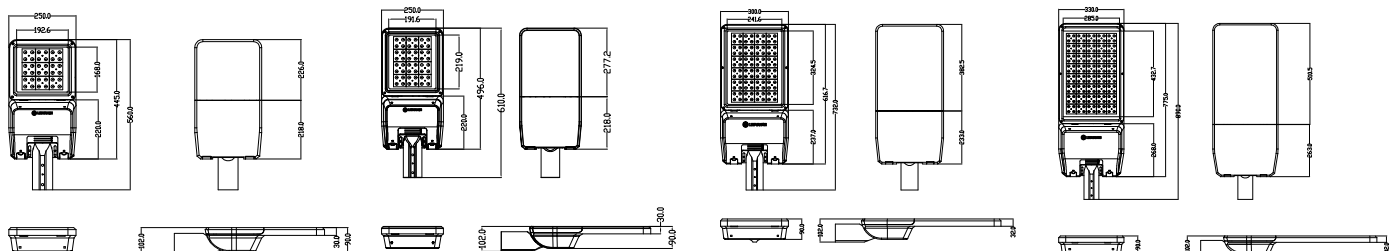

21W, 42W, 72W
560x250x102mm

90W, 120W
610x250x102mm

179W, 210W
732x300x102mm

256W, 300W, 320W
890x330x102mm

ORDERING CODES - STREETLIGHT FLEX



Product name	EAN10	Model number	W	lm	K	Δ	lm/W	l (mm)	w (mm)	h (mm)	
--------------	-------	--------------	---	----	---	----------	------	--------	--------	--------	--

STANDARD

LDPFM ST MP MI 21W 757 RW30 2870N VS1LEDV	4099854162145	LDVSTFX21W757	21	2940	5700	RW30	140	560	250	102	4800
LDPFM ST MP MI 42W 757 RW30 5470N VS1LEDV	4099854162176	LDVSTFX42W757	42	5880	5700	RW30	140	560	250	102	4800
LDPFM ST MP MI 72W 757 RW30 9670N VS1LEDV	4099854162190	LDVSTFX72W757	72	10080	5700	RW30	140	560	250	102	5000
LDPFM ST MP SM 90W 757 RW30 12070N VS1LEDV	4099854162213	LDVSTFX90W757	90	12600	5700	RW30	140	610	250	102	5500
LDPFM ST MP SM 120W 757 RW30 15070N VS1LEDV	4099854162237	LDVSTFX120W757	120	16800	5700	RW30	140	610	250	102	5600
LDPFM ST MP MD 179W 757 RW30 23070N VS1LEDV	4099854162251	LDVSTFX179W757	179	25060	5700	RW30	140	732	300	102	8100
LDPFM ST MP MD 210W 757 RW30 27670N VS1LEDV	4099854162275	LDVSTFX210W757	210	29400	5700	RW30	140	732	300	102	8100
LDPFM ST MP LA 256W 757 RW30 36070N VS1LEDV	4099854162299	LDVSTFX256W757	256	35840	5700	RW30	140	890	330	102	11500
LDPFM ST MP LA 300W 757 RW30 39670N VS1LEDV	4099854162329	LDVSTFX300W757	300	42000	5700	RW30	140	890	330	102	11700
LDPFM ST MP LA 320W 757 RW30 43270N VS1LEDV	4099854162343	LDVSTFX320W757	320	44800	5700	RW30	140	890	330	102	11700

Product name	EAN10	Model number	l (mm)	d (mm)
--------------	-------	--------------	--------	--------

SPIGOT

SL FLEX SPIGOT 76MM WAL	4058075552531	LDVSTFXS76	191	76
SL FLEX REDUCTION 60 TO 42MM WAL	4058075552579	LDVSTFXS42	122	76

STREETLIGHT FLEX



STREETLIGHT FLEX

Theseus

The Theseus is an extremely energy efficient street light of up to 140 lm/W. Available in a wide range of wattages from 30W to 150W. With excellent heat dissipation, the Theseus is a reliable fitting and modern in its design. Suitable for a range of outdoor applications such as street and pathway lighting, car parks, stadiums and airports, and with the optional daylight and motion sensor you can potentially enhance power savings and reduce unwanted light pollution.



FEATURES AND BENEFITS

- 30W, 50W, 60W, 100W, 150W
- Single colour in 4000K and 5700K*
- High efficacy up to 140lm/W
- Beam angles 30°x150°
- IP65
- IK10
- Aluminium housing with 4mm tempered glass
- Lifetime 100000 hours

AREAS OF APPLICATION

- Public spaces
- Car parks
- Streets and roads
- Rural areas
- Parks and pedestrian path lighting

AVAILABLE SIZES



508x180x109mm
Weight: 5KG



558x258x105mm
Weight: 6.7KG



608x300x105mm
Weight: 8.2KG

ACCESSORIES (SOLD SEPARATELY)



42-60mm Spigot



60mm Spigot



76mm Spigot

SPECIFICATIONS

Wattage	30W, 50W, 60W, 100W, 150W	Voltage	100-277V
Lumens	3900, 6500, 8100, 13500, 19500	PF	>0.9
lm/W	140	Frequency	50/60Hz
CCT*	4000K, 5700K	Surge Protection	10KV
IP Rating	IP65	Mounting Type	Pole mounting
IK Rating	IK10	Pole Diameter**	Ø42mm, Ø60mm, Ø76mm
Dimmable	0-10V, DALI, PWM	Operating Temperature	-40°C to 40°C
Sensor	All leading motion or daylight sensors	Lifetime	100000 hours
Housing Material	Aluminium/glass	Warranty	5 years
Beam Angle	40°x140°, 50°x140°	* Other options available, made to order	
CRI	>70	**Spigots sold separately	
Electrical Classification	Class II		

PHOTOMETRICS

(Example of 400-T68-40W T2)

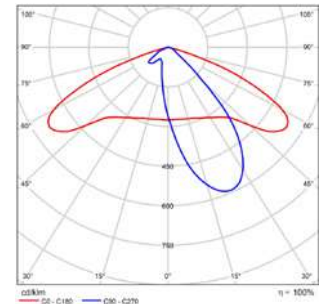

(Example of 400-T68-50W T3)

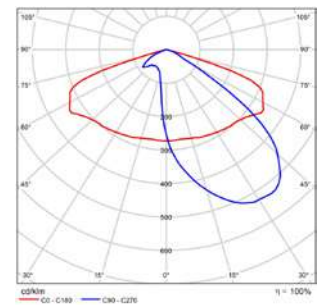

DIMENSIONS

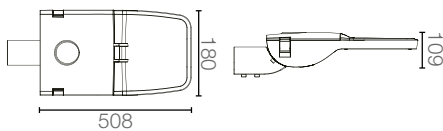

508x180x109mm
Weight: 5KG

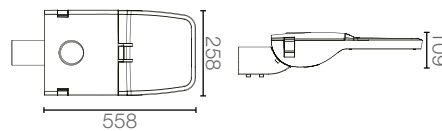

558x258x105mm
Weight: 6.7KG

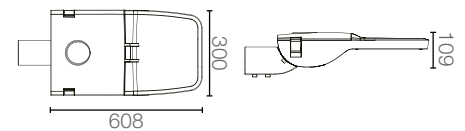

608x300x105mm
Weight: 8.2KG

TECHNICAL DATA - THESEUS

Product name	W	V	lm	lm/W	$\frac{l}{(mm)}$	$\frac{w}{(mm)}$	$\frac{h}{(mm)}$	
LDV-T68-ST-030	30	100-277V / 240-480V	3900	3900	508	180	109	5000
LDV-T68-ST-040	40	100-277V / 240-480V	5600	5600	508	180	109	5000
LDV-T68-ST-050	50	100-277V / 240-480V	6500	6500	508	180	109	5000
LDV-T68-ST-060	60	100-277V / 240-480V	8100	8100	558	258	105	6700
LDV-T68-ST-080	80	100-277V / 240-480V	10400	10400	558	258	105	6700
LDV-T68-ST-100	100	100-277V / 240-480V	13500	13500	608	300	105	8200
LDV-T68-ST-120	120	100-277V / 240-480V	15600	15600	608	300	105	8200
LDV-T68-ST-150	150	100-277V / 240-480V	19500	19500	608	300	105	8400

ORDERING CODES - THESEUS



Product ID	LED Wattage	Colour Temperature	CRI	Optics	Control	Extras
------------	-------------	--------------------	-----	--------	---------	--------

THESEUS - MADE TO ORDER

T68-ST	030 = 30W	30K = 3000K	70 = MIN 70	T2 = TYPE II (50° X 140°)	ND = NON DIMMABLE	
	040 = 40W	40K = 4000K		T3 = TYPE III (40° X 140°)	VD = 0-10V DIMMABLE	
	050 = 50W	50K = 5000K			DD = DALI DIMMABLE	
	060 = 60W	60K = 6000K				
	080 = 80W					
	100 = 100W					
	120 = 120W					
	150 = 150W					

Product name	EAN10	Model number			
--------------	-------	--------------	--	--	--

SPIGOT

LDPFM SL THESEUS SPIGOT 42MM 12X1 LEDV	4058075486249	LDVT68S42	80	55	810
LDPFM SL THESEUS SPIGOT 60MM 12X1 LEDV	4058075486263	LDVT68S60	160	62	640
LDPFM SL THESEUS SPIGOT 76MM 12X1 LEDV	4058075486287	LDVT68S76	190	80	960



TRADITIONAL LAMP



COMPACT FLUORESCENT LAMP

184



FLUORESCENT LAMP

189



METAL HALIDE LAMP

193



HIGH PRESSURE SODIUM LAMP

195



INCANDESCENT LAMP

197



HALOGEN LAMP

198



INFRARED LAMP

202

ORDERING CODES - COMPACT FLUORESCENT LAMP



Product Name	EAN	Model Number	No.	W	mm	lm	K	Ra	V	mm	d (mm)	t (mm)
--------------	-----	--------------	-----	---	----	----	---	----	---	----	--------	--------

DULUX® D











DULUX D 13W/830 G24D-1	4008321830791	OSRDULUXD13W/827	01	13	G24D-1	900	3000	80	91	×	138	11	10000
DULUX D 13W/840 G24D-1	4008321830814	OSRDULUXD13W/840	01	13	G24D-1	900	4000	80	91	×	138	11	10000
DULUX D 18W/830 G24D-2	4008321830876	OSRDULUXD18W/830	02	18	G24D-2	1200	3000	80	100	×	153	12	10000
DULUX D 18W/840 G24D-2	4008321830890	OSRDULUXD18W/840	02	18	G24D-2	1200	4000	80	100	×	153	11	10000
DULUX D 26W/830 G24D-3	4008321830951	OSRDULUXD26W/830	03	26	G24D-3	1800	3000	80	105	×	172	13	10000
DULUX D 26W/840 G24D-3	4008321830975	OSRDULUXD26W/840	03	26	G24D-3	1800	4000	80	105	×	172	13	10000

DULUX® D/E

DULUX D/E 13W/840 G24Q-1	4008321830357	OSRDULUXD/E13W/840	04	13	G24Q-1	900	4000	80	77	×	131	12	10000
DULUX D/E 18W/830 G24Q-2	4008321830418	OSRDULUXD/E18W/830	05	18	G24Q-2	1200	3000	80	80	×	146	12	10000
DULUX D/E 18W/840 G24Q-2	4008321830432	OSRDULUXD/E18W/840	05	18	G24Q-2	1200	4000	80	80	×	146	12	10000
DULUX D/E 18W/865 G24Q-2	4008321830456	OSRDULUXD/E18W/865	05	18	G24Q-2	1140	6500	80	80	×	146	12	10000
DULUX D/E 26W/830 G24Q-3	4008321830494	OSRDULUXD/E26W/830	06	26	G24Q-3	1800	3000	80	80	×	165	12	20000
DULUX D/E 26W/840 G24Q-3	4008321830517	OSRDULUXD/E26W/840	06	26	G24Q-3	1800	4000	80	80	×	165	12	10000

ORDERING CODES - COMPACT FLUORESCENT LAMP



Product Name	EAN	Model Number	 No.	 W	 E	 lm	 K	 Ra	 V		 L (mm)	 d (mm)	 t (h)
DULUX® L LUMILUX®													
DULUX L 18W/840 2G11	4050300010724	OSRDULUXL18W/840	01	18	2G11	1175	4000	80	58	✓	221	18	20000
DULUX L 24W/830 2G11	4050300010762	OSRDULUXL24W/830	02	24	2G11	1620	3000	80	87	✓	321	18	20000
DULUX L 24W/840 2G11	4050300010755	OSRDULUXL24W/840	02	24	2G11	1620	4000	80	87	✓	321	18	20000
DULUX L 36W/830 2G11	4050300010793	OSRDULUXL36W/830	03	36	2G11	2600	3000	80	106	✓	415	18	20000
DULUX L 36W/840 2G11	4050300010786	OSRDULUXL36W/840	03	36	2G11	2600	4000	80	106	✓	415	18	20000
DULUX L 40W/830 2G11	4050300298894	OSRDULUXL40W/830	04	40	2G11	3150	3000	80	126	✓	538	18	20000
DULUX L 40W/840 2G11	4050300279909	OSRDULUXL40W/840	04	40	2G11	3150	4000	80	126	✓	538	18	20000
DULUX L 55W/840 2G11	4050300295879	OSRDULUXL55W/840	04	55	2G11	4320	4000	80	101	✓	538	18	20000

ORDERING CODES - COMPACT FLUORESCENT LAMP



Product Name	EAN	Model Number	No.	W	mm	lm	K	Ra	V	mm	mm	t(h)
--------------	-----	--------------	-----	---	----	----	---	----	---	----	----	------

DULUX® S

DULUX S 7W/827 G23	4050300005997	OSRDULUXS7W/827	01	7	G23	400	2700	80	47	×	137	12	10000
DULUX S 7W/840 G23	4008321664273	OSRDULUXS7W/840EN	01	7	G23	400	4000	80	47	×	137	12	8000
DULUX S 9W/830 G23	4050300025742	OSRDULUXS9W/830	02	9	G23	600	3000	80	60	×	167	12	10000
DULUX S 9W/840 G23	4008321664310	OSRDULUXS9W/840EN	02	9	G23	600	840	80	60	×	167	12	8000
DULUX S 11W/827 G23	4050300006017	OSRDULUXS11W/827	03	11	G23	900	2700	80	91	×	237	12	10000
DULUX S 11W/840 G23	4008321664358	OSRDULUXS11W/840EN	03	11	G23	900	840	80	91	×	237	12	8000

DULUX® T PLUS

DULUX T 13W/830 PLUS GX24D	4050300446929	OSRDULUXT13W/830	04	13	GX24D-1	850	3000	80	91	×	114	11	10000
DULUX T 13W/840 PLUS GX24D	4050300446905	OSRDULUXT13W/840	04	13	GX24D-1	850	4000	80	91	×	114	11	10000
DULUX T 26W/830 PLUS GX24D	4050300342061	OSRDULUXT26W/830	05	26	GX24D-3	1800	3000	80	105	×	139	12	10000
DULUX T 26W/840 PLUS GX24D	4050300342047	OSRDULUXT26W/840	05	26	GX24D-3	1800	4000	80	105	×	139	12	10000

ORDERING CODES - COMPACT FLUORESCENT LAMP



Product Name	EAN	Model Number	No.	W	mm	lm	K	Ra	V	mm	mm	mm	t(h)
--------------	-----	--------------	-----	---	----	----	---	----	---	----	----	----	------

DULUX® T/E PLUS

DULUX T/E 13W/840 PLUS GX24Q	4050300446967	OSRDULUXT/E13W/840	01	13	GX24Q-1	850	4000	80	93	✓	107	11	20000
DULUX T/E 18W/840 PLUS GX24Q	4050300342221	OSRDULUXT/E18W/840	02	18	GX24Q-2	1200	4000	80	100	✓	117	12	20000
DULUX T/E 26W/830 PLUS GX24Q	4050300342306	OSRDULUXT/E26W/830	03	26	GX24Q-3	1750	3000	80	105	✓	132	12	20000
DULUX T/E 26W/840 PLUS GX24Q	4050300342283	OSRDULUXT/E26W/840	03	26	GX24Q-3	1750	4000	80	105	✓	132	12	20000
DULUX T/E 32W/830 PLUS GX24Q	4050300348582	OSRDULUXT/E32W/830	04	32	GX24Q-3	2250	3000	80	100	✓	148	12	20000
DULUX T/E 32W/840 PLUS GX24Q	4050300348568	OSRDULUXT/E32W/840	04	32	GX24Q-3	2250	4000	80	100	✓	148	12	20000
DULUX T/E 42W/830 PLUS GX24Q	4050300425641	OSRDULUXT/E42W/830	05	42	GX24Q-4	3050	3000	80	135	✓	169	12	20000
DULUX T/E 42W/840 PLUS GX24Q	4050300425627	OSRDULUXT/E42W/840	05	42	GX24Q-4	3050	4000	80	135	✓	169	12	20000

ORDERING CODES - COMPACT FLUORESCENT LAMP



Product Name	EAN	Model Number	No.	W	mm	lm	K	Ra	V	mm	mm	t(h)	
LUMILUX® T5 FC®													
FC 40W/840 2GX13	4050300528526	OSRFC40W/840	01	40	2GX13	3300	4000	80	126	✓	315	16	12000
FC 55W/840 2GX13	4050300528588	OSRFC55W/840	01	55	2GX13	4250	4000	80	101	✓	315	16	12000
ENERGY SAVER T5 FC®													
T5C 22W/827 C GZ10Q	4008321532886	OSRT5C22W/827	02	22	GZ10Q	1694	2700	80	68	✗	185	16	8000
T5C 22W/840 C GZ10Q	4008321533067	OSRT5C22W/840	02	22	GZ10Q	1694	4000	80	68	✗	185	16	8000
T5C 32W/840 C GZ10Q	4008321533227	OSRT5C32W/840	02	32	GZ10Q	2464	4000	80	86	✗	244	16	8000
T5C 32W/865 C GZ10Q	4008321533241	OSRT5C32W/865	02	32	GZ10Q	2464	6500	80	86	✗	244	16	8000
T5C 40W/840 C GZ10Q	4008321533142	OSRT5C40W/840	02	40	GZ10Q	3080	4000	80	88	✗	275	16	8000
T5C 40W/865 C GZ10Q	4008321533166	OSRT5C40W/865	02	40	GZ10Q	3080	6500	80	88	✗	275	16	8000
LUMILUX® T9 C													
L 22W/840 C G10Q	4008321581082	OSRL22/840C	03	22	G10Q	1250	4000	80	62	✓	209	29	9000
L 22W/865 C G10Q	4008321581105	OSRL22W/865C	03	22	G10Q	1150	6500	80	62	✓	209	29	9000
L 32W/840 C G10Q	4008321530769	OSRL32W/840C	03	32	G10Q	2100	4000	80	84	✓	305	29	9000
L 32W/865 C G10Q	4008321530783	OSRL32W/865C	03	32	G10Q	2000	6500	80	84	✓	305	29	9000
L 40W/840 C G10Q	4008321646149	OSRL40W/840C	03	40	G10Q	3000	4000	80	115	✓	406	29	10000

ORDERING CODES - FLUORESCENT LAMP



01

Product Name	EAN	Model Number	No.	W	mm	lm	K	Ra	V	h	mm	d (mm)	t (h)
LUMILUX® T5 SHORT													
L 4W/640	4050300008875	OSRL4/740	01	4	G5	140	4000	60	29	✓	150	16	6000
L 6W/640	4050300008899	OSRL6/740	01	6	G5	270	4000	60	42	✓	226	16	10000
L 8W/640	4050300008912	OSRL8/740	01	8	G5	385	4000	60	56	✓	303	16	10000
L 8W/827	4050300008943	OSRL8/827	01	8	G5	420	2700	80	56	✓	303	16	10000
L 13W/640	4050300008974	OSRL13/640	01	13	G5	830	4000	60	95	✓	531	16	10000
L 13W/827	4050300008967	OSRL13/827	01	13	G5	950	2700	80	95	✓	531	16	10000
L 13W/840	4050300241647	OSRL13/840	01	13	G5	920	4000	80	95	✓	531	16	10000
SMARTLUX® T5 HE®													
HE 14W/830 SL	4008321335180	OSRT5HE14W830SL	01	14	G5	1200	3000	80	220	✓	549	16	20000
HE 14W/840 SL	4008321335203	OSRT5HE14W840SL	01	14	G5	1200	4000	80	220	✓	549	16	20000
HE 14W/865 SL	4008321335289	OSRT5HE14W865SL	01	14	G5	1100	6500	80	220	✓	549	16	20000
HE 21W/830 SL	4008321335463	OSRT5HE21W830SL	01	21	G5	1900	3000	80	220	✓	849	16	20000
HE 21W/840 SL	4008321335487	OSRT5HE21W840SL	01	21	G5	1900	4000	80	220	✓	849	16	20000
HE 21W/865 SL	4008321335524	OSRT5HE21W865SL	01	21	G5	1750	6500	80	220	✓	849	16	20000
HE 28W/830 SL	4008321335562	OSRT5HE28W830SL	01	28	G5	2600	3000	80	220	✓	1149	16	20000
HE 28W/840 SL	4008321335586	OSRT5HE28W840SL	01	28	G5	2600	4000	80	220	✓	1149	16	20000
HE 28W/865 SL	4008321335623	OSRT5HE28W865SL	01	28	G5	2400	6500	80	220	✓	1149	16	20000
HE 35W/830 SL	4008321335661	OSRT5HE35W830SL	01	35	G5	3320	3000	80	220	✓	1449	16	20000
HE 35W/840 SL	4008321335685	OSRT5HE35W840SL	01	35	G5	3320	4000	80	220	✓	1449	16	20000
HE 35W/865 SL	4008321335722	OSRT5HE35W865SL	01	35	G5	3050	6500	80	220	✓	1449	16	20000

ORDERING CODES - FLUORESCENT LAMP













01

Product Name	EAN	Model Number	No.	W	mm	lm	K	Ra	V	h	mm	Ø (mm)	t (h)
LUMILUX® T5 HO													
HO 24W/830	4050300591667	OSRFQ24W/830	01	24	G5	2000	3000	80	77	✓	563	16	24000
HO 24W/840	4050300591643	OSRFQ24W/840	01	24	G5	2000	4000	80	77	✓	563	16	24000
HO 24W/865	4050300591629	OSRFQ24W/865	01	24	G5	1900	6500	80	77	✓	563	16	24000
HO 24W/940	4008321233028	OSRH024W/940	01	24	G5	1570	4000	90	77	✓	563	16	24000
HO 39W/840	4050300591704	OSRFQ39W/840	01	39	G5	3400	4000	80	118	✓	863	16	24000
HO 49W/840	4050300796710	OSRFQ49W/840	01	49	G5	4800	4000	80	195	✓	1463	16	24000
HO 49W/865	4050300796628	OSRFQ49W/865	01	49	G5	4500	6500	80	195	✓	1463	16	24000
HO 54W/830	4050300591605	OSRFQ54W/830	01	54	G5	5000	3000	80	120	✓	1163	16	24000
HO 54W/840	4050300591582	OSRFQ54W/840	01	54	G5	5000	4000	80	120	✓	1163	16	24000
HO 54W/865	4050300591568	OSRFQ54W/865	01	54	G5	4750	6500	80	120	✓	1163	16	24000
HO 80W/830	4050300591827	OSRFQ80W/830	01	80	G5	7000	3000	80	152	✓	1463	16	24000
HO 80W/840	4050300591841	OSRFQ80W/840	01	80	G5	7000	4000	80	152	✓	1463	16	24000
HO 80W/865	4050300591803	OSRFQ80W/865	01	80	G5	6650	6500	80	152	✓	1463	16	24000

ORDERING CODES - FLUORESCENT LAMP



01

Product Name	EAN	Model Number	 No.	 W		 lm	 K	 Ra	 V		 L (mm)	 Ø d (mm)	 t (h)
LUMILUX® T8													
L 10W/640	4050300179346	OSRL10/640	01	10	G13	930	4000	60	46	✓	346	26	5000
L 18W/830	4008321691187	OSRL18/830	01	18	G13	1674	3000	80	220	✓	600	26	20000
L 18W/840	4008321691200	OSRL18/840	01	18	G13	1674	4000	80	220	✓	600	26	20000
L 18W/865	4008321691224	OSRL18/865	01	18	G13	1674	6500	80	220	✓	600	26	20000
L 30W/840	4008321013743	OSRL30/840	01	30	G13	2790	4000	80	220	✓	895	26	20000
L 30W/865	4008321013767	OSRL30/865	01	30	G13	2790	6500	80	220	✓	895	26	20000
L 36W/830	4008321691125	OSRL36/830	01	36	G13	3348	3000	80	220	✓	1200	26	20000
L 36W/840	4008321691149	OSRL36/840	01	36	G13	3350	4000	80	220	✓	1200	26	20000
L 36W/850	4008321164957	OSRL36/850	01	36	G13	3300	5400	80	220	✓	1200	26	20000
L 36W/865	4008321691163	OSRL36/865	01	36	G13	3250	6500	80	220	✓	1200	26	20000
L 36W/940	4050300011301	OSRL36W/940	01	36	G13	2900	4000	90	220	✓	1200	26	20000
L 58W/840	4008321691088	OSRL58/840	01	58	G13	5200	4000	80	220	✓	1500	26	20000
L 58W/865	4008321691101	OSRL58/865	01	58	G13	5000	6500	80	220	✓	1500	26	20000

ORDERING CODES - FLUORESCENT LAMP



Product Name	EAN	Model Number	No.	W	mm	lm	K	Ra	V	mm	mm	t(h)
--------------	-----	--------------	-----	---	----	----	---	----	---	----	----	------

NATURA® T8 FOOD DISPLAY - BUTCHER LAMP

L 18W/76	4050300010519	OSRL18/76	01	18	G13	750	-	-	57	✓	604	26	20000
L 36W/76	4050300010526	OSRL36/76	01	36	G13	1800	-	-	103	✓	1214	26	20000
L 58W/76	4050300010533	OSRL58/76	01	58	G13	2850	-	-	110	✓	1514	26	20000

BIOLUX® T8 ANIMALS / NATURAL SUNLIGHT

L 36W/965 BIOLUX	4050300270821	OSRL36/965	01	36	G13	2300	6500	95	103	✓	1214	26	20000
------------------	---------------	------------	----	----	-----	------	------	----	-----	---	------	----	-------

FLUORA® T8 PLANT GROWTH

L 36W/77	4050300003184	OSRL36/77	01	36	G13	1400	-	-	103	✓	1214	26	20000
----------	---------------	-----------	----	----	-----	------	---	---	-----	---	------	----	-------

STARTERS

ST 111 BASIC 4-65W / 220-240	4050300854045	OSRST111	02	65	-	-	-	-	220-240	✗	40	22	-
ST 151 BASIC 4-22W / 220-240	4050300854083	OSRST151	03	22	-	-	-	-	220-240	✗	40	22	-

ORDERING CODES - METAL HALIDE LAMP



Product Name	EAN	Model Number	No.	W	mm	lm	K	Ra	V	h	mm	mm	t(h)
POWERARC MI													
MI 250W/U ED28 CLEAR E40	4058075471689	OSRMI250WUE40G2	01	250	E40	21500	4000	65	133	×	210	88	8000
MI 250W/U ED28 COATED E40	4058075471665	OSRMI250WCUE40G2	02	250	E40	19000	3700	70	133	×	210	88	8000
MI 400W/U ED37 CLEAR E40	4058075471313	OSRMI400WUE40G2	01	400	E40	36000	4000	65	135	×	279	116	15000
MI 400W/U ED37 COATED E40	4058075471290	OSRMI400WCUE40G2	02	400	E40	36000	3700	70	135	×	279	116	15000
POWERSTAR HQI®-T													
HQI-T 250W/N/SI/ CLEAR E40	4008321278487	OSRHQI-T250WN/SI/CL	03	250	E40	20000	4500	65	220	×	226	49	10000
HQI-T 250W/D PRO E40 12X1 E/ZH OSRAM	4008321628640	OSRHQI-T250W/D	03	250	E40	19100	5500	87	98	×	226	46	16000
HQI-BT 400W/D PRO E40 12X1 EN/ZH OSRAM	4008321628688	OSRHQI-BT400W/D	04	400	E40	34000	5500	92	115	×	285	62	16000
POWERSTAR HQI®-T 1000...2000W													
HQI-T 1000W/D E40	4008321527035	OSRHQI-T1000D	05	1000	E40	85000	7250	81	130	×	345	76	9000
HQI-T 1000W/N E40	4058075388413	OSRHQI-T1000N	05	1000	E40	110000	3350	64	130	×	345	82	9000
HQI-T 2000W/D E40	4008321526809	OSRHQI-T2000W/D	05	2000	E40	180000	7250	80	230	×	430	106	9000
HQI-T 2000W/D/I E40	4008321527011	OSRHQI-T2000W/D/I	05	2000	E40	180000	7450	83	230	×	430	106	9000
HQI-T 2000W/N/E SUPER E40	4008321979063	OSRHQI-T2000W/N/E	05	2000	E40	245000	4550	63	220	×	430	106	5500
HQI-T 2000W/N/I E40	4008321665379	OSRHQI-T2000W/N/I	05	2000	E40	200000	4300	60	235	×	430	106	9000

ORDERING CODES - METAL HALIDE LAMP



Product Name	EAN	Model Number	No.	W	mm	lm	K	Ra	V	mm	mm	t(h)
--------------	-----	--------------	-----	---	----	----	---	----	---	----	----	------

POWERSTAR HQI®-TS

HQI-TS 1000W/D/S PRO K12S	4008321525475	OSRHQI-TS1000D/SPRO	01	1000	K12S-36	90000	6100	85	125	×	187	41	8000
HQI-TS 2000W/D/S HF K12S	4008321338310	OSRHQI-TS2000W/D/S	02	2000	K12S-36	230000	6200	83	200	×	187	41	4500
HQI-TS 2000W/D/S K12S	4050300271682	OSRHQI-TS2000D/S	03	2000	K12S-36	210000	6100	83	190	×	187	41	4500
HQI-TS 2000W/N/L K12S	4008321530660	OSRHQI-TS2000W/N/L	04	2000	K12S-36	230000	4100	65	200	×	274	40	8000
HQI-TS 2000W/NDL/S K12S 10X1	4008321525499	OSRHQI-TS2000W/NDL/S	05	2000	K12S-36	215000	4650	90	200	×	187	41	6000

ORDERING CODES - HIGH PRESSURE SODIUM LAMP



Product Name	EAN	Model Number	No.	W	mm	lm	K	Ra	V	h	mm	d (mm)	t (h)
VIALOX® NAV®-T													
NAV-T 150W E40	4050300015668	OSRNAV-T150	01	150	E40	15000	2000	25	100	✓ ¹	210	47	28000
NAV-T 250W E40	4050300015675	OSRNAV-T250	01	250	E40	28000	2000	25	100	✓ ¹	257	47	28000
NAV-T 400W E40	4050300015682	OSRNAV-T400	01	400	E40	48000	2000	25	100	✓ ¹	285	47	28000
VIALOX® NAV®-T SUPER 4Y® 50...400W													
NAV-T 50W SUPER 4Y E27	4052899415379	OSRNAV-T50S	02	50	E27	4200	2000	25	86	✓ ¹	155	36	28000
NAV-T 100W SUPER 4Y E40	4050300015743	OSRNAV-T100S	03	100	E40	10300	2000	25	100	✓ ¹	211	47	32000
NAV-T 250W SUPER 4Y E40	4050300024417	OSRNAV-T250S	03	250	E40	33200	2000	25	100	✓ ¹	257	47	32000
NAV-T 400W SUPER 4Y E40	40503000281179	OSRNAV-T400S	03	400	E40	56500	2000	25	100	✓ ¹	285	47	32000
NAV-T 600W SUPER 4Y E40	40503000275772	OSRNAV-T600S	03	600	E40	90000	2000	25	110	✓ ¹	285	47	32000
VIALOX® NAV®-TT													
NAV-T 150W S TT E40	4050300450827	OSRNAV-T150WSTT	04	150	E40	14500	2000	25	25	✗	210	47	35000
NAV-T 250W S TT E40	4050300427690	OSRNAV-T250W/TT	04	250	E40	25500	2000	25	25	✗	257	47	48000
NAV-T 400W S TT E40	4050300427713	OSRNAV-T400WSTT	04	400	E40	48000	2000	25	25	✗	285	47	48000

¹ Dimmable on conventional control gears and electronic control gears.

ORDERING CODES - HIGH PRESSURE SODIUM LAMP



01



02

Product Name	EAN	Model Number	No.	W	mm	lm	K	Ra	V	h	mm	d (mm)	t (h)
--------------	-----	--------------	-----	---	----	----	---	----	---	---	----	--------	-------

VIALOX® NAV®-E

NAV-E 70W/E E27	4050300015767	OSRNAV-E70/E	01	70	E27	5900	2000	25	90	✓	155	71	24000
NAV-E 100W SUPER 4Y E40	4050300015774	OSRNAV-E100S	02	100	E40	10100	2000	25	100	✓	180	76	32000
NAV-E 150W E40 EXTERNAL IGNITOR	4050300015613	OSRNAV-E150/E	02	150	E40	14500	2000	25	100	✓	226	91	28000
NAV-E 250W E40 EXTERNAL IGNITOR	4050300015620	OSRNAV-E250/E	02	250	E40	27000	2000	25	100	✓	226	91	28000
NAV-E 400W E40 EXTERNAL IGNITOR	4050300015637	OSRNAV-E400/E	02	400	E40	48000	2000	25	105	✓	290	122	28000

VIALOX® NAV®-E/I

NAV-E 50W/I E27 INTERNAL IGNITOR	4050300015583	OSRNAV-E50/I	01	50	E27	3700	2000	25	85	✗	155	71	24000
NAV-E 70W/I E27 INTERNAL IGNITOR	4050300015590	OSRNAV-E70/I	01	70	E27	5900	2000	25	90	✗	155	71	24000

ORDERING CODES - INCANDESCENT LAMP



Product Name	EAN	Model Number	No.	W	lm	K	Ra	V	h	d (mm)	t (mm)
--------------	-----	--------------	-----	---	----	---	----	---	---	--------	--------

SPECIAL OVEN T

SPC.T OVEN CL 15W 230V E14	4050300003108	OSROVENT26CL15WE14	01	15	E14	85	2700	100	230	✓	50	22	1000
SPC.T26/57 CL 15W 230V E14	4050300310282	OSRPILOT26CL15WE14	02	15	E14	85	2700	99	230	✓	55	26	1000
SPC.T26/57 FR 15W 230V E14	4050300003085	OSRPILOT26FR15WE14	02	15	E14	85	2700	99	230	✓	55	26	1000
SPC.T26/57 CL 25W 230V E14	4050300309637	OSRPILOT26CL25WE14	02	25	E14	140	2700	100	230	✓	55	26	1000

CONCENTRA® SPOT

CONC R63 SP 60W 230V E27 10X2 AU OSRAM	4099854145490	OSRCONC60WR63E27	03	60	E27	400	2350	100	220-240	✓	102	63	1000
CONC R80 100W 240V E27 10X2 AU OSRAM	4099854145513	OSRCONC100WR80E27	04	100	E27	500	2350	100	220-240	✓	110	80	1000
CONC R80 75W 240V E27 10X2 AU OSRAM	4099854145551	OSRCONC75WR80E27	04	75	E27	400	2350	100	220-240	✓	110	80	1000

ORDERING CODES - HALOGEN LAMP



Product Name	EAN	Model Number	No.	W	mm	lm	K	Ra	V	h	mm	d (mm)	t (h)
--------------	-----	--------------	-----	---	----	----	---	----	---	---	----	--------	-------

HALOGEN CLASSIC A

64543 A CLA 46W 240V B22D	4008321919083	OSR64543AES46WBC	01	46	B22D	700	2700	100	240	✓	93	55	2000
64543 A CLA 46W 240V E27	4008321229281	OSR64543ESA46WES	02	46	E27	700	2700	100	240	✓	94	55	2000
64543 A FR CLA 46W 240V B22D	4008321277244	OSR64543AESFRB22D46W	03	46	B22D	700	2700	100	240	✓	93	55	2000
64543 A FR CLA 46W 240V E27	4008321229380	OSR64543AESFRE2746W	04	46	E27	700	2700	100	240	✓	94	55	2000
64544 A CLA 57W 240V B22D	4008321403339	OSR64544AESCL53WBC	01	57	B22D	915	2800	100	240	✓	93	55	2000
64544 A CLA 57W 240V E27	4008321403315	OSR64544AESCL53WES	02	57	E27	915	2800	100	240	✓	94	55	2000
64544 A CLA FR 57W 240V B22D	4008321629531	OSR64544AESFR53WBC	03	57	B22D	915	2800	100	240	✓	93	55	2000
64544 A CLA FR 57W 240V E27	4008321466310	OSR64544AESFR53WES	04	57	E27	915	2800	100	240	✓	94	55	2000
64547 A CLA 77W 240V B22D	4008321936073	OSR64547AESCLBC70W	01	77	B22D	1320	2800	100	240	✓	93	55	2000
64547 A CLA 77W 240V E27	4008321936059	OSR64547AESCLE2777W	02	77	E27	1320	2800	100	240	✓	94	55	2000
64547 A CLA FR 77W 240V E27	4008321629555	OSR64547AECOFR	04	77	E27	1320	2800	100	240	✓	94	55	2000

ORDERING CODES - HALOGEN LAMP



Product Name	EAN	Model Number	No.	W	mm	lm	K	Ra	V	h	mm	d (mm)	t (h)
--------------	-----	--------------	-----	---	----	----	---	----	---	---	----	--------	-------

HALOGEN CLASSIC B

CLAS B CL 28W 240V E14 FS2 OSRAM	4099854040924	OSRCLASB28WE14	01	28	E14	360	2700	100	240	✓	98	35	2000
CLAS B FR 28W 240V E14 FS2 OSRAM	4099854040948	OSRCLASB28WE14FR	02	28	E14	360	2700	100	240	✓	98	35	2000
CLAS B CL 28W 240V B15 FS2 OSRAM	4099854040962	OSRCLASB28WB15	03	28	B15	360	2700	100	240	✓	98	35	2000
CLAS B FR 28W 240V B15 FS2 OSRAM	4099854040986	OSRCLASB28WB15FR	04	28	B15	360	2700	100	240	✓	98	35	2000
CLAS B CL 28W 240V E27 FS2 OSRAM	4099854041006	OSRCLASB28WE27	05	28	E27	360	2700	100	240	✓	94	35	2000
CLAS B CL 28W 240V B22D FS2 OSRAM	4099854041020	OSRCLASB28WE27FR	06	28	B22D	360	2700	100	240	✓	72	45	2000

HALOGEN CLASSIC P

CLAS P CL 28W 240V E27 FS2 OSRAM	4099854041044	OSRCLASP28WE27	07	28	E27	360	2700	100	240	✓	94	35	2000
CLAS P CL 28W 240V B22D FS2 OSRAM	4099854041068	OSRCLASP28WB22D	08	28	B22D	360	2700	100	240	✓	72	45	2000











ORDERING CODES - HALOGEN LAMP



Product Name	EAN	Model Number		W		lm	K	Ra	V				
HALOPIN® STANDARD													
66740 PRO 40W 240V G9	4008321826763	OSR66740CL	01	40	G9	490	2700	100	240	✓	43	14	2000
HALOPIN® SUPERSTAR													
66748 SST 50W 230V G9 10XBLL1 OSRAM	4008321945198	OSR66748SST	01	50	G9	740	2800	100	230	✓	43	14	2000
66748 SST 50W 230V G9 10XBLL2 OSRAM	4052899195394	OSR66748SST2	01	50	G9	740	2800	100	230	✓	43	14	2000
HALOSTAR® STANDARD													
64425 S 20W 12V G4	4008321150851	OSR64425S	02	20	G4	320	2800	100	12	✓	33	10	2000
64440 S 50W 12V GY6.35	4008321150936	OSR64440S	03	50	GY6.35	925	3000	100	12	✓	44	12	2000
DECOSTAR®													
46865 VWFL 35W 12V GU5.3 12X4 AU OSRAM	4099854145582	OSR46865	04	35	GU5.3	430	3000	100	12	✓	46	51	2000
44890 WFL 20W 12V GU4 FS1 OSRAM	4050300346168	OSR44890	05	20	GU4	205	2800	100	12	✓	40	35	4000
48860 PROWFL 20W 12V GU5.3 FS1 OSRAM	4050300620206	OSR48860	04	20	GU5.3	380	3000	100	12	✓	46	51	5000
HALOPAR® 38													
64839 FL 120W 220- 240V E27 10X1 AU OSRAM	4099854145612	OSR64839	06	120	E27	1150	2850	100	220- 240	✓	134	123	2000

ORDERING CODES - HALOGEN LAMP



Product Name	EAN	Model Number	 No.	 W	 E	 lm	 K	 Ra	 V		 L (mm)	 Ø (mm)	 t(h)
HALOSPOT® 111													
41835 SP 50W 12V G53 FS1 OSRAM	4050300011752	OSR41835	01	50	G5.3	510	2950	100	12	✓	67	111	4000
HALOLINE® STANDARD													
64760 1510W 240V R7S FS1 OSRAM	4050300209920	OSR64760	02	1510	R7S	30700	2900	100	240	✓	256	12	2000
64702 400W 240V R7S FS1 OSRAM	4008321275646	OSR64702	03	400	R7S	8750	2900	100	240	✓	120	12	2000
64690 80W 240V R7S FS1 OSRAM	4008321325396	OSR64690	04	80	R7S	1385	2900	100	240	✓	78	12	2000
64706 ST 500W 230V R7S FS1 OSRAM	4008321329479	OSR64706	03	500	R7S	7700	2900	100	230	✓	120	12	1000

ORDERING CODES - INFRARED LAMP



Product Name	EAN	Model Number	No.	W	mm	lm	K	Ra	V	°	mm	mm	t(h)
INFRA-RED													
IR PAR38 RED 150W 220-240V E26 12X1 ENLEDV	4058075774162	IR150WE26	01	150	E26	250 1200	-	220-240	✓	136	122	5000	
IR PAR38 CL 175W 220-240V E27 12X1 ENLEDV	4058075774124	IR175WE27CL	02	175	E27	900 2400	-	220-240	✓	136	122	5000	
IR PAR38 RED 175W 220-240V E27 12X1 ENLEDV	4058075774148	IR175WE27RED	03	175	E27	250 1200	-	220-240	✓	136	122	5000	





LED LAMP



LED LAMP WITH TRUWAVE TECHNOLOGY™

206



CLASSIC SHAPE LED LAMP

217



REFLECTOR LED LAMP

218



SPECIALIST LED LAMP

219



HQL LED & DULUX LED

220



NAV LED LAMP

221



LED TUBE

222

LED Lamp With TruWave Technology™

TruWave Technology™ LED lamps mimic the natural spectrum, of daylight. This cutting edge technology ensures the lamp has better colour rendering properties due to emitting a broader light spectrum. Research has shown that the TruWave light output has many advantages over traditional LED lamps, which have increased blue light spectrum than a TruWave Technology™ LED lamp.



FEATURES AND BENEFITS

- Support better sleep/wake cycle
Through mimicking the natural light spectrum, these lights can support the human circadian system and allow for a better sleep/wake cycle.
- Boosts attention and alertness
Through emitting a balanced blue light spectrum, these lights help with focus and attention during both daytime and night-time activities.
- Protects your eyes
By removing the intense and unnatural blue light peaks, these lights can reduce both glare and eye strain.
- Improves mood and life quality
Natural light can improve our sense of well-being and boost our mood, creating an uplifting environment no matter the weather.

AREAS OF APPLICATION

- Office
- School
- Retail shop
- Industry area
- Residential area
- Hospitality

TruWave
Technology™

ORDERING CODES - LED LAMP WITH TRUWAVE TECHNOLOGY™



Product Name	EAN	Model Number	No.	W	mm	lm	K	Ra	°	mm	mm	t(h)
--------------	-----	--------------	-----	---	----	----	---	----	---	----	----	------

TRI COLOUR CLASSIC A LAMP WITH TRUWAVE TECHNOLOGY™

LPCLA 8W 830/845/865 240V B22 10X1 AP LEDV	4099854082023	LDVCLA8WTRIB22	01	8	B22	800	3000/ 4000/ 6500	80	150	×	108	60	15000
LPCLA 8W 830/845/865 240V E27 10X1 AP LEDV	4099854081989	LDVCLA8WTRIE27	02	8	E27	800	3000/ 4000/ 6500	80	150	×	109	60	15000
LPCLAD 12W 830/845/865 240V B22 10X1 AP LEDV	4099854082047	LDVCLAD12WTRIB22	01	12	B22	1200	3000/ 4000/ 6500	80	150	✓	108	60	15000
LPCLAD 12W 830/845/865 240V E27 10X1 AP LEDV	4099854082009	LDVCLAD12WTRIE27	02	12	E27	1200	3000/ 4000/ 6500	80	150	✓	109	60	15000

TRI COLOUR STICK LAMP WITH TRUWAVE TECHNOLOGY™

LPSTICK 7W 830/845/865 240V B15 10X1 AP LEDV	4099854082146	LDVSTK7WTRIB15	03	7	B15	700	3000/ 4000/ 6500	80	170	×	109	40	15000
LPSTICK 7W 830/845/865 240V E14 10X1 AP LEDV	4099854082085	LDVSTK7WTRIE14	04	7	E14	700	3000/ 4000/ 6500	80	170	×	110	40	15000
LPSTICK 9W 830/845/865 240V B22 10X1 AP LEDV	4099854082160	LDVSTK9WTRIB22	05	9	B22	900	3000/ 4000/ 6500	80	170	×	106	40	15000
LPSTICK 9W 830/845/865 240V E27 10X1 AP LEDV	4099854082108	LDVSTK9WTRIE27	06	9	E27	900	3000/ 4000/ 6500	80	170	×	107	40	15000
LPSTICKD 9W 830/845/865 240V B22 10X1 AP LEDV	4099854082184	LDVSTKD9WTRIB22	05	9	B22	900	3000/ 4000/ 6500	80	170	✓	106	40	15000
LPSTICKD 9W 830/845/865 240V E27 10X1 AP LEDV	4099854082122	LDVSTKD9WTRIE27	06	9	E27	900	3000/ 4000/ 6500	80	170	✓	107	40	15000

ORDERING CODES - LED LAMP WITH TRUWAVE TECHNOLOGY™



Product Name	EAN	Model Number	No.	W	lm	K	Ra	°	mm	mm	t(h)
--------------	-----	--------------	-----	---	----	---	----	---	----	----	------

TRI COLOUR MR16 WITH TRUWAVE TECHNOLOGY™

LPMR163538 4W 830/845/865 12V 10X1 AP LEDV	4099854082245	LDVMR164WTRIGU5.3	01	4	GU5.3	320	3000/ 4000/ 6500	80	38	×	55	50	15000
LPMR165038 6W 830/845/865 12V 10X1 AP LEDV	4099854082269	LDVMR166WTRIGU5.3	01	6	GU5.3	480	3000/ 4000/ 6500	80	38	×	55	50	15000

TRI COLOUR PAR16 WITH TRUWAVE TECHNOLOGY™

LPPAR163550 4W 830/845/865 240V 10X1 AP LEDV	4099854082207	LDVPAR164WTRIGU10	02	4	GU10	320	3000/ 4000/ 6500	80	50	×	60	50	15000
LPPAR163550 6W 830/845/865 240V 10X1 AP LEDV	4099854082221	LDVPAR166WTRIGU10	02	6	GU10	480	3000/ 4000/ 6500	80	50	×	60	50	15000

TRI COLOUR T8 TUBE WITH TRUWAVE TECHNOLOGY™

LPT8-0.6M 8W 830/845/865 240V FS1 LEDV	4099854088322	LDVT80.6M8WTRI	03	8	G13	800	3000/ 4000/ 6500	80	200	×	600	28	25000
LPT8-1.2M 16W 830/845/865 240V FS1 LEDV	4099854088346	LDVT81.2M16WTRI	03	16	G13	1600	3000/ 4000/ 6500	80	200	×	1200	28	25000
LPT8-1.5M 20W 830/845/865 240V FS1 LEDV	4099854088360	LDVT81.5M20WTRI	03	20	G13	2000	3000/ 4000/ 6500	80	200	×	1500	28	25000

ORDERING CODES - LED LAMP WITH TRUWAVE TECHNOLOGY™



Product Name	EAN	Model Number	No.	W	mm	lm	K	Ra	°	mm	mm	t(h)
--------------	-----	--------------	-----	---	----	----	---	----	---	----	----	------

LED CLASSIC A LAMP WITH TRUWAVE TECHNOLOGY™

LVCLA75 10W/827 230V FR B22D 10X1 G7T AULEDV	4058075732315	LDVCLA10W827B22FR	01	10	B22D	1055	2700	80	200	×	118	60	15000
LVCLA75 10W/827 230V FR E27 10X1 G7T AULEDV	4058075732339	LDVCLA10W827E27FR	02	10	E27	1055	2700	80	200	×	118	60	15000
LVCLA75 10W/865 230V FR B22D 10X1 G7T AULEDV	4058075732353	LDVCLA10W865B22FR	01	10	B22D	1055	6500	80	200	×	117	60	15000
LVCLA75 10W/865 230V FR E27 10X1 G7T AULEDV	4058075732377	LDVCLA10W865E27FR	02	10	E27	1055	6500	80	200	×	117	60	15000
LVCLA100 13W/827 230V FR B22D 10X1 G7T AULEDV	4058075732254	LDVCLA13W827B22FR	01	13	B22D	1521	2700	80	200	×	118	60	15000
LVCLA100 13W/827 230V FR E27 10X1 G7T AULEDV	4058075732230	LDVCLA13W827E27FR	02	13	E27	1521	2700	80	200	×	118	60	15000
LVCLA100 13W/865 230V FR B22D 10X1 G7T AULEDV	4058075732292	LDVCLA13W865B22FR	01	13	B22D	1521	6500	80	200	×	117	60	15000
LVCLA100 13W/865 230V FR E27 10X1 G7T AULEDV	4058075732278	LDVCLA13W865E27FR	02	13	E27	1521	6500	80	200	×	117	60	15000

ORDERING CODES - LED LAMP WITH TRUWAVE TECHNOLOGY™



Product Name	EAN	Model Number	No.	W	Im	K	Ra	°	↓ (mm)	∅ d (mm)	t(h)
--------------	-----	--------------	-----	---	----	---	----	---	--------	----------	------

LED STICK LAMP WITH TRUWAVE TECHNOLOGY™

LP STICK DIM7W/827 230V B22D 10X1G2TAULEDV	4058075731998	LDVSTK7W827B22	01	7	B22D	700	2700	80	200	✓	113	40	25000
LP STICK DIM 7W/827 230V E27 10X1G2TAULEDV	4058075731974	LDVSTK7W827E27	02	7	E27	700	2700	80	200	✓	114	40	25000
LP STICK DIM7W/840 230V B22D 10X1G2TAULEDV	4058075732032	LDVSTK7W840B22	01	7	B22D	750	4000	80	200	✓	113	40	25000
LP STICK DIM 7W/840 230V E27 10X1G2TAULEDV	4058075732018	LDVSTK7W840E27	02	7	E27	750	4000	80	200	✓	114	40	25000
LP STICK DIM7W/865 230V B22D 10X1G2TAULEDV	4058075732070	LDVSTK7W865B22	01	7	B22D	750	6500	80	200	✓	113	40	25000
LP STICK DIM 7W/865 230V E27 10X1G2TAULEDV	4058075732056	LDVSTK7W865E27	02	7	E27	750	6500	80	200	✓	114	40	25000
LP STICK DIM9W/827 230V B22D 10X1G3TAULEDV	4058075732094	LDVSTK9W827B22	01	9	B22D	750	2700	80	200	✓	114	41	15000
LP STICK DIM 9W/827 230V E27 10X1G3TAULEDV	4058075733695	LDVSTK9W827E27	02	9	E27	750	2700	80	200	✓	114	41	15000
LP STICK DIM9W/840 230V B22D 10X1G3TAULEDV	4058075732117	LDVSTK9W840B22	01	9	B22D	800	4000	80	200	✓	114	41	15000
LP STICK DIM 9W/840 230V E27 10X1G3TAULEDV	4058075733718	LDVSTK9W840E27	02	9	E27	800	4000	80	200	✓	114	41	15000
LP STICK DIM9W/865 230V B22D 10X1G3TAULEDV	4058075732155	LDVSTK9W865B22	01	9	B22D	800	6500	80	200	✓	114	41	15000
LP STICK DIM 9W/865 230V E27 10X1G3TAULEDV	4058075732131	LDVSTK9W865E27	02	9	E27	800	6500	80	200	✓	114	41	15000
LP STICKDIM11W/827 230V B22D 10X1G3TAULEDV	4058075732179	LDVSTK11W827B22	03	11	B22D	1000	2700	80	200	✓	121	46	15000
LP STICK DIM11W/827 230V E27 10X1G3TAULEDV	4058075731912	LDVSTK11W827E27	04	11	E27	1000	2700	80	200	✓	121	46	15000
LP STICKDIM11W/840 230V B22D 10X1G3TAULEDV	4058075732193	LDVSTK11W840B22	03	11	B22D	1050	4000	80	200	✓	121	46	15000
LP STICK DIM11W/840 230V E27 10X1G3TAULEDV	4058075731936	LDVSTK11W840E27	04	11	E27	1050	4000	80	200	✓	121	46	15000
LP STICKDIM11W/865 230V B22 D10X1G3TAULEDV	4058075732216	LDVSTK11W865B22	03	11	B22D	1050	6500	80	200	✓	121	46	15000
LP STICK DIM11W/865 230V E27 10X1G3TAULEDV	4058075731950	LDVSTK11W865E27	04	11	E27	1050	6500	80	200	✓	121	46	15000

ORDERING CODES - LED LAMP WITH TRUWAVE TECHNOLOGY™



Product Name	EAN	Model Number	No.	W	lm	K	Ra	°	mm	mm	th
--------------	-----	--------------	-----	---	----	---	----	---	----	----	----

LED FILAMENT LAMP WITH TRUWAVE TECHNOLOGY™

CLEAR

LPCLADIM 7W/827 230V FILE2710X1G4APLEDV	4058075745476	LDVFIL7W827E27	01	7	E27	806	2700	80	300	✓	106	60	15000
LPCLADIM 7W/827 230V FILB22D10X1G4APLEDV	4058075745575	LDVFIL7W827B22	02	7	B22D	806	2700	80	300	✓	104	60	15000
LPCLADIM 7W/840 230V FILE2710X1G4APLEDV	4058075745674	LDVFIL7W840E27	01	7	E27	806	4000	80	300	✓	106	60	15000
LPCLADIM 7W/840 230V FILB22D10X1G4APLEDV	4058075745797	LDVFIL7W840B22	02	7	B22D	806	4000	80	300	✓	104	60	15000
LPCLADIM 7W/865 230V FILE2710X1G4APLEDV	4058075745872	LDVFIL7W865E27	01	7	E27	806	6500	80	300	✓	106	60	15000
LPCLADIM 7W/865 230V FILB22D10X1G4APLEDV	4058075745957	LDVFIL7W865B22	02	7	B22D	806	6500	80	300	✓	104	60	15000

FROSTED

LPCLADIM 7W/827 230V GLFRE2710X1G4APLEDV	4058075746015	LDVFIL7W827E27FR	01	7	E27	806	2700	80	300	✓	106	60	15000
LPCLADIM 7W/827 230V GLFRB22D10X1G4APLEDV	4058075746107	LDVFIL7W827B22FR	02	7	B22D	806	2700	80	300	✓	104	60	15000
LPCLADIM 7W/840 230V GLFRE2710X1G4APLEDV	4058075746183	LDVFIL7W840E27FR	01	7	E27	806	4000	80	300	✓	106	60	15000
LPCLADIM 7W/840 230V GLFRB22D10X1G4APLEDV	4058075746251	LDVFIL7W840B22FR	02	7	B22D	806	4000	80	300	✓	104	60	15000
LPCLADIM 7W/865 230V GLFRE2710X1G4APLEDV	4058075746503	LDVFIL7W865E27FR	01	7	E27	806	6500	80	300	✓	106	60	15000
LPCLADIM 7W/865 230V GLFRB22D10X1G4APLEDV	4058075746527	LDVFIL7W865B22FR	02	7	B22D	806	6500	80	300	✓	104	60	15000

LED LAMP WITH TRUWAVE TECHNOLOGY™

ORDERING CODES - LED LAMP WITH TRUWAVE TECHNOLOGY™



Product Name	EAN	Model Number	No.	W	lm	K	Ra	°	h	d	th
--------------	-----	--------------	-----	---	----	---	----	---	---	---	----

LED FILAMENT LAMP WITH TRUWAVE TECHNOLOGY™

CLEAR

LPCLBDIM 4W/827 230V FILE1410X1G4APLEDV	4058075745087	LDVCLB4W827E14	01	4	E14	470	2700	80	300	✓	98	35	15000
LPCLBDIM 4W/827 230V FILE2710X1G4APLEDV	4058075745100	LDVCLB4W827E27	02	4	E27	470	2700	80	300	✓	92	35	15000
LPCLBDIM 4W/827 230V FILB15D10X1G4APLEDV	4058075745148	LDVCLB4W827B15	03	4	B15D	470	2700	80	300	✓	96	35	15000
LPCLBDIM 4W/827 230V FILB22D10X1G4APLEDV	4058075745292	LDVCLB4W827B22	04	4	B22D	470	2700	80	300	✓	90	35	15000
LPCLBDIM 4W/840 230V FILE1410X1G4APLEDV	4058075745339	LDVCLB4W840E14	01	4	E14	470	4000	80	300	✓	98	35	15000
LPCLBDIM 4W/840 230V FILE2710X1G4APLEDV	4058075745377	LDVCLB4W840E27	02	4	E27	470	4000	80	300	✓	92	35	15000
LPCLBDIM 4W/840 230V FILB15D10X1G4APLEDV	4058075745414	LDVCLB4W840B15	03	4	B15D	470	4000	80	300	✓	96	35	15000
LPCLBDIM 4W/840 230V FILB22D10X1G4APLEDV	4058075745490	LDVCLB4W840B22	04	4	B22D	470	4000	80	300	✓	90	35	15000
LPCLBDIM 4W/865 230V FILE1410X1G4APLEDV	4058075745537	LDVCLB4W865E14	01	4	E14	470	6500	80	300	✓	98	35	15000
LPCLBDIM 4W/865 230V FILE2710X1G4APLEDV	4058075745551	LDVCLB4W865E27	02	4	E27	470	6500	80	300	✓	92	35	15000
LPCLBDIM 4W/865 230V FILB15D10X1G4APLEDV	4058075745599	LDVCLB4W865B15	03	4	B15D	470	6500	80	300	✓	96	35	15000
LPCLBDIM 4W/865 230V FILB22D10X1G4APLEDV	4058075745636	LDVCLB4W865B22	04	4	B22D	470	6500	80	300	✓	90	35	15000

ORDERING CODES - LED LAMP WITH TRUWAVE TECHNOLOGY™



Product Name	EAN	Model Number	No.	W	lm	K	Ra	°	mm	mm	th
--------------	-----	--------------	-----	---	----	---	----	---	----	----	----

LED FILAMENT LAMP WITH TRUWAVE TECHNOLOGY™

FROSTED

LPCLBDIM 4W/827 230V GLFRE1410X1G4APLEDV	4058075745735	LDVCLB4W827E14FR	01	4	E14	470	2700	80	300	✓	98	35	15000
LPCLBDIM 4W/827 230V GLFRE2710X1G4APLEDV	4058075745773	LDVCLB4W827E27FR	02	4	E27	470	2700	80	300	✓	92	35	15000
LPCLBDIM 4W/827 230V GLFRB15D10X1G4APLEDV	4058075745834	LDVCLB4W827B15FR	03	4	B15D	470	2700	80	300	✓	96	35	15000
LPCLBDIM 4W/827 230V GLFRB22D10X1G4APLEDV	4058075745896	LDVCLB4W827B22FR	04	4	B22D	470	2700	80	300	✓	90	35	15000
LPCLBDIM 4W/840 230V GLFRE1410X1G4APLEDV	4058075745933	LDVCLB4W840E14FR	01	4	E14	470	4000	80	300	✓	98	35	15000
LPCLBDIM 4W/840 230V GLFRE2710X1G4APLEDV	4058075745995	LDVCLB4W840E27FR	02	4	E27	470	4000	80	300	✓	92	35	15000
LPCLBDIM 4W/840 230V GLFRB15D10X1G4APLEDV	4058075746053	LDVCLB4W840B15FR	03	4	B15D	470	4000	80	300	✓	96	35	15000
LPCLBDIM 4W/840 230V GLFRB22D10X1G4APLEDV	4058075746084	LDVCLB4W840B22FR	04	4	B22D	470	4000	80	300	✓	90	35	15000
LPCLBDIM 4W/865 230V GLFRE1410X1G4APLEDV	4058075746145	LDVCLB4W865E14FR	01	4	E14	470	6500	80	300	✓	98	35	15000
LPCLBDIM 4W/865 230V GLFRE2710X1G4APLEDV	4058075746206	LDVCLB4W865E27FR	02	4	E27	470	6500	80	300	✓	92	35	15000
LPCLBDIM 4W/865 230V GLFRB15D10X1G4APLEDV	4058075746237	LDVCLB4W865B15FR	03	4	B15D	470	6500	80	300	✓	96	35	15000
LPCLBDIM 4W/865 230V GLFRB22D10X1G4APLEDV	4058075746275	LDVCLB4W865B22FR	04	4	B22D	470	6500	80	300	✓	90	35	15000

ORDERING CODES - LED LAMP WITH TRUWAVE TECHNOLOGY™



Product Name	EAN	Model Number	No.	W	lm	K	Ra	°	mm	mm	t(h)
--------------	-----	--------------	-----	---	----	---	----	---	----	----	------

LED FILAMENT LAMP WITH TRUWAVE TECHNOLOGY™

CLEAR

LPCLPDIM 4W/827 230V FILE1410X1G4APLEDV	4058075745254	LDVCLP4W827E14	01	4	E14	470	2700	80	300	✓	78	45	15000
LPCLPDIM 4W/827 230V FILE2710X1G4APLEDV	4058075745353	LDVCLP4W827E27	02	4	E27	470	2700	80	300	✓	74	45	15000
LPCLPDIM 4W/827 230V FILB15D10X1G4APLEDV	4058075745391	LDVCLP4W827B15	03	4	B15D	470	2700	80	300	✓	76	45	15000
LPCLPDIM 4W/827 230V FILB22D10X1G4APLEDV	4058075745438	LDVCLP4W827B22	04	4	B22D	470	2700	80	300	✓	72	45	15000
LPCLPDIM 4W/840 230V FILE1410X1G4APLEDV	4058075745452	LDVCLP4W840E14	01	4	E14	470	4000	80	300	✓	78	45	15000
LPCLPDIM 4W/840 230V FILE2710X1G4APLEDV	4058075745513	LDVCLP4W840E27	02	4	E27	470	4000	80	300	✓	74	45	15000
LPCLPDIM 4W/840 230V FILB15D10X1G4APLEDV	4058075745612	LDVCLP4W840B15	03	4	B15D	470	4000	80	300	✓	76	45	15000
LPCLPDIM 4W/840 230V FILB22D10X1G4APLEDV	4058075745650	LDVCLP4W840B22	04	4	B22D	470	4000	80	300	✓	72	45	15000
LPCLPDIM 4W/865 230V FILE1410X1G4APLEDV	4058075745698	LDVCLP4W865E14	01	4	E14	470	6500	80	300	✓	78	45	15000
LPCLPDIM 4W/865 230V FILE2710X1G4APLEDV	4058075745711	LDVCLP4W865E27	02	4	E27	470	6500	80	300	✓	74	45	15000
LPCLPDIM 4W/865 230V FILB15D10X1G4APLEDV	4058075745759	LDVCLP4W865B15	03	4	B15D	470	6500	80	300	✓	76	45	15000
LPCLPDIM 4W/865 230V FILB22D10X1G4APLEDV	4058075745810	LDVCLP4W865B22	04	4	B22D	470	6500	80	300	✓	72	45	15000

ORDERING CODES - LED LAMP WITH TRUWAVE TECHNOLOGY™



Product Name	EAN	Model Number	No.	W	lm	K	Ra	°	h	mm	Ø (mm)	t (h)
--------------	-----	--------------	-----	---	----	---	----	---	---	----	--------	-------

LED FILAMENT LAMP WITH TRUWAVE TECHNOLOGY™

FROSTED

LPCLPDIM 4W/827 230V GLFRE1410X1G4APLEDV	4058075745858	LDVCLP4W827E14FR	01	4	E14	470	2700	80	300	✓	78	45	15000
LPCLPDIM 4W/827 230V GLFRE2710X1G4APLEDV	4058075746299	LDVCLP4W827E27FR	02	4	E27	470	2700	80	300	✓	85	45	15000
LPCLPDIM 4W/827230V GLFRB15D10X1G4APLEDV	4058075745919	LDVCLP4W827B15FR	03	4	B15D	470	2700	80	300	✓	76	45	15000
LPCLPDIM 4W/827 230V GLFRB22D10X1G4APLEDV	4058075746312	LDVCLP4W827B22FR	04	4	B22D	470	2700	80	300	✓	83	45	15000
LPCLPDIM 4W/840 230V GLFRE1410X1G4APLEDV	4058075745971	LDVCLP4W840E14FR	01	4	E14	470	4000	80	300	✓	78	45	15000
LPCLPDIM 4W/840 230V GLFRE2710X1G4APLEDV	4058075746336	LDVCLP4W840E27FR	02	4	E27	470	4000	80	300	✓	85	45	15000
LPCLPDIM 4W/840230V GLFRB15D10X1G4APLEDV	4058075746039	LDVCLP4W840B15FR	03	4	B15D	470	4000	80	300	✓	76	45	15000
LPCLPDIM 4W/840 230V GLFRB22D10X1G4APLEDV	4058075746350	LDVCLP4W840B22FR	04	4	B22D	470	4000	80	300	✓	83	45	15000
LPCLPDIM 4W/865 230V GLFRE1410X1G4APLEDV	4058075746121	LDVCLP4W865E14FR	01	4	E14	470	6500	80	300	✓	78	45	15000
LPCLPDIM 4W/865 230V GLFRE2710X1G4APLEDV	4058075746374	LDVCLP4W865E27FR	02	4	E27	470	6500	80	300	✓	85	45	15000
LPCLPDIM 4W/865230V GLFRB15D10X1G4APLEDV	4058075746169	LDVCLP4W865B15FR	03	4	B15D	470	6500	80	300	✓	76	45	15000
LPCLPDIM 4W/865 230V GLFRB22D10X1G4APLEDV	4058075746398	LDVCLP4W865B22FR	04	4	B22D	470	6500	80	300	✓	83	45	15000

ORDERING CODES - LED LAMP WITH TRUWAVE TECHNOLOGY™



Product Name	EAN	Model Number	Light No.	W	Beam	lm	K	Ra	Temp	Life	Ø d (mm)	t(h)
--------------	-----	--------------	-----------	---	------	----	---	----	------	------	----------	------

LED MR16 36D WITH TRUWAVE TECHNOLOGY™

LPMR165036 8W/927 12V GU5.3 10X1TAULEDV	4058075731301	LDVMR168W927GU5.3	01	8	GU5.3	670	2700	90	36	✓	44	50	25000
LPMR165036 8W/940 12V GU5.3 10X1TAULEDV	4058075731325	LDVMR168W940GU5.3	01	8	GU5.3	670	4000	90	36	✓	44	50	25000
LPMR165036 8W/965 12V GU5.3 10X1TAULEDV	4058075731349	LDVMR168W965GU5.3	01	8	GU5.3	670	6500	90	36	✓	44	50	15000

LED MR16 60D WITH TRUWAVE TECHNOLOGY™

LPMR1650607,5W/930 12V GU5.3 10X1 AR7 AU LEDV	4099854042195	LDVMR167.5W830GU5.3	02	7.5	GU5.3	760	3000	90	60	✓	46	50	25000
LPMR1650607,5W/940 12V GU5.3 10X1 AR7 AU LEDV	4099854042218	LDVMR167.5W840GU5.3	02	7.5	GU5.3	760	4000	90	60	✓	46	50	25000
LPMR1650607,5W/965 12V GU5.3 10X1 AR7 AU LEDV	4099854042232	LDVMR167.5W865GU5.3	02	7.5	GU5.3	760	6500	90	60	✓	46	50	25000

LED PAR16 60D WITH TRUWAVE TECHNOLOGY™

LPPR1650605,5W/930 230 GU10 10X1AR7TAULEDV	4058075737891	LDVPAR165.5W930GU10	03	5.5	GU10	350	3000	90	60	✓	55	51	25000
LPPR1650605,5W/940 230 GU10 10X1AR7TAULEDV	4058075737914	LDVPAR165.5W940GU10	03	5.5	GU10	350	4000	90	60	✓	55	51	25000
LPPR1650605,5W/965 230 GU10 10X1AR7TAULEDV	4058075737938	LDVPAR165.5W965GU10	03	5.5	GU10	350	6500	90	60	✓	55	51	25000

LED T8 TUBE WITH TRUWAVE TECHNOLOGY™

LVT8V-0.6M 8W/830 230V EM25X1G10TAULEDV	4058075733459	LDVT80.6M8W830	04	8	G13	850	3000	80	160	✗	604	28	30000
LVT8V-0.6M 8W/840 230V EM25X1G10TAULEDV	4058075733473	LDVT80.6M8W840	04	8	G13	900	4000	80	160	✗	604	28	30000
LVT8V-0.6M 8W/865 230V EM25X1G10TAULEDV	4058075733497	LDVT80.6M8W865	04	8	G13	900	6500	80	160	✗	604	28	30000
LVT8V-1.2M 16W/830 230V EM25X1G10TAULEDV	4058075733510	LDVT81.2M16W830	04	16	G13	1700	3000	80	160	✗	1213	28	30000
LVT8V-1.2M 16W/840 230V EM25X1G10TAULEDV	4058075733534	LDVT81.2M16W840	04	16	G13	1800	4000	80	160	✗	1213	28	30000
LVT8V-1.2M 16W/865 230V EM25X1G10TAULEDV	4058075733558	LDVT81.2M16W865	04	16	G13	1800	6500	80	160	✗	1213	28	30000
LVT8V-1.5M 20W/830 230V EM25X1G10TAULEDV	4058075733572	LDVT81.5M20W830	04	20	G13	2200	3000	80	160	✗	1514	28	30000
LVT8V-1.5M 20W/840 230V EM25X1G10TAULEDV	4058075733596	LDVT81.5M20W840	04	20	G13	2400	4000	80	160	✗	1514	28	30000
LVT8V-1.5M 20W/865 230V EM25X1G10TAULEDV	4058075733619	LDVT81.5M20W865	04	20	G13	2400	6500	80	160	✗	1514	28	30000

ORDERING CODES - CLASSIC SHAPE LED LAMP



Product Name	EAN	Model Number	No.	W	Im	K	Ra	°	h	mm	g	th
--------------	-----	--------------	-----	---	----	---	----	---	---	----	---	----

LED VALUE CLASSIC A60

LV CLA60 8.5W/827 230V FR E27 G5	4058075282803	OSRLVCLA608.5W827E27G5	01	8.5	E27	806	2700	80	180	×	113	60	15000
LV CLA60 8.5W/865 230V FR E27 G5	4058075282827	OSRLVCLA608.5W865E27G5	01	8.5	E27	806	6500	80	180	×	113	60	15000
LV CLA60 8.5W/827 230V FR B22D G5	4058075282841	OSRLVCLA608.5W827B22G5	02	8.5	B22D	806	2700	80	180	×	113	60	15000
LV CLA60 8.5W/865 230V FR B22D G5	4058075282865	OSRLVCLA608.5W865B22G5	02	8.5	B22D	806	6500	80	180	×	113	60	15000

LED VALUE CLASSIC A75

LV CLA75 10W/827 230V FR E27 G5	4058075412712	OSRLVCLA7510W827E27G5	03	10	E27	1055	2700	80	180	×	118	60	10000
LV CLA75 10W/865 230V FR E27 G5	4058075412774	OSRLVCLA7510W865E27G5	03	10	E27	1055	6500	80	180	×	118	60	15000
LV CLA75 10W/827 230V FR B22D G5	4058075412699	OSRLVCLA7510W827B22G5	04	10	B22D	1055	2700	80	180	×	117	60	15000
LV CLA75 10W/865 230V FR B22D G5	4058075412736	OSRLVCLA7510W865B22G5	04	10	B22D	1055	6500	80	180	×	117	60	15000

LED VALUE CLASSIC A100

LV CLA100 13W/827 230V FR E27 G5	4058075412651	OSRLVCLA10013W827E27G5	03	13	E27	1521	2700	80	180	×	118	60	15000
LV CLA100 13W/865 230V FR E27 G5	4058075412675	OSRLVCLA10013W865E27G5	03	13	E27	1521	6500	80	180	×	118	60	15000
LV CLA100 13W/827 230V FR B22D G5	4058075412538	OSRLVCLA10013W827B22G5	04	13	B22D	1521	2700	80	180	×	117	60	15000
LV CLA100 13W/865 230V FR B22D G5	4058075412637	OSRLVCLA10013W865B22G5	04	13	B22D	1521	6500	80	180	×	117	60	15000

LED PERFORMANCE CLASSIC A DIMMABLE

LPCLA DIM 9W/827 230V FR E27 G2	4058075215313	OSRCLA9W827E27DIM	05	9	E27	806	2700	80	240	✓	108	61	25000
LPCLA DIM 9W/865 230V FR E27 G2	4058075215337	OSRCLA9W865E27DIM	05	9	E27	806	6500	80	240	✓	108	61	25000

ORDERING CODES - REFLECTOR LED LAMP



Product Name	EAN	Model Number	No.	W	lm	K	Ra	°	L (mm)	∅ d (mm)	t(h)
--------------	-----	--------------	-----	---	----	---	----	---	--------	----------	------

LED MR11 9W 36DEG

LEDS MR11 2036 2,9W/827 12V GU4	4058075433403	OSRLEDMR112.9W827GU4	01	2.5	GU4	184	2700	80	36	×	38	35	15000
------------------------------------	----------------------	----------------------	-----------	-----	-----	-----	------	----	----	---	----	----	-------

LED PERFORMANCE PAR16 HIGH BRIGHTNESS

LPPAR1611036 10W/930 230V HB GU10 10X1 G2	4058075415850	OSRLEDGU1010W93036D	02	10	GU10	830	3000	95	36	✓	77	49	40000
---	----------------------	---------------------	-----------	----	------	-----	------	----	----	---	----	----	-------

LPPAR1611036 10W/940 230V HB GU10 10X1 G2	4058075415881	OSRLEDGU1010W94036D	02	10	GU10	900	4000	95	36	✓	77	49	40000
---	----------------------	---------------------	-----------	----	------	-----	------	----	----	---	----	----	-------

LED PAR20

LPPAR20D5036 5W/827 230V E27	4058075184497	OSRLEDPAR205W827E27D	03	5	E27	400	2700	80	20	✓	88	64	25000
---------------------------------	----------------------	----------------------	-----------	---	-----	-----	------	----	----	---	----	----	-------

LED STAR PAR30 230V

LEDS PAR30 115 11W/827 230V 30D E27	4058075050891	OSRLEDPAR3011W827E27	04	11	E27	1000	2700	80	30	×	93	95	25000
---	----------------------	----------------------	-----------	----	-----	------	------	----	----	---	----	----	-------

PARATHOM® DIM PAR30

LPPAR30D 75 36 10,5W/827 230V E27	4058075184510	OSRLEDPAR3010.5W827E27D	05	10.5	E27	750	2700	80	30	✓	90	95	25000
--------------------------------------	----------------------	-------------------------	-----------	------	-----	-----	------	----	----	---	----	----	-------

PARATHOM® PAR38

LPPAR3812030 12W/827 230V E27	4058075264106	OSRLEDPAR3812W827E27	06	12	E27	1035	2700	80	30	×	134	122	25000
----------------------------------	----------------------	----------------------	-----------	----	-----	------	------	----	----	---	-----	-----	-------

LPPAR3812030 12W/865 230V E27	4058075665934	OSRLEDPAR3812W865E27	06	12	E27	1035	6500	80	30	×	134	122	25000
----------------------------------	----------------------	----------------------	-----------	----	-----	------	------	----	----	---	-----	-----	-------

ORDERING CODES - SPECIALIST LED LAMP



Product Name	EAN	Model Number	No.	W	mm	lm	K	Ra	°	mm	mm	t(h)
--------------	-----	--------------	-----	---	----	----	---	----	---	----	----	------

VINTAGE 1906 LED DIM

1906 ED 7.5W/825 230V FIL GD E27 G2	4058075496545	OSRLEDVINTED7.5WE27GD	01	7.5	E27	725	2500	80	320	✓	145	64	15000
--	----------------------	-----------------------	-----------	-----	-----	-----	------	----	-----	---	-----	----	-------

LED SPECIAL PILOT T26

LEDT2620 2,3W/865 230VFR E14 10X1	4058075509580	OSRLEDPILOT865E1410X1G2	02	2.3	E14	200	6500	80	160	✗	63	25	15000
--------------------------------------	----------------------	-------------------------	-----------	-----	-----	-----	------	----	-----	---	----	----	-------

LED STAR PIN G4, G9

LEDPPIN30 CL 2,6W/827 12V G4 20X1	4058075432048	OSRLEDG42.6W82712V	03	2.6	G4	300	2700	80	360	✗	40	14,0	15000
---	----------------------	--------------------	-----------	-----	----	-----	------	----	-----	---	----	------	-------

LEDSPIN30 CL 2,6W/827 230V G9 9XBLI1	4058075812055	OSRLEDG92.6W827	04	2.6	G9	320	2700	80	360	✗	52	15,0	15000
--	----------------------	-----------------	-----------	-----	----	-----	------	----	-----	---	----	------	-------

LEDSPIN32D CL 3,5W/827 230V G9 9XBLI1	4058075811935	OSRLEDG93.5W827D	05	3.5	G9	350	2700	80	360	✓	58	20,0	25000
---	----------------------	------------------	-----------	-----	----	-----	------	----	-----	---	----	------	-------

LED LINE R7S DIM

LEDLI7875 9,5W/827 230V R7S 10X1G2	4058075711105	OSRLED9.5W827R7S78	06	9.5	R7S	1055	2700	80	300	✓	78	28	25000
---------------------------------------	----------------------	--------------------	-----------	-----	-----	------	------	----	-----	---	----	----	-------

LEDCLI 118 100 12,5W/827 230V R7S 9XBLI1	4058075552159	OSRLED12.5W827R7S118	07	12.5	R7S	1521	2700	80	300	✗	118	29	15000
--	----------------------	----------------------	-----------	------	-----	------	------	----	-----	---	-----	----	-------

LEDCLI 118 125 15W/827 230V R7S 9XBLI1	4058075552173	OSRLEDCLI11812515	07	15	R7S	2000	2700	80	300	✗	118	29	15000
--	----------------------	-------------------	-----------	----	-----	------	------	----	-----	---	-----	----	-------

ORDERING CODES - HQL LED & DULUX LED



Product Name	EAN	Model Number	No.	W	mm	lm	K	Ra	°	mm	mm	mm	t(h)
--------------	-----	--------------	-----	---	----	----	---	----	---	----	----	----	------

HQL LED PRO

HQLLED2000 16W/840 230V PRO E27 G3	4058075411418	OSRHQLLED16W840E27G3	01	16	E27	2000	4000	80	360	×	153	75	50000
HQLLED3000 23W/840 230V PRO E27 G3	4058075411432	OSRHQLLED23W840E27G3	02	23	E27	3000	4000	80	360	×	145	75	50000
HQLLED4000 30W/840 230V PRO E27 G3	4058075411456	OSRHQLLED30W840E27G3	03	30	E27	4000	4000	80	360	×	170	75	50000
HQLLED6000 46W/840 230V PRO E27 G3	4058075411470	OSRHQLLED46W840E27G3	04	46	E27	6000	4000	80	360	×	195	80	50000
HQLLED6000 46W/840 230V PRO E40 G3	4058075411494	OSRHQLLED46W840E40G3	05	46	E40	6000	4000	80	360	×	204	80	50000

DULUX LED D EM & AC MAINS

DULUX D LED 7W/840 230V EM G24D-2	4058075024939	OSRLEDDULUXD7W8402P	06	7	G24D-2	700	4000	80	360	×	148	35	30000
DULUX D LED 10W/840 230V EM G24D-3	4058075024991	OSRLEDDULUXD10W8402P	07	10	G24D-3	1000	4000	80	360	×	171	35	30000

Existing control gear needs to be bypassed. Please refer to usage instructions.

ORDERING CODES - NAV LED LAMP



Product Name	EAN	Model Number	No.	W	lm	K	Ra	°	mm	mm	mm	mm
--------------	-----	--------------	-----	---	----	---	----	---	----	----	----	----

NAV LED FILAMENT

NAV 50 LED FIL V 3600LM 21W 727 E27LEDV	4099854071973	NAV5021W727E27	01	21	E27	3600	2700	70	360	×	170	38	25000
NAV 50 LED FIL V 4000LM 21W 740 E27LEDV	4099854071997	NAV5021W740E27	01	21	E27	4000	4000	70	360	×	170	38	25000
NAV 70 LED FIL V 5400LM 35W 727 E27LEDV	4099854072017	NAV7035W727E27	02	35	E27	5400	2700	70	360	×	210	38	25000
NAV 70 LED FIL V 6000LM 35W 740 E27LEDV	4099854072031	NAV7035W740E27	02	35	E27	6000	4000	70	360	×	210	38	25000
NAV 100 LED FIL V 7000LM 41W 727E40LEDV	4099854072055	NAV10041W727E40	03	41	E40	7000	2700	70	360	×	225	46	25000
NAV 100 LED FIL V 7500LM 41W 740E40LEDV	4099854072079	NAV10041W740E40	03	41	E40	7500	4000	70	360	×	225	46	25000

Direct replacement for traditional NAV lamps, thanks to CCG compatibility, no rewiring needed.

ORDERING CODES - LED TUBE



Product Name	EAN	Model Number	No.	W	mm	lm	K	Ra	°	mm	mm	mm	mm	t(h)
--------------	-----	--------------	-----	---	----	----	---	----	---	----	----	----	----	------

LED TUBE T9 EM V

LEDTUBE T9C EM V 22 11W 865 G10Q LEDV	4099854042485	T9CEM2211W865G10Q	01	11	G10Q	1320	6500	80	110	×	212	29	30000
LEDTUBE T9C EM V 32 18.3W 865 G10Q LEDV	4099854042546	T9CEM3218.5W865G10Q	02	18.3	G10Q	2200	6500	80	110	×	300	29	30000

SUBSTITUBE ADVANCED T8 EM

ST8A-1.2M 14W/840 220-240V EM G9	4058075392786	OSRST8A-1.2M14W840G9	03	14	G13	2100	4000	80	160	×	1212	26	50000
ST8A-1.2M 14W/865 220-240V EM G9	4058075392809	OSRST8A-1.2M14W865G9	03	14	G13	2100	6500	80	160	×	1212	26	50000

WARRANTY POLICY

Your LED Light Fitting from LEDVANCE comes with a product warranty (“Warranty”) for quality assurance, the terms and conditions of which are set out in this document.

The Warranty applies exclusively to LED Light Fittings from LEDVANCE purchased within Australia.

The Warranty is offered to you by
LEDVANCE Pty Ltd at
Unit 3, 83 Derby St,
Silverwater NSW 2128

Phone: 1300 467 726
Email address: technical.au@ledvance.com

IMPORTANT:

Our goods come with guarantees that cannot be excluded under the Australian Consumer Law. You are entitled to a replacement or refund for a major failure and compensation for any other reasonably foreseeable loss or damage. You are also entitled to have the goods repaired or replaced if the goods fail to be of acceptable quality and the failure does not amount to a major failure.

1. DEFINITIONS

In this warranty:

- 1.1 “ACL” means Australian Consumer Law which is set out in Schedule 2 of the Competition and Consume Act 2010
- 1.2 “LEDVANCE” means LEDVANCE Pty Ltd
ABN 34 050 103 181
- 1.3 “Product” means PRODUCT fitting from LEDVANCE listed as a product in the schedule at clause 3.1 below that is covered by the terms of the Warranty as set out in this document.
- 1.4 “You” or “Your” means the original end-user purchaser of the Product.

2. HOW LEDVANCE WILL HONOR THE WARRANTY

- 2.1 Subject to Your consumer rights under the ACL, if the Product fails to operate during the Warranty Period, LEDVANCE has the option to:
 - Repair or replace the faulty components or parts; or
 - Pay for the repair or replacement of the faulty components or parts; or
 - Purchased.
- 2.2 To obtain the benefits under the Warranty, You must provide the original proof of purchase or sales receipt.

3. WARRANTY PERIOD

- 3.1 The period in which Your PRODUCT fitting is covered by the Warranty is 5 years for all standard luminaires (or lifetime in hours, see specific products technical data for more information)
- 3.2 All general lighting products with lithium battery holds the standard 5 years warranty on the luminaire (or lifetime in hours) and 1 year on the battery (excluding emergency range)
- 3.3 All Emergency products with lithium battery (excluding general lighting) have a warranty period of 5 years on the luminaire and 3 years on the lithium battery.

4. WARRANTY DETAILS

4.1 Subject to Your rights under the ACL, the Warranty only applies under the following conditions:

- The product is properly installed or installed consistent with the manufacturer's instructions, or installed by a suitably trained and qualified installer the product is used for the proper design purpose of illumination
- The product is used in normal conditions, where the limits of temperature values, switching cycles and voltage values are not exceeded (please refer to Product Data Sheet)
- The product is not subject to unauthorized modification, alteration or repair
- The product failure was caused by material, design or production faults

4.2 The Warranty DOES NOT COVER:

- Damage that is only cosmetic in nature where the functional properties of the product is not affected
- Damage that is attributable to misuse, negligence, abuse or accidental damage
- Damage that is caused by exposure to moisture and/or chemicals such as bleach or cleaning solutions
- Damage that is caused by civil disturbances, theft, fire or acts of nature, including but not limited to floods and lightning
- Damage that is caused by the use of an accessory component or equipment that is not supplied by the LEDVANCE Group

5. CLAIM PROCESS

5.1 To make a claim under the Warranty customers can take the following actions:

Telephone LEDVANCE on 1300 467 726

Email LEDVANCE on claims.au@ledvance.com

Send the faulty product along with the proof of purchase (such as a receipt of purchase) to the address provided by our sales team. (Returns sent to our head office will not be accepted and will be returned to sender)

Upon receipt of the faulty product and proof of purchase, LEDVANCE will assess the faulty product and the claim.

If LEDVANCE accepts the claim as valid, LEDVANCE will provide an equivalent replacement product or provide a refund of the amount stated in the proof of purchase.

If LEDVANCE determines the claim to be invalid, LEDVANCE will provide you with an explanation and if requested the faulty product will be returned.

6. RESPONSIBILITY FOR EXPENSE OF CLAIM OR LOSS

6.1 It is your responsibility to cover any expense associated with the claim, including:

- Freight charges or postage of the faulty product to LEDVANCE;
- The cost of labour or equipment required for the removal or replacement of the faulty product; and
- Any other costs associated with or arising out of the repair or replacement.

6.2 Subject to your rights under the ACL, LEDVANCE is not responsible for any compensation of damages or loss of profits that are not covered under this Warranty.

PRODUCT WARRANTY

LUMINAIRES*



- Blade Batten
- Canopy Light
- Commercial Downlight
- Eco Panel
- Eco Solar Streetlight
- Floodlight Max
- High Output Panel
- High Power Floodlight
- IP20 Electronic Transformer 60W
- IP65 Bulkhead
- Linkable Batten
- Mini Batten
- Modular Downlight
- Orbis Ultra Slim Oyster
- Panel Plus
- Performance Highbay
- PIR and Microwave Sensors
- Security Floodlight
- Solar Streetlight
- Streetlight Flex
- Superstar Downlight
- Superstar Gimble Downlight
- Superstar Slim Downlight
- Superstar Tri Colour Gimble Downlight
- Surface Mount Downlight
- Surface Mount Frame
- Theseus
- Tri Colour Multi Wattage Batten - Slim
- Tri Colour Multi Wattage Batten - Wide
- Tri Colour Multi Wattage Floodlight - Low Power
- Tri Colour Multi Wattage Floodlight - Mid Power
- Tri Colour Multi Wattage Highbay
- Tri Colour Multi Wattage Weatherproof Batten
- Tri Colour Oyster
- Ultra Commercial Downlight
- Universal Panel Accessories
- Value Dimmers
- Wide Weatherproof Batten

LAMPS*



- HQL Lamps
- NAV-T Lamps



- LED Lamps



- Traditional Lamps

Additional warranties can be discussed on a project-by-project basis.

*Warranties are only valid if installed as per the usage instruction. Incorrect installation or site specific failures may result warranties being void.

ABOUT LEDVANCE

With offices in more than 50 countries and business activities in more than 140 countries, LEDVANCE is one of the world's leading general lighting providers for professional users and end consumers. Having emerged from the general lighting business of OSRAM GmbH, LEDVANCE offers a wide-ranging assortment of LED luminaires for a broad spectrum of application areas, intelligent lighting products for Smart Homes and Buildings, one of the largest LED lamps portfolios in the industry as well as traditional light sources.



LEDVANCE

Customer Service
Phone: 1300 467 726
E-mail: sales.au@ledvance.com

LEDVANCE Pty Ltd
Unit 3, 83 Derby St
Silverwater NSW 2128
Australia

LEDVANCE LIGHTING SOLUTIONS V1 09/07/24

LEDVANCE is licensee of product trademark
OSRAM for lamps products in general lighting.

LEDVANCE.COM.AU

