

DALI MCU
Digital rotary dimmer
Online-Training

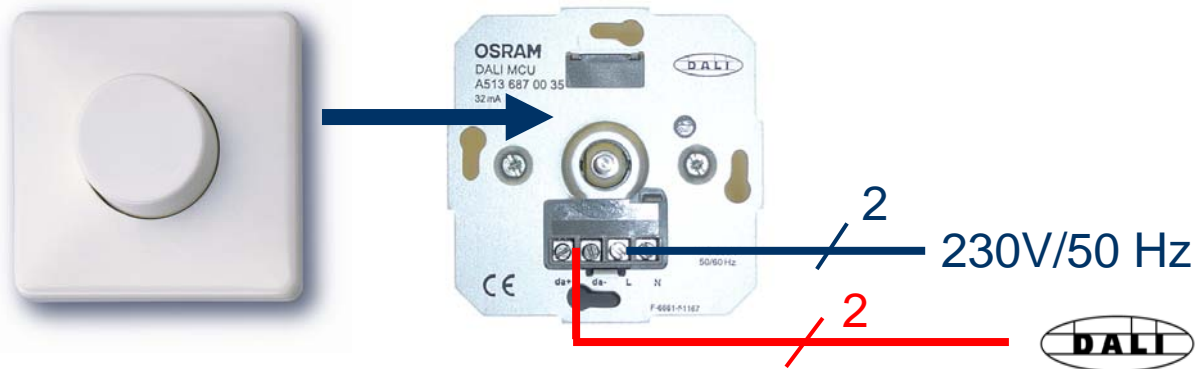

DALI MCU digital rotary dimmer General



- The DALI MCU ist a rotary dimmer with DALI output for dimming of luminaires- or transformers with DALI interface
- Dimming solutions are easy realisable, no DALI adresssing necessary
- The DALI MCU is adaptable in all standard switches, operation point extension by easy parallel connection

DALI MCU digital rotary dimmer Handling



- Usage of existing cover

DALI MCU digital rotary dimmer Handling

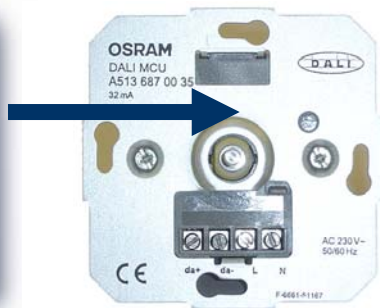

- Usage of existing cover

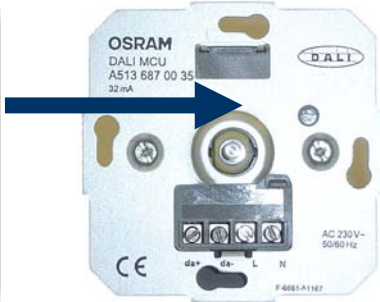

- Easy integration in standard switches

DALI MCU digital rotary dimmer Operation



- On/off – press
- Brightness – rotate

Special functions

- configure switch-on brightness – double click
- Set/cancel minimum basic brightness – push knob until blinking confirmation

DALI MCU digital rotary dimmer Wiring diagram

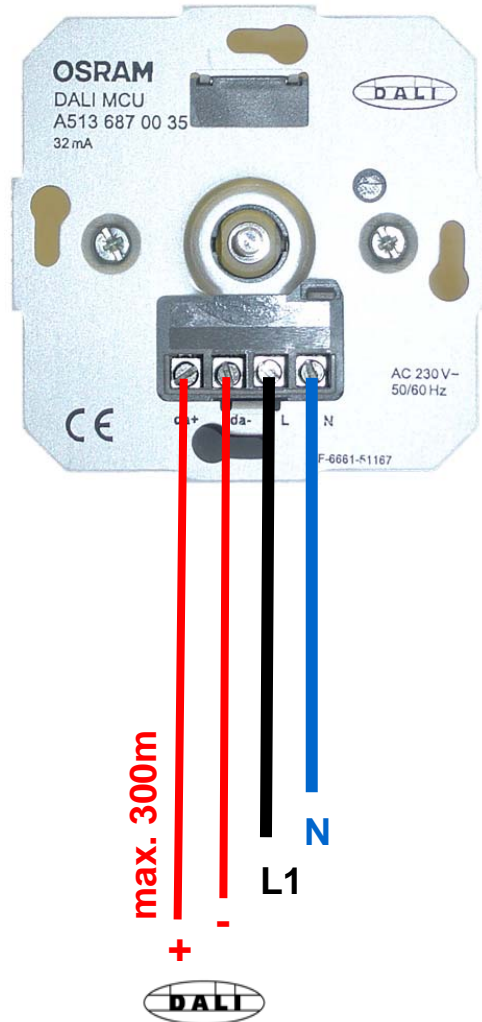

DALI MCU digital rotary dimmer Wiring diagram

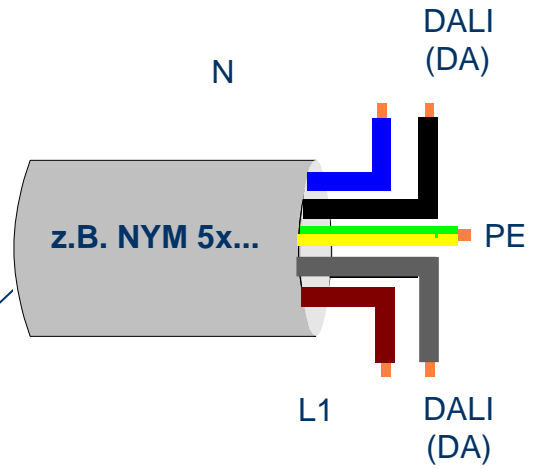
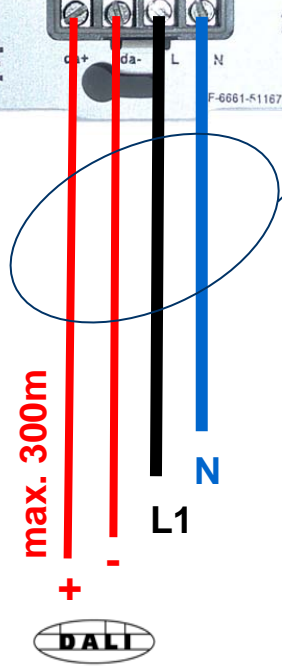
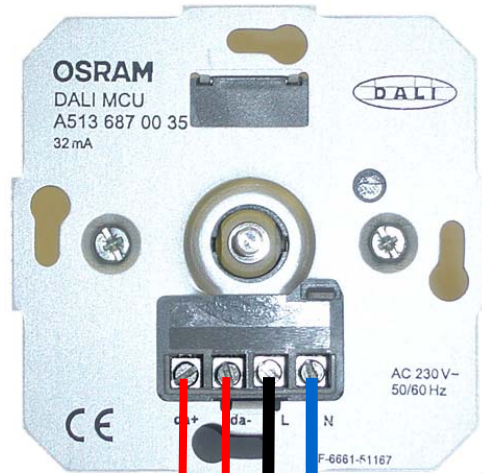

- DALI control cable as part of a sheathed cable

DALI MCU digital rotary dimmer

Wiring diagram with 1 operation point

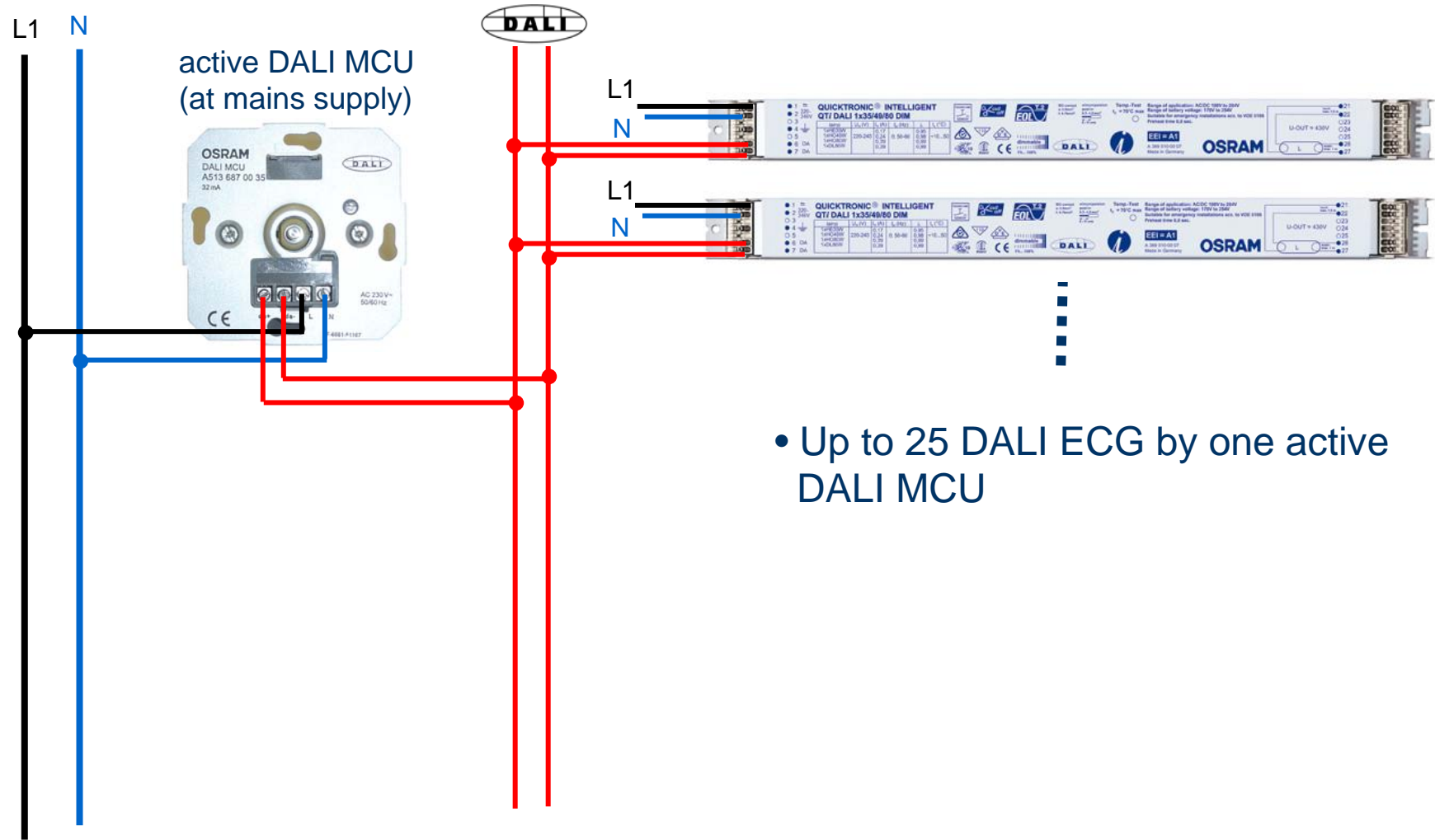

- Up to 25 DALI ECG by one active DALI MCU

DALI MCU digital rotary dimmer

Wiring diagram with 2 operation points

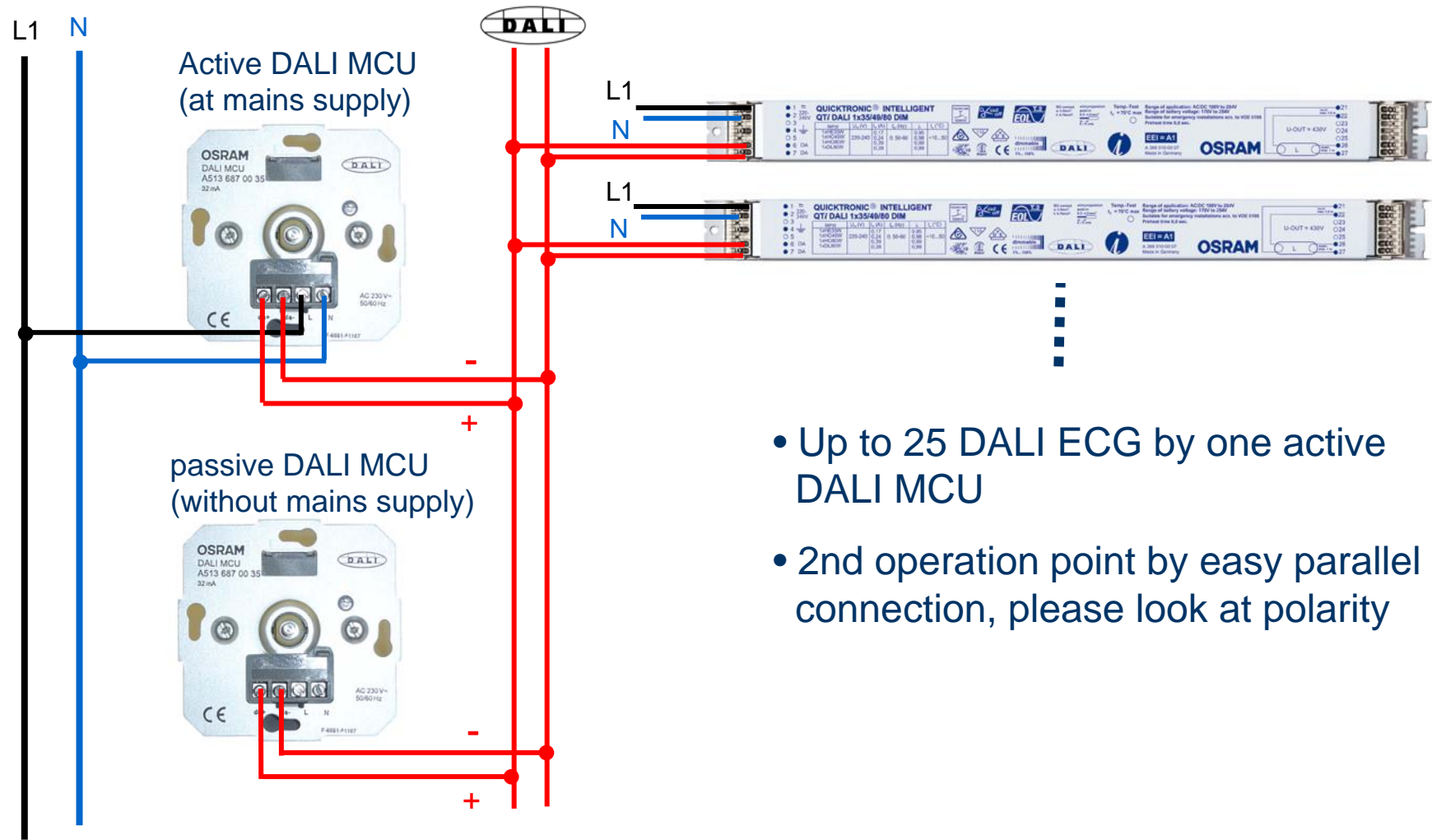

- Up to 25 DALI ECG by one active DALI MCU
- 2nd operation point by easy parallel connection, please look at polarity

DALI MCU digital rotary dimmer Wiring diagram with 2 operation points

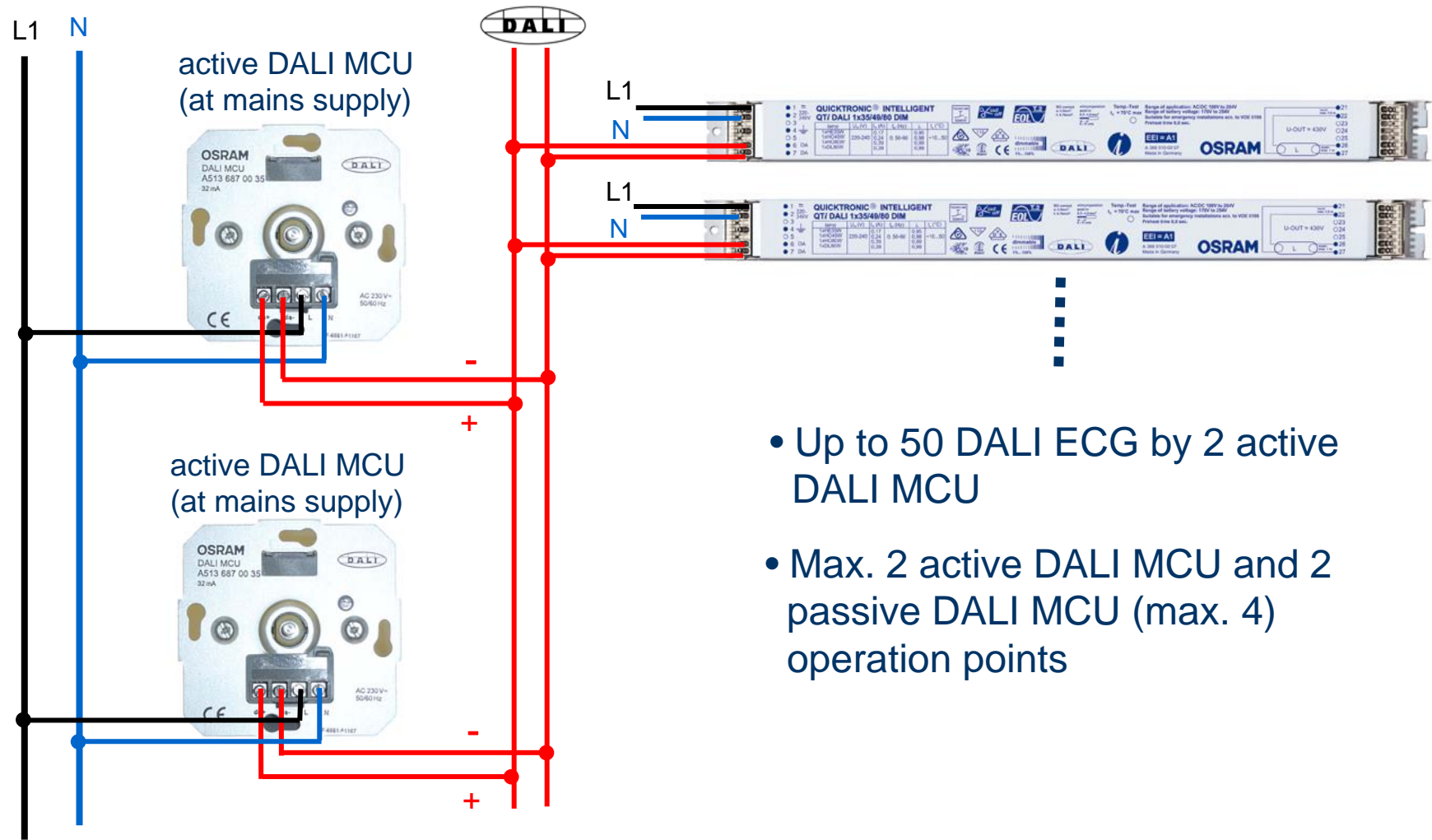

- Up to 50 DALI ECG by 2 active DALI MCU
- Max. 2 active DALI MCU and 2 passive DALI MCU (max. 4) operation points

DALI MCU digital rotary dimmer

Application example with 2 operation points

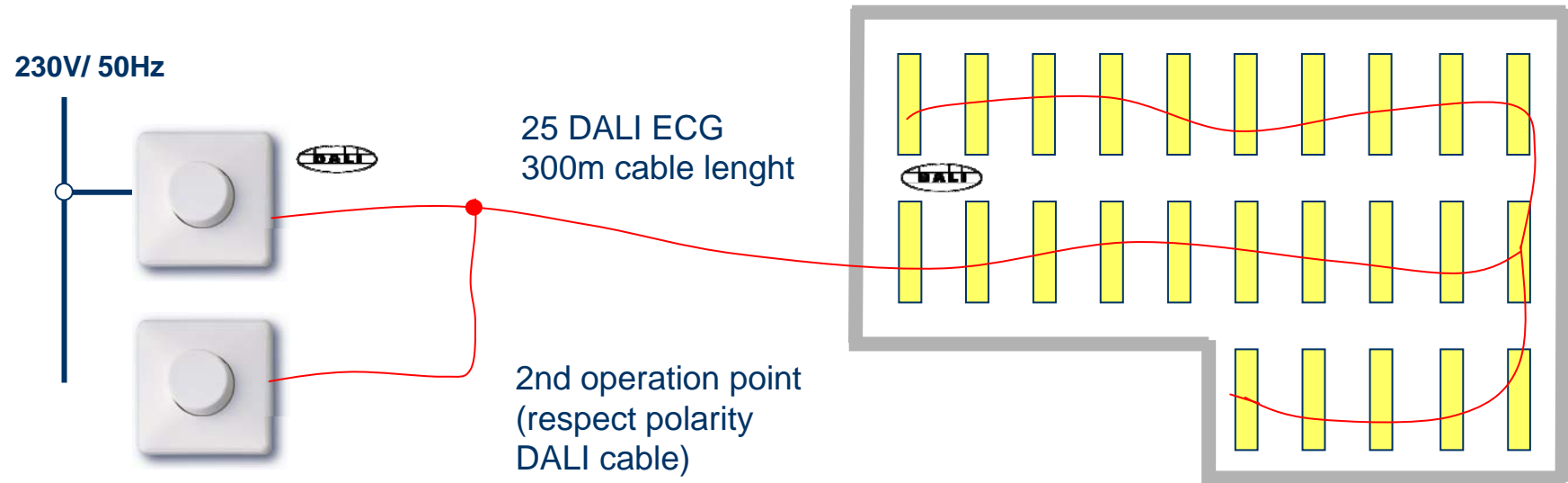

DALI MCU digital rotary dimmer

Application example with 2 operation points

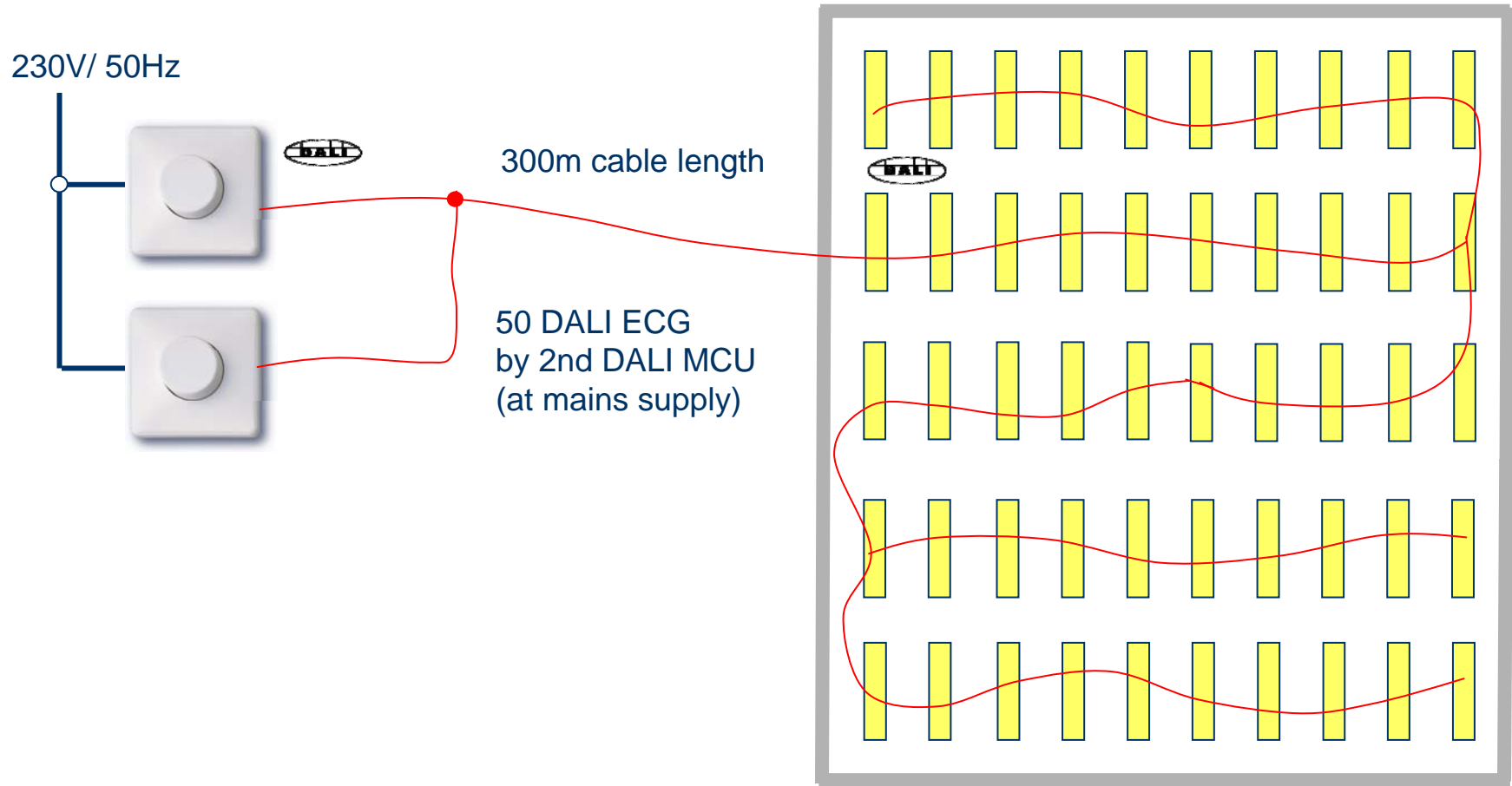

DALI MCU digital rotary dimmer

Application example with 4 operation points

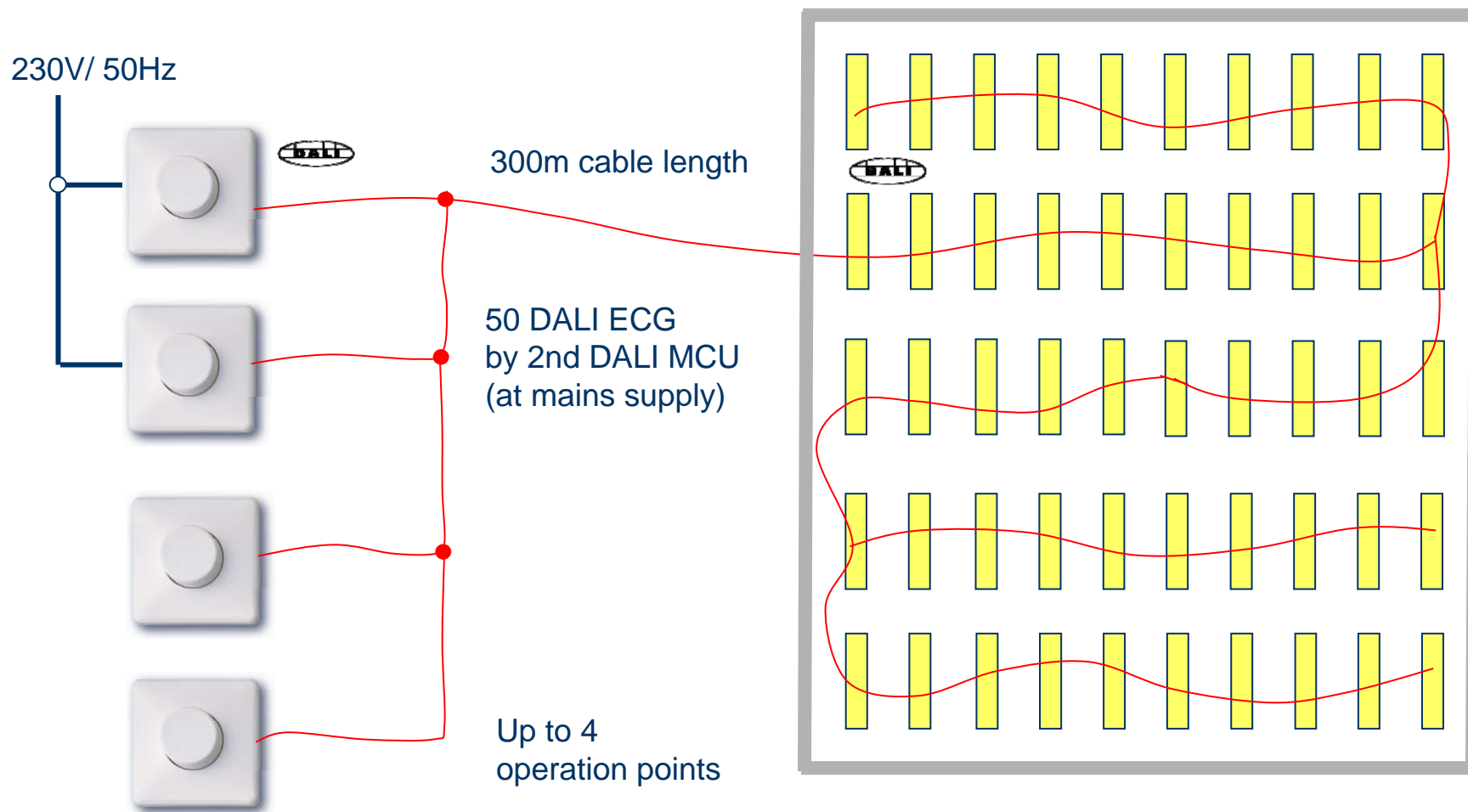

DALI MCU digital rotary dimmer

Application example with 4 operation points

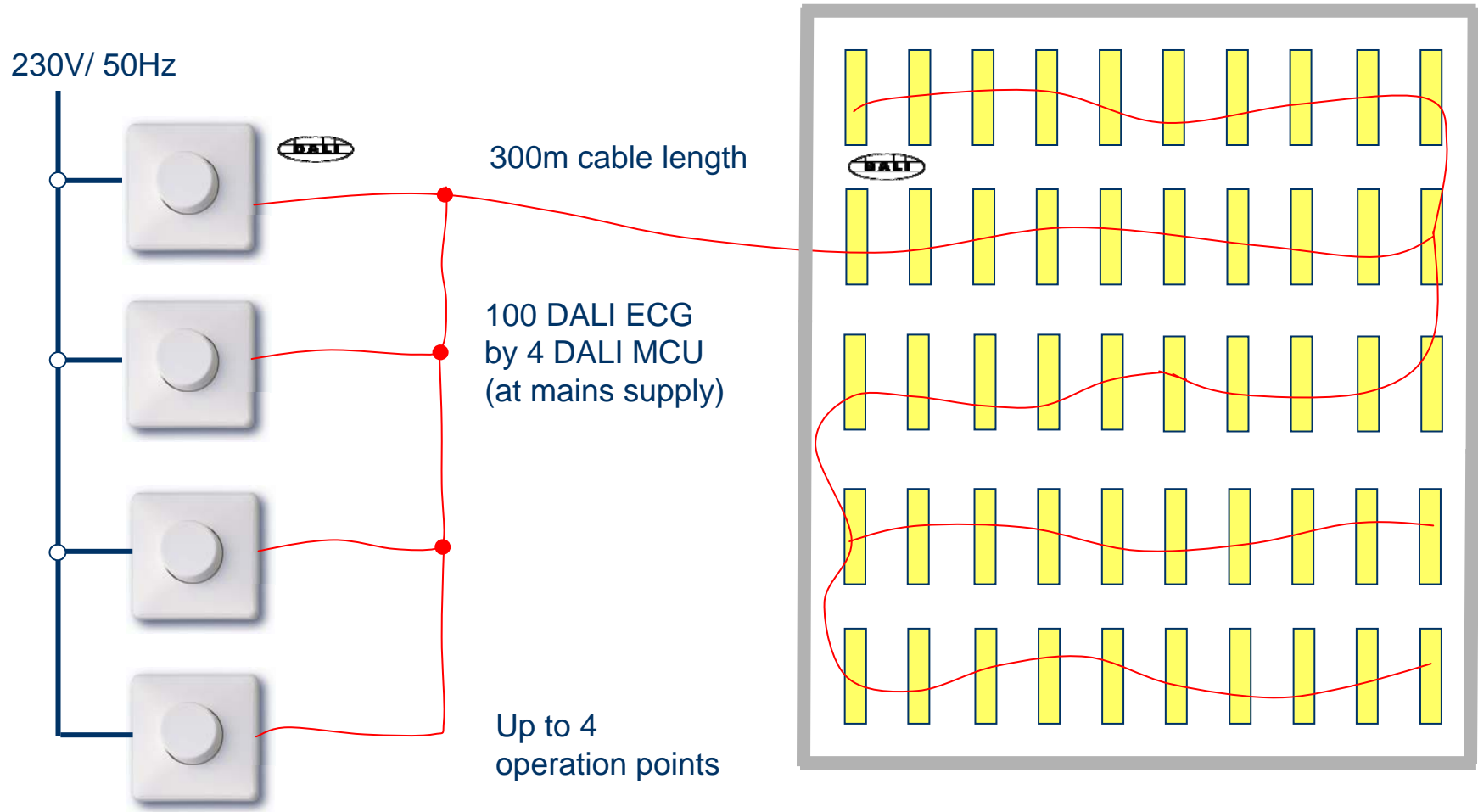

DALI MCU digital rotary dimmer

Application example with flexible partition wall

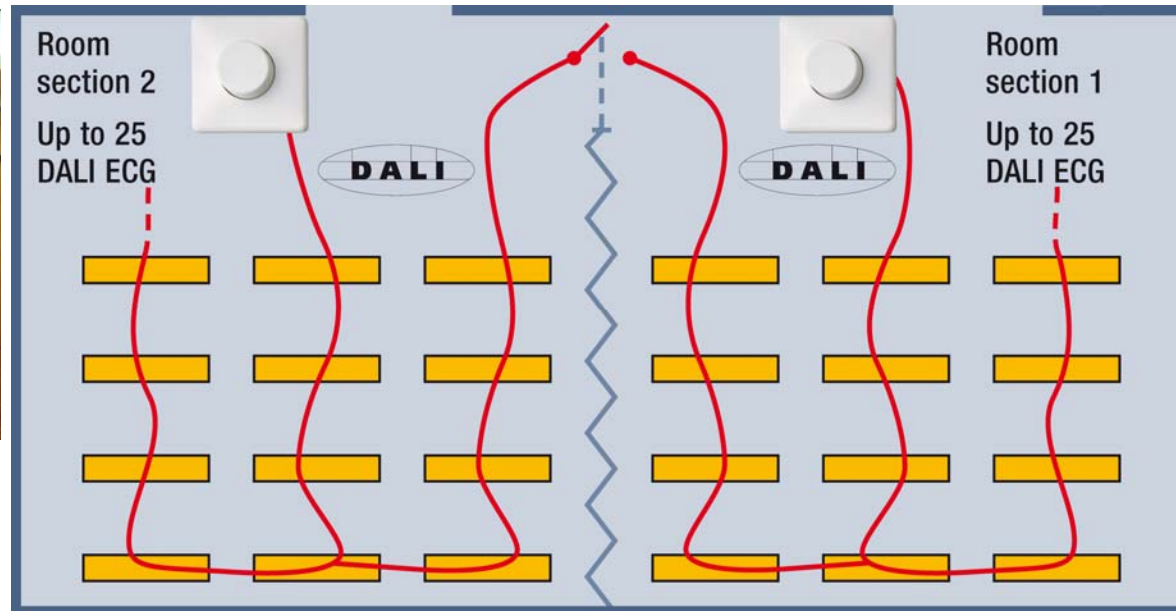

Principle:

- Partition wall closed, limit switch open
- Discrete rooms, operation seperately

DALI MCU digital rotary dimmer

Application example with flexible partition wall

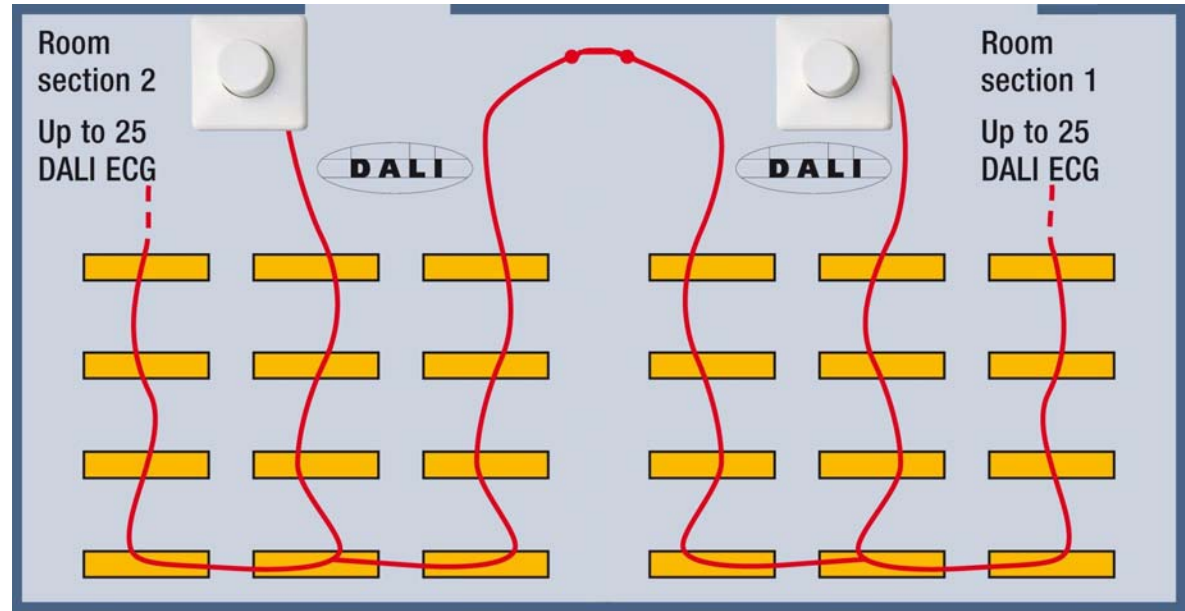

Principle:

- Partition wall open, limit switch closed
- Connected room with 2 operation points

DALI MCU digital rotary dimmer



Additional informations:

www.osram.com/ecg-lms

www.osram.com/systemguarantee

**We wish you a great
sucsess with the DALI MCU**