

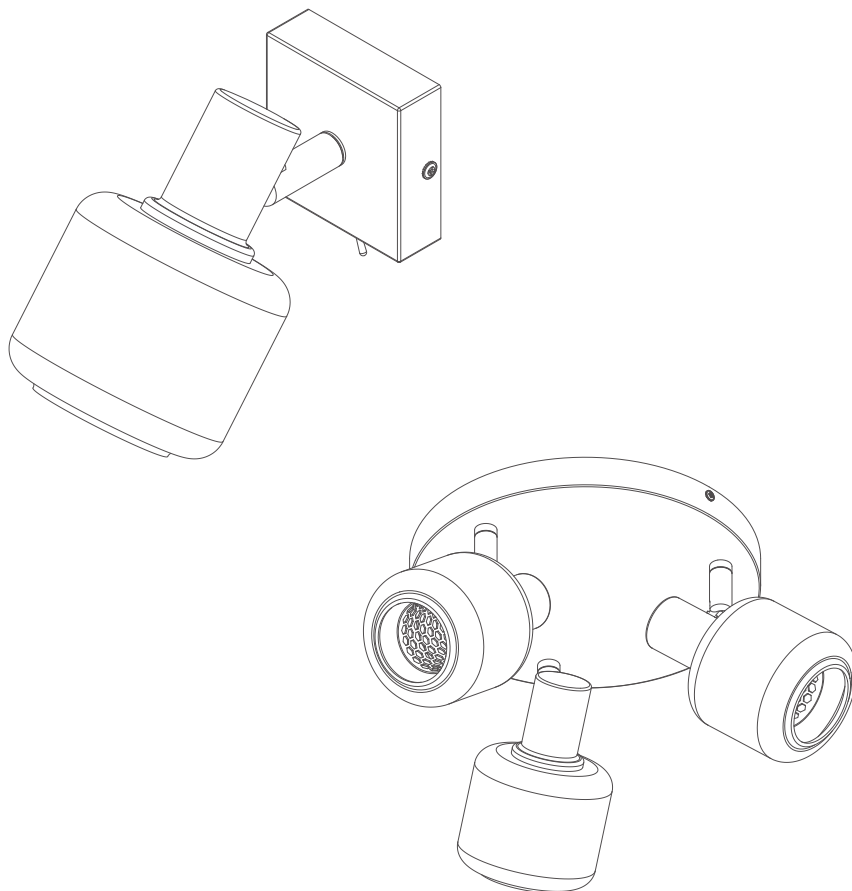

# DECOR SPOT FIREFLY



LEDVANCE



	EAN	W	Max. W LED	Im Light Source	Im Output	K	IP	⊖ (°C)	V~	mA	Hz	DF	
DECOR SPOT FIREFLY 1X2.8W 827 E14BK	4058075838017	2.8	10W	250	250	2700	20	-20...+40	220-240	13	50/60	—	100000
DECOR SPOT FIREFLY PL 3X2.8W E14 BK	4058075838093	3x2.8	3x10W	3x250	750	2700	20	-20...+40	220-240	39	50/60	>0.9	100000

# DECOR SPOT FIREFLY

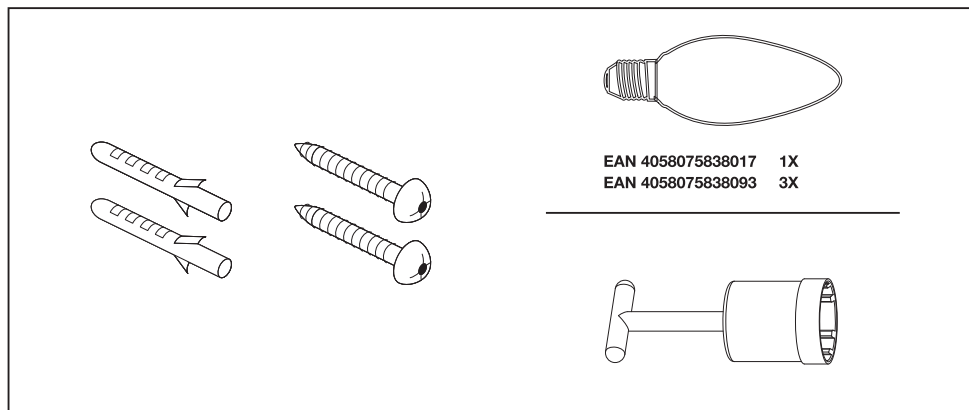
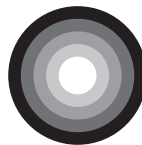

**380 g** A  
EAN 4058075838017

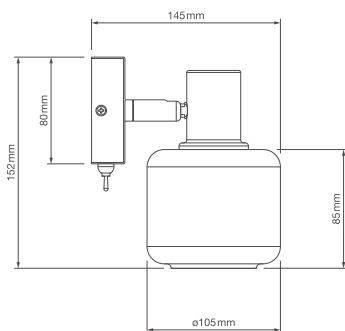

**1230 g** B  
EAN 4058075838093

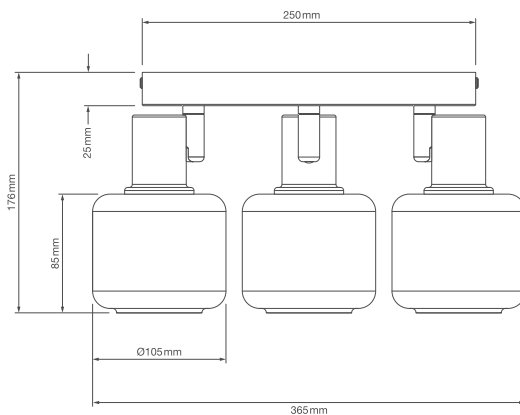

# DECOR SPOT FIREFLY



1A

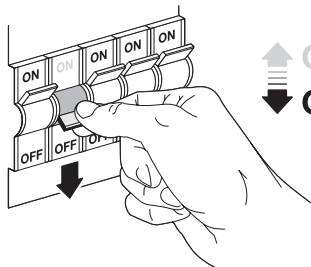

↑ ON  
↓ OFF

2A

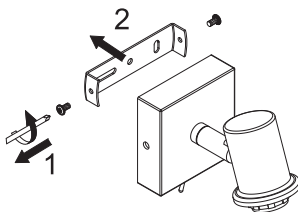

3A

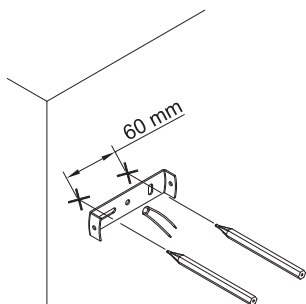

1) Check wall/ceiling for suitability. If uncertain, seek professional advice.

4A

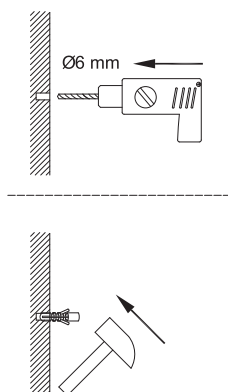

5A

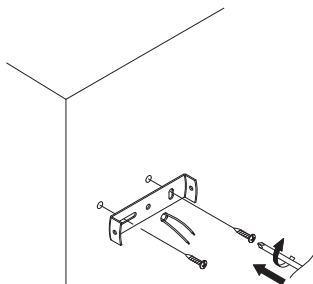

6A

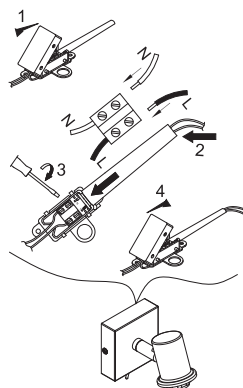

# DECOR SPOT FIREFLY



7A

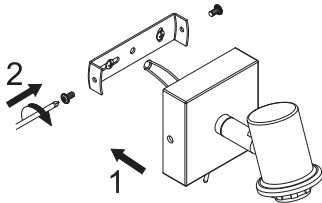
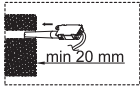

8A

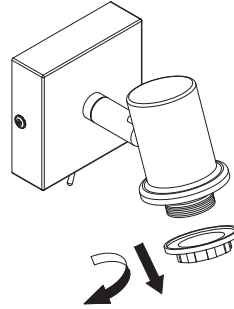

9A

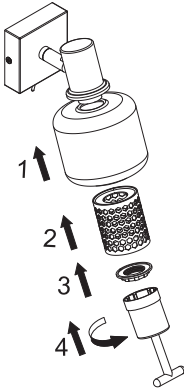

10A

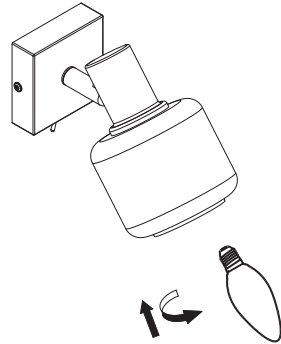

11A

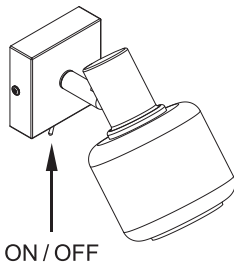

12A

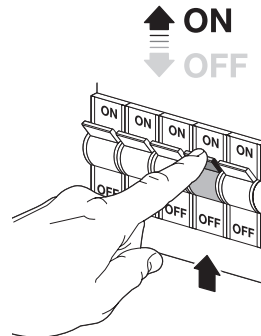



# DECOR SPOT FIREFLY

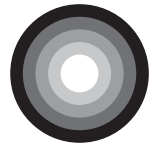

7B

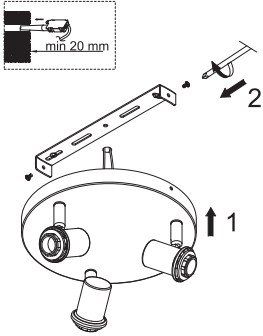

8B

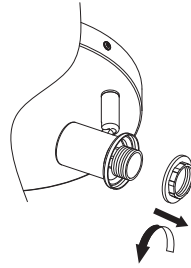

9B

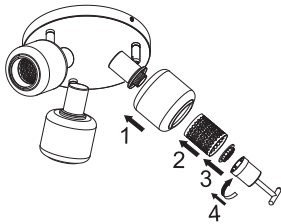

10B



11B

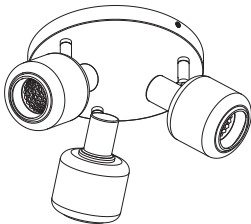



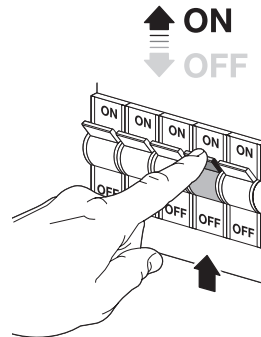

12B



# DECOR SPOT FIREFLY



						 <b>ENERGY</b> * X =
DECOR SPOT FIREFLY 1X2.8W 827 E14BK	4058075838017	1	AC32304		F	
DECOR SPOT FIREFLY PL 3X2.8W E14 BK	4058075838093	3	AC32304		F	

\*

(D) Dieses Produkt enthält eine Lichtquelle der Energieeffizienzklasse <X>. (GB) This product contains a light source of energy efficiency class <X>. (F) Ce produit contient une source lumineuse de classe d'efficacité énergétique <X>. (I) Questo prodotto contiene una sorgente luminosa di classe di efficienza energetica <X>. (E) Este producto contiene una fuente luminosa de la clase de eficiencia energética <X>. (P) Este produto contém uma fonte de luz da classe de eficiência energética <X>. (GR) Το προϊόν αυτό περιέχει φωτεινή πηγή της τάξης ενεργειακής απόδοσης <X>. (NL) Dit product bevat een lichtbron van energie-efficiëntieklasse <X>. (S) Denna produkt innehåller en ljuskälla med energieeffektivitetsklass <X>. (FIN) Tämä tuote sisältää valonlähteen, jonka energiatehokkuusluokka on <X>. (N) Dette produktet inneholder en lyskilde med energieffektivitetsklasse <X>. (DK) Dette produkt indeholder en lyskilde i energieffektivitetsklasse <X>. (CZ) Tento výrobek obsahuje světelný zdroj s třídou energetické účinnosti <X>. (RU) Данный продукт содержит энергосберегающий источник света (класса <X>). (H) Ez a termék egy <X> energiahatékonysági osztályú fényforrást tartalmaz. (PL) Ten produkt zawiera źródło światła o klasie efektywności energetycznej <X>. (SK) Tento výrobok obsahuje svetelný zdroj triedy energetickej účinnosti <X>. (SI) Ta izdelek vsebuje svetlobni vir razreda energijske učinkovitost <X>. (TR) Bu ürün, enerji verimliliği sınıfında bir ışık kaynağı içerir <X>. (HR) Ovaj proizvod sadržava izvor svjetlosti klase energetske učinkovitosti <X>. (RO) Acest produs conține o sursă de lumină cu clasa de eficiență energetică <X>. (BG) Този продукт включва светлинен източник с клас на енергийна ефективност <X>. (EST) Toode sisaldab energiatõhususe klassi <X> valgusallikat. (LT) Šiame gaminyje yra šviesos šaltinis, kurio energijos vartojimo efektyvumo klasė <X>. (LV) Ši s ražojums satur gaismas avotu, kura energoefektivitātes klase ir <X>. (SRB) Ovaj proizvod sadrži izvor svetlosti klase energetske efikasnosti <X>. (UA) Цей виріб містить джерело світла класу енергоефективності <X>. (KZ) Бұл өнімде <X> энергия тиімділігі класының жарық көзі бар.

(D) 1) Eignung der Wand/Decke prüfen. Wenn Sie sich nicht sicher sind, lassen Sie sich beraten. (GB) 1) Check wall/ceiling for suitability. If uncertain, seek professional advice. (F) 1) Vérifiez l'adéquation du mur/plafond. En cas d'incertitude, demandez conseil à un professionnel. (I) 1) Controllare l'idoneità della parete o del soffitto. In caso di dubbi, consultare un professionista. (E) 1) Compruebe la idoneidad de la pared o techo. Si no está seguro, busque asesoramiento profesional. (P) 1) Verifique a adequação da parede/teto. Se não tiver a certeza, procure aconselhamento profissional. (GR) 1) Ελέγξτε τον τοίχο/την οροφή ως προς την καταλληλότητα. Σε περίπτωση αμφιβολίας, ζητήστε επαγγελματική συμβουλή. (NL) 1) Controleer wand/plafond op geschiktheid. Als u niet zeker bent, vraag dan professioneel advies. (S) 1) Kontrollera vägg/tak för lämplighet. Om du är osäker, sök professionell rådgivning. (FIN) 1) Tarkista seinän/katon sopivuus. Jos olet epävarma, kysy neuvoa ammattilaiselta. (N) 1) Sjekk om veggen/taket egner seg. Oppsøk profesjonell rådgivning dersom du er usikker. (DK) 1) Kontrollervæg/loftfor egnethed. Hvis du er usikker, skal du søge professionel rådgivning. (CZ) 1) Zkontrolujte vhodnost stěny/stropu. Pokud si nejste jisti, vyhledejte odbornou radu. (RUS) 1) Проверьте стену/потолок на пригодность. Если у вас есть сомнения, обратитесь за профессиональной консультацией. (H) 1) Ellenőrizze a fal/mennyezet alkalmasságát. Ha bizonytalan, kérjen szakszerű tanácsot. (PL) 1) Sprawdź, czy ściana/sufit nadają się do montażu. W razie wątpliwości zasięgnij porady wykwalifikowanej osoby. (SK) 1) Skontrolujte vhodnosť steny/stropu. Ak si nie ste istí, vyhľadajte odbornú pomoc. (SLO) 1) Preverite primernost stene/stropa. Če niste prepričani, poiščite nasvet strokovnjaka. (TR) 1) Duvarın/tavanın uygun olup olmadığını kontrol edin. Emin değilseniz uzman bir kişiden destek alın. (HR) 1) Provjerite prikladnost zida/stropa. Ako niste sigurni, potražite stručni savjet. (RO) 1) Verificați dacă peretele/tavanul este adecvat. În caz de incertitudine, solicitați consultanță de specialitate. (BG) 1) Проверете пригодността на стената/тавана. Ако не сте сигурни, потърсете професионален съвет. (SE) 1) Kontrolli seinale/lakke sobivust. Kahtluse korral küsi professionaalilt nõu. (LT) 1) Patikrinkite sienos/lubų tinkamumą. Jei kyla abejonių, kreipkitės į specialistą. (LV) 1) Pārbaudiet sienu/griestu piemērotību. Neskaitību gadījumā meklējiet profesionālu padomu. (SRB) 1) Proverite pogodnost zida/plafona. Ako niste sigurni, potražite stručni savet. (UA) 1) Перевірте відповідність стіни/стелі. Якщо ви не впевнені, зверніться за професійною консультацією. (KZ) 1) Қабырғаның/төбенің жарамдылығын тексеріңіз. Егер сенімді болмасаңыз, кәсіби кеңеске жүгініңіз.

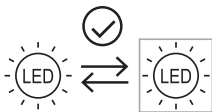
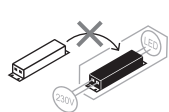

LEDVANCE GmbH  
 Steinerne Furt 62  
 86167 Augsburg, Germany  
[www.ledvance.com](http://www.ledvance.com)

C10449058  
 G11199043

31.05.24

Points de collecte sur [www.quefairedemesdechets.fr](http://www.quefairedemesdechets.fr)

(GB) LEDVANCE Ltd, Sterling House,  
 810 Mandarin Court, Warrington,  
 Cheshire, WA1 1GG, United Kingdom