

---

# BATTERY UVC LED DISINFECTION BOX

---

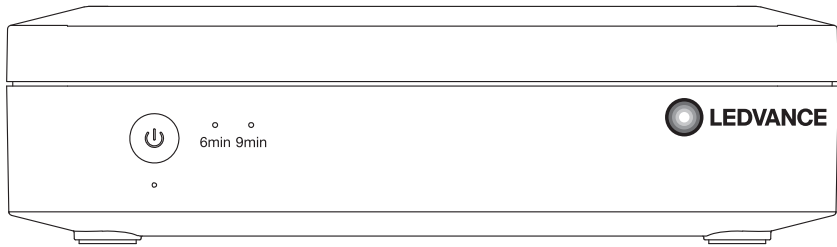

	EAN	W	Δ (°C)	V~	A	nm	mW	Mode	Port
<b>BATTERY UVC LED DISINFECTION BOX</b>	4058075515994	5	-20 - +40	5	1	270-280	4x4	4 x UVC-LED	Type-C USB

**BATTERY UVC LED DISINFECTION BOX**

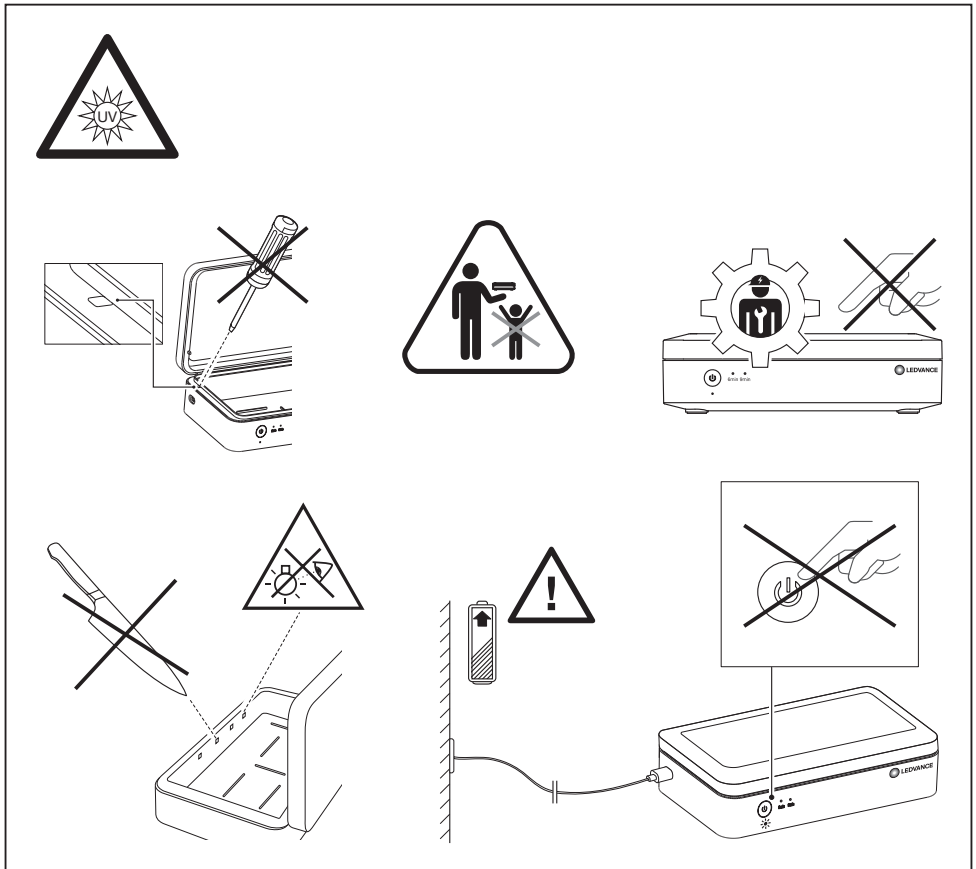
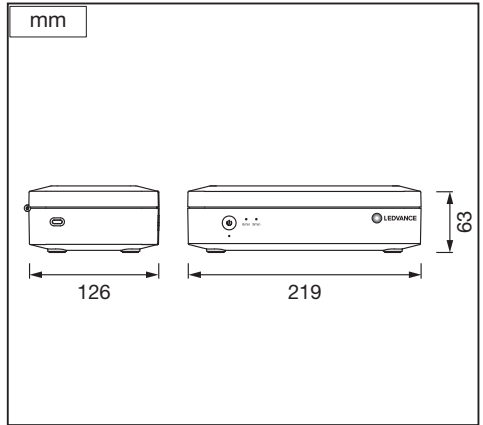
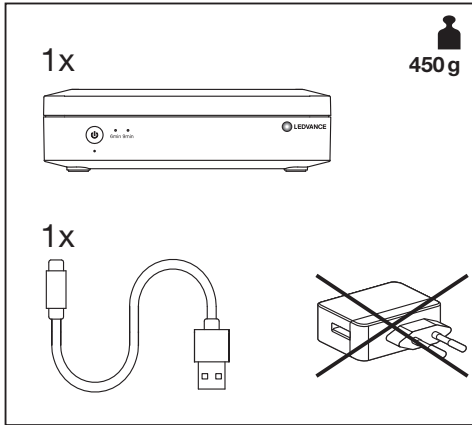

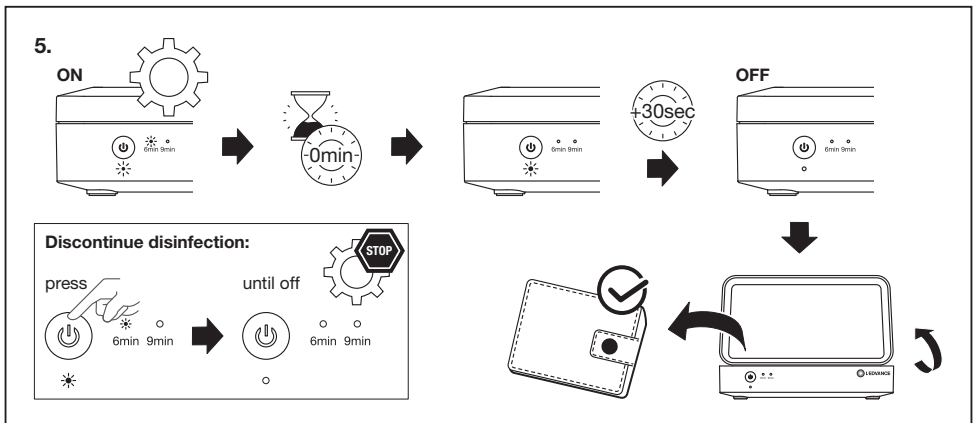
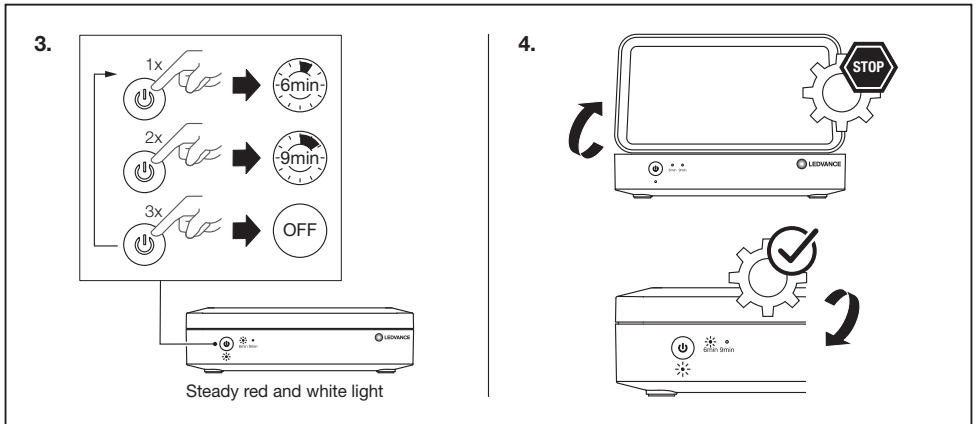
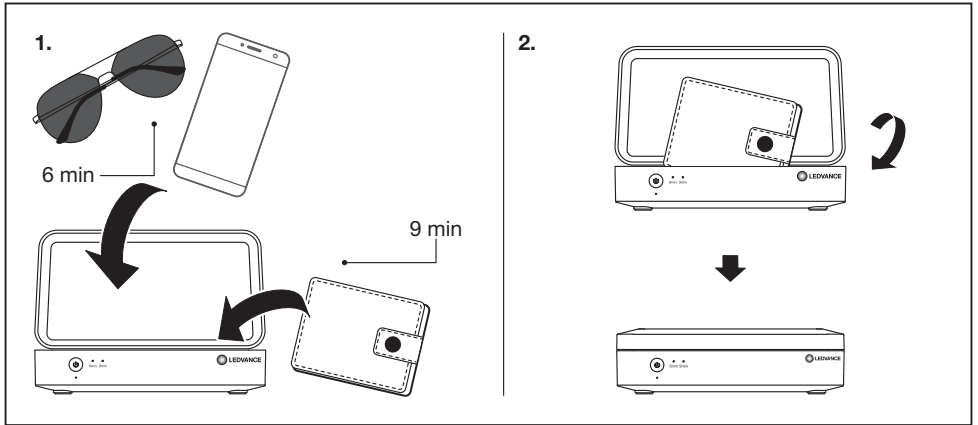

### Battery/Charging

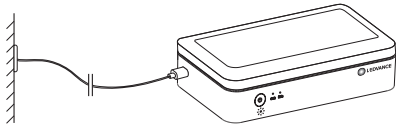

Max. 25x

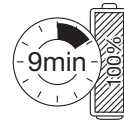

Max. 16x

Flashing green light:



Flashing red light:



Steady green light:

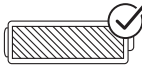

Steady red and white light:



### UVC Disinfection of Some Common Bacteria

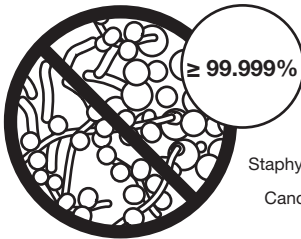

Escherichia coli  
Staphylococcus aureus  
Candidiasis albicans\*



### UVC RISK GROUP: EXEMPT

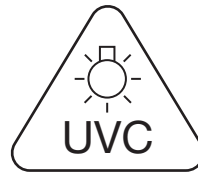

Ⓢ Dies ist kein medizinisches Gerät. Ⓢ This is not a medical device. Ⓢ Ceci n'est pas un dispositif médical. Ⓢ Questo non è un dispositivo medico. Ⓢ Este no es un dispositivo médico Ⓢ Este não é um dispositivo médico. Ⓢ Αυτό το προϊόν δεν είναι ιατρική συσκευή. Ⓢ Dit is geen medische apparatuur. Ⓢ Detta är inte någon medicinsk utrustning. Ⓢ Tämä ei ole lääkintälaitte. Ⓢ Dette er ingen medisinsk enhet. Ⓢ Dette er ikke medicinsk udstyr. Ⓢ Toto není zdravotnický prostředek. Ⓢ Ἔτο не медицинское изделие. Ⓢ A termék nem orvostechnikai eszköz. Ⓢ Ten produkt nie jest wyrobem medycznym. Ⓢ Toto nie je zdravotnícka pomôcka. Ⓢ То ni медицински припоmocек. Ⓢ Bu ürün tibbi bir cihaz değildir. Ⓢ Ovo nije medicinski proizvod. Ⓢ Acesta nu este un dispozitiv medical. Ⓢ Това не е медицинско изделие. Ⓢ See ei ole meditsiiniseade. Ⓢ Tai nėra medicinos priemonė. Ⓢ Št nav medicinska ierice. Ⓢ Ovo nije medicinsko sredstvo. Ⓢ Це не медицинский вирiб. Ⓢ Бул – медициналық құрылғы емес.



C10449057  
G11117143  
31.03.2021



LEDVANCE GmbH  
Steinerne Furt 62  
86167 Augsburg, Germany  
www.ledvance.com