

# PRODUCT DATASHEET

## FL PFM 200 W 4000 K SYM 100 BK

FLOODLIGHT 200 W | Versatile floodlight with up to 25000 lm light output



### Areas of application

- Replacement for floodlights with halogen lamps
- Outdoor use (IP65)
- Industry
- Public areas
- Construction areas
- Building facades

### Product benefits

- Bright, robust and durable
- Safe and very uniform illumination, due to frosted and tempered glass diffuser
- No upper light output ratio (ULOR 0%) when mounted at 0° tilt
- Energy savings of up to 90 % compared to halogen lamp floodlights
- 5 years guarantee

### Product features

- Reflector-based, symmetric light distribution with 100° x 100° beam angle
- Integrated wide voltage driver, suitable for 100 - 277 V<sub>AC</sub>
- Surge protection: up to 6 kV (L/N-PE), 4 kV (L-N)
- Mounting bracket with 30° angle and wide rotation area
- Breather membrane to optimize air exchange, without compromising IP protection
- Pre-installed, flexible 1 m cable (H05RN-F), wrapped 3 x 1.0 mm<sup>2</sup> single wires



## TECHNICAL DATA

### Electrical data

Nominal wattage	200.00 W
Nominal voltage	100...277 V
Mains frequency	50...60 Hz
Nominal current	1000 mA
Inrush current	80 A
Inrush current time $T_{h50}$	1000 $\mu$ s
Max. number of luminaires per miniature circuit breaker B16	3
Max. number of luminaires per miniature circuit breaker C10	5
Max. number of luminaires per miniature circuit breaker C16	8
Power factor $\lambda$	> 0.90
Total harmonic distortion	< 20 %
Protection class	I
Operating mode	Integrated LED driver

### Photometrical data

Luminous flux	25000 lm
Luminous efficacy	125 lm/W
Color temperature	4000 K
Light color (designation)	Cool White
Color rendering index Ra	$\geq 80$
Standard deviation of color matching	$\leq 5$ sdc <sub>m</sub>
Luminous intensity	-
Low flicker	Yes
Flickering metric (Pst LM)	-
Stroboscope effect metric (SVM)	-
Photobiological safety group acc. to EN62778	RG1
Photobiological safety group acc. to EN62471	RG1
Beam angle	100 ° x 100 °



FL PFM 200W4000K SYM 100 BK

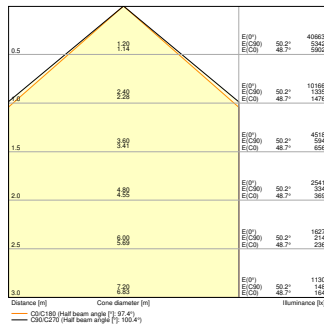

FL PFM 200W 4000K SYM 100 BK

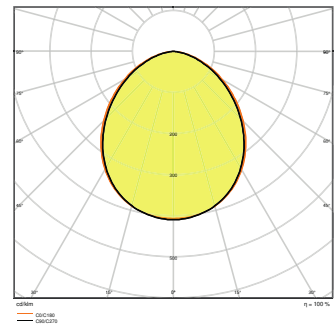

FL PFM 200W4000K SYM 100 BK

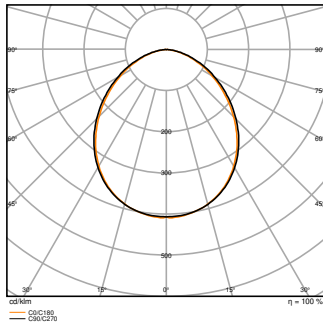

FL PFM 200W 4000K SYM 100 BK

Dimensions & Weight

Length	454.00 mm
Width	354.00 mm
Height	62.00 mm
Product weight	6000.00 g
Cable length	1000 mm

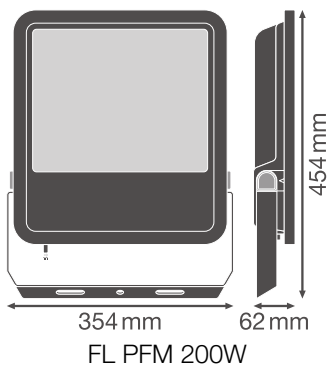

## Materials & Colors

Product color	Black
Housing color	Black
Body material	Aluminum
Light emitting surface material	Glass
Glow Wire Test according to IEC 60695-2-12	650 °C
Mercury content	0.0 mg

## Application & Mounting

Ambient temperature range	-30...+50 °C
Temperature range at storage	-40...+70 °C
Type of connection	Cable, 3-pole
Type of protection	IP65
Protection class IK (shock resistance)	IK08
Dimmable	No
Mounting type	Surface
Mounting location	Wall / Pole / Floor / Ceiling
Application environment	Outdoor
Adjustable	Yes
With light source	Yes

## Lifespan

Lifespan L70/B50 at 25 °C	70000 h <sup>1)</sup>
Lifespan L80/B10 at 25 °C	55000 h <sup>1)</sup>
Lifespan L80/B50 at 25 °C	55000 h
Lifespan L90/B10 at 25 °C	35000 h
Number of switching cycles	100000

<sup>1)</sup> t[h]: L70 / B50 @ 25 °C (Ta), t[h]: L80 / B10 @ 25 °C (Ta), t[h]: L90 / B10 @ 25 °C (Ta)

## Control gear

Output current	1100 mA
ECG - Output ripple current	< 35 %

## Certificates & Standards













Standards	CE / CB / ENEC / EAC / RoHS / EPD
Luminaire with limited surface temperature, "D sign"	No







Ball shot safe	No
EPD	LEDV-00017-V01.01-EN
Replaceable light source (EPREL)	Not replaceable



### Safety advice

– Max. wind load surface 0.124 m<sup>2</sup>

### DOWNLOAD DATA

Documents and certificates		Document name
	User instruction / safety instructions	UI FL PFM 65W - 200 W
	Legal information	LSI FL PFM SYM
	Legal information	LSI FL PFM SYM
	Legal information	Legal Insert FL PFM
	Legal information	Informationstext 18 Abs 4 ElektroG
	Declarations of conformity	FLOODLIGHT PFM
	Declarations of conformity UKCA	FL PFM SYM
Photometric and lighting design files		Document name
	IES file (IES)	FL PFM 200W4000K SYM 100 BK
	IES file (IES)	FL PFM 200W 4000K SYM 100 BK
	LDT file (Eulumdat)	FL PFM 200W4000K SYM 100 BK
	LDT file (Eulumdat)	FL PFM 200W 4000K SYM 100 BK
	ULD file (DIALux)	FL PFM 200W-4000K SYM 100 BK

Photometric and lighting design files		Document name
	ROLF file (RELUX)	FL PFM 200W-4000K SYM
	UGR file (UGR table)	FL PFM 200W4000K SYM 100 BK
	UGR file (UGR table)	FL PFM 200W 4000K SYM 100 BK
	Light distribution curve type cone	FL PFM 200W4000K SYM 100 BK
	Light distribution curve type cone	FL PFM 200W 4000K SYM 100 BK
	Light distribution curve type polar	FL PFM 200W4000K SYM 100 BK
	Light distribution curve type polar	FL PFM 200W 4000K SYM 100 BK

CAD/BIM files		Document name
	BIM Revit 3D	Floodlight G3
	CAD STEP 3D	FL G3 200W

Tender texts		Document name
	Tender documents	FLOODLIGHT 200 W 4000 K SYM 100 BK-EN

**LOGISTICAL DATA**

Product code	Packaging unit (Pieces/Unit)	Dimensions (length x width x height)	Gross weight	Volume
4058075423763	Shipping box 1	407 mm x 95 mm x 516 mm	6665.00 g	19.95 dm <sup>3</sup>

The mentioned product code describes the smallest quantity unit which can be ordered. One shipping unit can contain one or more single products. When placing an order, for the quantity please enter single or multiples of a shipping unit.

**ADDITIONAL CATALOG INFORMATION**

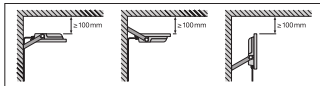
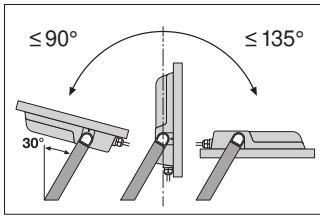

	A	B	C	LED	Area
65W	150	108	8.5	2x MB	0,046m <sup>2</sup>
80W	150	108	10,5	2x M10	0,061m <sup>2</sup>
125W	170	118	10,5	2x M10	0,083m <sup>2</sup>
165W	170	118	12,5	2x M12	0,102m <sup>2</sup>
200W	170	118	12,5	2x M12	0,124m <sup>2</sup>

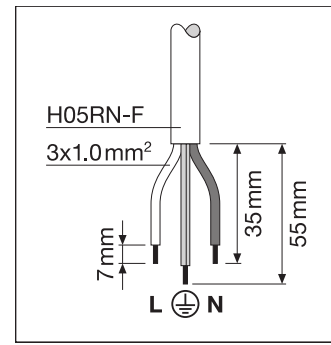

### References / Links

– For Guarantee see [www.ledvance.com/guarantee](http://www.ledvance.com/guarantee)

### DISCLAIMER

Subject to change without notice. Errors and omission excepted. Always make sure to use the most recent release.