

PRODUCT DATASHEET

HB ALU REFLECTOR 87W

HIGH BAY REFLECTOR GEN 4 | Reflectors for HIGH BAY GEN 4 luminaires



Product features

- High-quality aluminum reflector

TECHNICAL DATA

Photometrical data

Beam angle	70 °
------------	------

Dimensions & Weight

Diameter	415 mm
Height	205 mm
Product weight	340.00 g

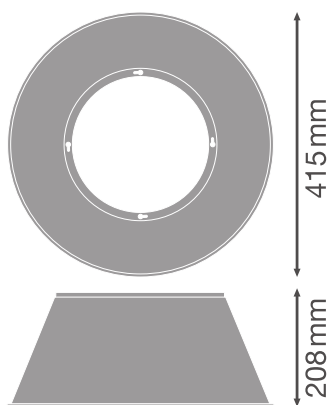

HB ALU REFLECTOR 93W

Materials & Colors

Product color	Silver
Body material	Aluminum

Application & Mounting









Protection class IK (shock resistance)	IK08
Mounting location	Luminaire

Certificates & Standards

Luminaire with limited surface temperature, "D sign"	No
Ball shot safe	No

DOWNLOAD DATA

Documents and certificates		Document name
	User instruction / safety instructions	UI HIGHBAY GEN 4

Photometric and lighting design files		Document name
	IES file (IES)	HB P 87W 840 70DEG IP65 WITH REFLECTOR
	IES file (IES)	HB P 87W 840 110DEG IP65 WITH REFLECTOR
	IES file (IES)	HB P 87W 865 70DEG IP65 WITH REFLECTOR
	IES file (IES)	HB P 87W 865 110DEG IP65 WITH REFLECTOR
	LDT file (Eulumdat)	HB P 87W 840 70DEG IP65 WITH REFLECTOR
	LDT file (Eulumdat)	HB P 87W 840 110DEG IP65 WITH REFLECTOR
	LDT file (Eulumdat)	HB P 87W 865 70DEG IP65 WITH REFLECTOR
	LDT file (Eulumdat)	HB P 87W 865 110DEG IP65 WITH REFLECTOR

Tender texts	Document name
 Tender documents	HIGH BAY REFLECTOR GEN 4 87W-EN

LOGISTICAL DATA

Product code	Packaging unit (Pieces/Unit)	Dimensions (length x width x height)	Gross weight	Volume
4058075699397	BAG 1		342.00 g	
4058075699403	Shipping box 2	462 mm x 469 mm x 247 mm	1700.00 g	53.52 dm ³

The mentioned product code describes the smallest quantity unit which can be ordered. One shipping unit can contain one or more single products. When placing an order, for the quantity please enter single or multiples of a shipping unit.

References / Links

– For Guarantee see www.ledvance.com/guarantee

DISCLAIMER

Subject to change without notice. Errors and omission excepted. Always make sure to use the most recent release.